

Relay Global

PRODUCT GUIDE 2024

The image features a dark background with vibrant, colorful brushstrokes in shades of yellow, orange, red, purple, and blue. The word "relay" is written in a stylized, lowercase, grey font. A registered trademark symbol (®) is located to the right of the word. Below the word, the website address "www.relay.global" is written in a smaller, white, lowercase font.

relay[®]

www.relay.global



Relay Global is more than a wholesale company...

We're your dedicated partner in sourcing and delivering top-quality products and exceptional service to the decorating, hardware, homeware, and gardening markets in Ireland.

We offer an unparalleled product portfolio with over 4,500 products sourced from 14 countries, catering to the needs of our customers.

We invite you to explore our Product Guide 2024, experience our exceptional service, and join us on a journey of growth and shared success. Thank you for choosing Relay Global as your trusted wholesale partner.

Have you connected
with us?

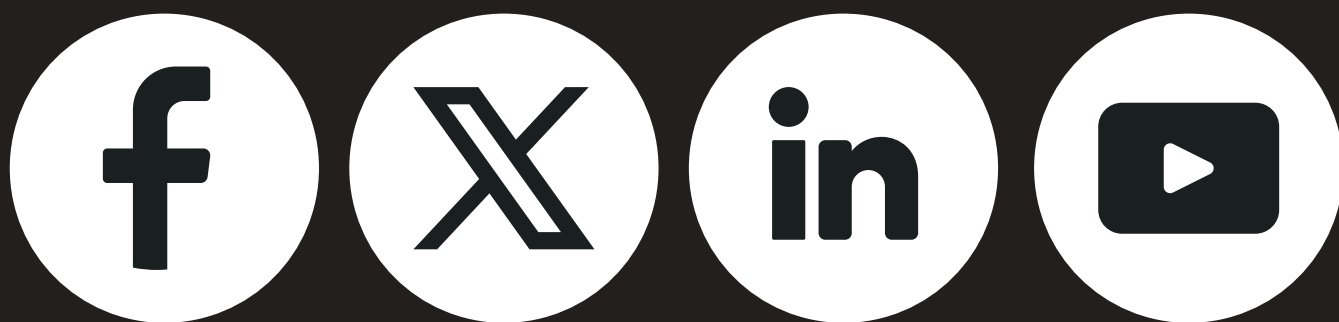

Make sure you follow our social pages
to stay up to date with exciting news
and new product announcements!

You'll always find a warm welcome...

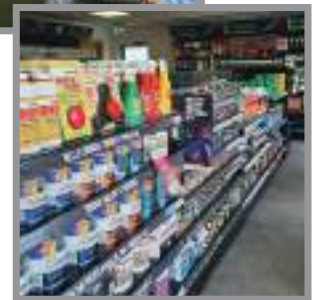
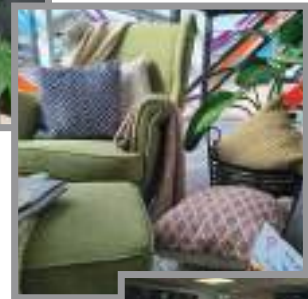
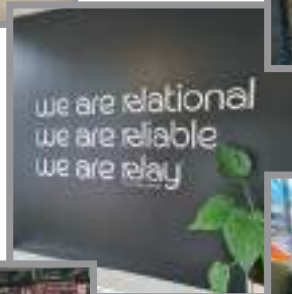

Our showroom is always open to visitors!

Get in touch with us to schedule your personal visit and prepare to be amazed by all that we have to show you!

we are relational we are reliable we are relay®

www.relay.global

Meet our ever-expanding team, who embody our values of Truthful, Respectful, Resourceful, Reliable, and Willing; while focusing on our mission of engendering trust, transmitting enthusiasm and presenting solutions to our customers, suppliers and staff. As a sales and marketing company, we stay agile and live up to our motto, 'We are relational, we are reliable, we are Relay,' which reflects our commitment to building relationships and ensuring reliability.



CAROLINE BICKERSTAFF
CUSTOMER SERVICE MANAGER
caroline.bickerstaff@relay.global



MICHAEL CARLESS
CUSTOMER SERVICE EXECUTIVE
michael.carless@relay.global



JOHN FRANCIS COLLINS
AREA SALES MANAGER
johnfrancis.collins@relay.global



SIMON DORE
OPERATIONS SPECIALIST
simon.dore@relay.global



DAMIAN HAMILTON
MERCHANTISER
damian.hamilton@relay.global



LEONARD HAMILTON
MANAGING DIRECTOR
leonard.hamilton@relay.global



NATHAN HAMILTON
MARKETING DIRECTOR
nathan.hamilton@relay.global



SAFFRON HAMILTON
PURCHASING ASSISTANT
saffron.hamilton@relay.global



STEVE HUGHES
CUSTOMER SERVICE EXECUTIVE
steve.hughes@relay.global

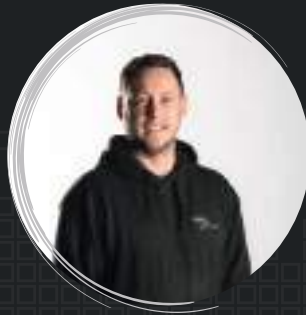

SIMON HULL
OPERATIONS MANAGER
simon.hull@relay.global



GARY HUTCHINS
BUSINESS DEVELOPMENT MANAGER
gary.hutchins@relay.global



ANTHONY MAGINESS
OPERATIONS TEAM LEADER
anthony.maginess@relay.global



KEITH MCCORMACK
AREA SALES MANAGER
keith.mccormack@relay.global



AARON MCMAHON
WAREHOUSE OPERATIVE
aaron.mcmahon@relay.global



LINETTE MCMULLAN
FINANCE ASSISTANT
linette.mcmullan@relay.global



LISA MCMULLAN
SALES SUPPORT EXECUTIVE
lisa.mcmullan@relay.global



STEPHEN MCMULLAN
OPERATIONS SPECIALIST
stephen.mcmullan@relay.global



FERGUS POCOCK
BUSINESS DEVELOPMENT MANAGER
fergus.pocock@relay.global



JOEY SHERIDAN
FINANCE DIRECTOR
joey.sheridan@relay.global



MICHAEL TAYLOR
SALES & KEY ACCOUNT MANAGER
michael.taylor@relay.global



COLIN TEENEY
CUSTOMER SERVICE EXECUTIVE
colin.teeney@relay.global



Want to join our team?
We're always hiring, so contact us today with your CV!

CONTENTS

2024



Abrasives	74-75, 105, 127
Chemicals	26, 29, 37, 50, 58-59, 61-63, 108
Fillers	64-73, 108
Fire Protection	39-41
Masking	78, 106-107
Paints & Coatings	19-26, 30-39, 42-57, 85, 108
Tools & Accessories	79-127
Wallpapering	27, 60, 76-77, 126

PAINT GUIDE

Look out for these symbols throughout this publication which show at a glance what type of base the coating has.



WATER BASED



SOLVENT BASED



SHELLAC BASED



Adhesives & Chemicals	160-166
Brooms	134-138
Car Care	168-172
Doormats	230-247
Electrical	148-158
Fireside	207-226
Mail Boxes	139-141, 253
Pet Care	250-251
Pest Control	174-205
Surface Protection	145-147
Technical Hoses	144
Tools	130-132



Bins	289, 330-336
Cleaning	257-276
Display	337
Disposables	292-297
Doormats	338-389
Kitchen Equipment	290-291, 298-327
Laundry	277-283, 288
Soft Furnishings	392-401



Bird Care	405-415
Chemicals & Pest Control	457-465
Edging	424-425
Planters	418-421
Sundries	421, 425, 457
Tools	426-435
Watering	422, 437-456



Zeroflame:	40-41
Petersons:	
- Premier	82-85
- Predator	86-91
- Profile	92-93
- Paragon	94-109
- Praxis	110-117
Castle Living:	
- Cleaning	142
- Fireside	206-226
Gardag:	
- Brooms	133-138
- Mail Boxes	139-141
- Planters	418-419

All items are subject to availability. Images shown are for display purposes only.





DECORATING 2024

**ZINSSER'S
PRIMED
FOR THE
FUTURE.**



ZINSSER
MAINTENANCE SOLUTIONS

**B·I·N
AQUA**

ADVANCED WATER-BASED
PRIMER, SEALER, STAIN KILLER &
ODOR BLOCKER

EFFECTIVELY BLOCKS ODORS,
MOLD, KNOTS & SAP STAINS

2.5L

NET VOLUME

84.5 FL. OZ.

10 Min
Dry Time

45 Min
Recoat



The 1940's Zinsser® factory & offices, New York City.



A 1930's Zinsser® Bulls Eye Shellac poster.

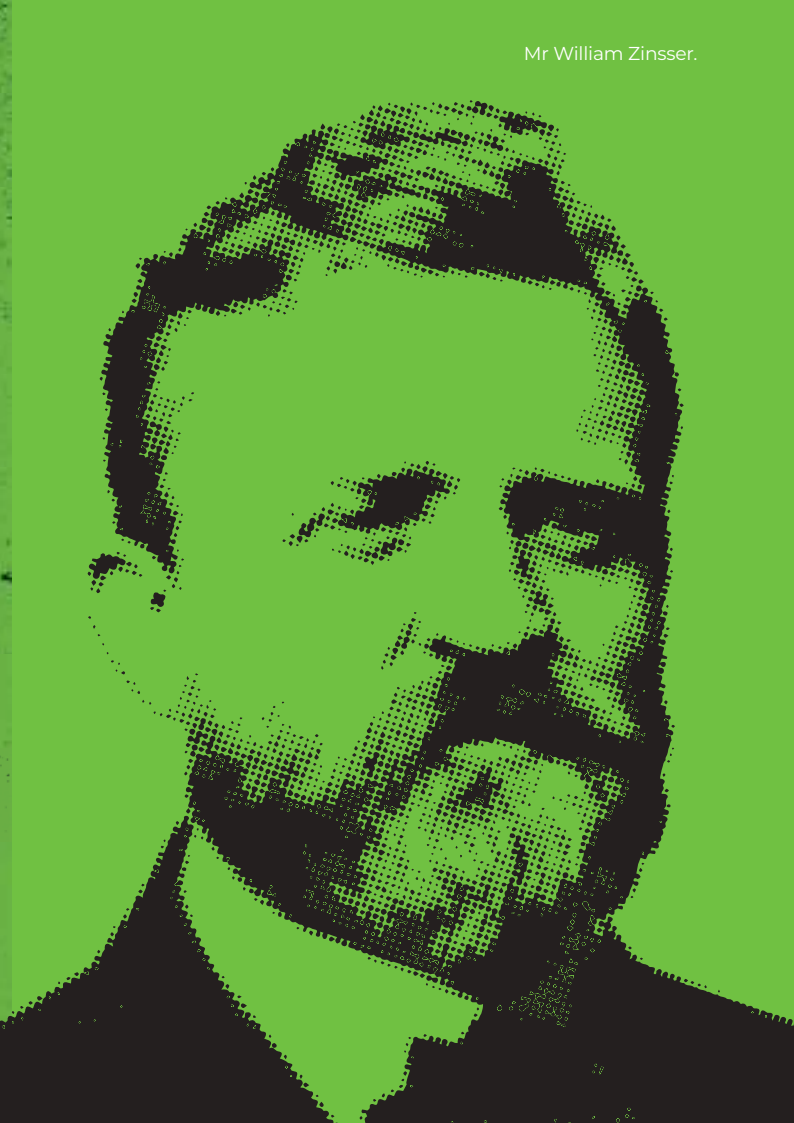

Mr William Zinsser.

A LEGACY OF LEGENDARY INNOVATION.

Founded by William Zinsser (left) in 1849, ours is the pioneering brand that introduced shellac finishes to the US market.

The success of our shellac based products led to the launch of a groundbreaking 4-in-1 primer named Bulls Eye – now known as B-I-N® – that is universally respected by professional painters the world over.

For nearly 175 years, Zinsser® has been at the forefront of specialist primer technology and is responsible for many market firsts including Bulls-Eye® 1-2-3, the world's first all-purpose water-based primer-sealer.



An original 1982 US Zinsser® Bulls Eye® 1-2-3 pack design.

THE LEGEND CONTINUES...

At Zinsser®, we're committed to creating innovative and top-quality paint products that have minimal environmental impact, all while meeting the needs of professional painters.

In depth research and development over the last decade has led us to the launch of our newest innovation: **B-I-N® AQUA**.

B-I-N® AQUA is a groundbreaking, water-based, 4-in-1 primer, that offers the same trusted performance advantages as our renowned B-I-N® and more.

"B-I-N® AQUA has the lowest practicable level of VOCs. It offers the same trusted performance as Zinsser B-I-N® in a water-based formula."

*Andy Shaw,
Technical Director, Zinsser(UK).*

MAXIMUM PERFORMANCE. TRACE VOCs.

As regulations and the environmental consciousness of painters evolve, manufacturers like us are challenged to reduce the amount of volatile organic compounds (VOCs) in our products. We're fully committed to this cause for the long term.

Our mission with **B-I-N® AQUA** was to achieve the lowest practicable VOC level and we've succeeded. With less than 0.1% VOCs, **B-I-N® AQUA** achieves the British Coatings Federation's Trace VOC Globe, highlighting the product as having the lowest practicable level of VOCs.

As a manufacturer certified to ISO14001:2015, our commitment to environmentally responsible practices has been further acknowledged with our 2021 Silver EcoVadis medal in recognition of sustainability.

Through the adoption of a water base and the replacement of shellac (the active component in our original B-I-N® formula) with a highly durable and robust resin, we've been able to maintain the same level of excellent performance, while offering the added advantage of outdoor use. This is limited to spot application in the original Zinsser® B-I-N®.





KINDER TO THE ENVIRONMENT.

The innovative water-based formula contains only trace elements of VOCs (<0.1%).



KINDER TO YOUR PAINTBRUSH.

Easy soap & water clean-up that's less abrasive to your brush or roller.



A BREATH OF FRESH AIR.

Ultra-low odour makes for more comfortable paint application.



4-in-1 PRIMER-SEALER.

Effectively primes, seals, blocks stains & locks in problem odours.



START FAST, FINISH FASTER.

Lightning fast drying time of 25 minutes, recoatable in 45 minutes.



EXCELLENCE INSIDE & OUT.

Suitable for a wide range of interior/exterior applications.

MULTI-SURFACE. MULTI-PURPOSE.

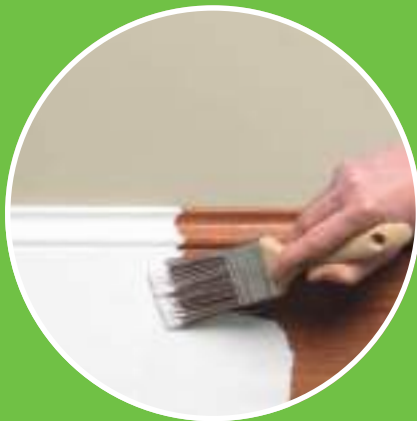

VARNISH.

With an advanced, high-hiding formulation, **B-I-N[®] AQUA** can be used as a full-surface primer on varnish, glossy paint, wood panels, building boards, PVC, plywood, concrete & more.



STAINS & TANNIN BLEED.

B-I-N[®] AQUA's specialist, stain-killing formula efficiently blocks tannin bleed & water, grease, oil, mildew, crayon & lipstick stains.



KNOTS & SAP STREAKS.

B-I-N[®] AQUA delivers effective knot blocking & seals resin and sap streaks.



SMOKE & FIRE.

Brilliant for priming damaged surfaces, **B-I-N[®] AQUA** blocks smoke stains & seals odours from fire damage, nicotine, soot, fireplaces & heaters.



Product No	Size	Pack
ZN615042	500ml	6
ZN615035	1L	6
ZN615028	2.5L	4
ZN615011	5L	2



B-I-N



BEST SELLER



Since 1946 professional decorators have been using B-I-N Primer Sealer to seal the worst stains and block the worst odours. Today, over 70 years later, it is still the ultimate performance primer. B-I-N has a unique shellac based formula which gives it unsurpassed stain killing power – water stains, smoke damage, crayon – you name it, B-I-N will block it.

In addition to blocking the stain, B-I-N also permanently blocks the odour – another great ‘plus’ particularly for restoration work after flooding or fire damage.

- Shellac based
- Premier stain blocker - blocks water stains, smoke stains, etc
- Completely seals in odours
- Dries in 15 minutes, can be recoated in 45 minutes
- Primes and seals all interior surfaces
- Bonds tightly to glossy surfaces
- Compatible with latex, alkyd, epoxy, lacquer and other finishes
- Tintable
- Theoretical coverage 12.5m²/litre

Product No	Size	Pack
ZN610184	500ml	6
ZN610177	1L	6
ZN610160	2.5L	4
ZN610153	5L	2
ZN610146	10L	1

Aerosol

Product No	Size	Pack
ZN610467	400ml	6

Grey

Product No	Size	Pack
ZN614939	1L	6
ZN614946	2.5L	4

Bulls Eye 1-2-3



Made with Zinsser's unique proprietary acrylic resins for exceptional flexibility and durability. Bulls Eye 1-2-3 can be used under or over any oil or latex paint and will bond to virtually any surface. Its adhesion characteristics are legendary – gloss paint, PVC, ceramic tiles, glass, lead, galvanised metal – it takes them all in its stride without the need of time consuming sanding, just make sure the surface is thoroughly cleaned and degreased first.

- Water based
- Interior and exterior use
- Bonds to all surfaces including glossy and hard-to-paint surfaces such as ceramic tiles, galvanising, aluminium, glass, gloss paint, PVC, lead, etc
- No prior sanding needed to produce a ‘key’
- Compatible with water-based or oil-based top coats
- Seals all porous surfaces
- Superior stain blocking
- Low odour, fast drying and tintable
- Dry film is breathable and flexible – resists cracking and peeling
- Deep tint version available for dark colours
- Theoretical coverage 10m²/litre

Product No	Size	Pack
ZN610238	500ml	6
ZN610221	1L	6
ZN610214	2.5L	4
ZN610207	5L	2
ZN610191	10L	1

Deep Tint Base

Product No	Size	Pack
ZN612362	500ml	6
ZN610443	1L	6
ZN610450	2.5L	4

Grey

Product No	Size	Pack
ZN614045	500ml	6
ZN614052	1L	6
ZN614069	2.5L	4

Cover Stain



This unique oil-based primer is formulated to dry in 30 minutes and yet remain flexible and durable enough for priming a wide variety of interior and exterior surfaces. Cover Stain is breathable for best exterior performance and is an effective stain barrier. For painters who prefer and need oil base performance, Cover Stain will provide top quality results and has great application properties. Cover Stain is also a good ‘winter use’ alternative to Bulls Eye 1-2-3 as it can be used at lower temperatures.

- Solvent based
- Interior and exterior use
- Stain killer and tannin blocker
- Excellent enamel undercoater
- Multi-surface primer
- Bonds to high gloss surfaces
- Ideal for new construction
- Great sprayability
- Can be used in low temperatures
- Seals porous surfaces
- Compatible with oil-based or water-based top coats
- Deep tint version available for dark colours
- Theoretical coverage 10m²/litre

Product No	Size	Pack
ZN610283	500ml	6
ZN610276	1L	6
ZN610269	2.5L	4
ZN610252	5L	2
ZN610245	10L	1

Aerosol

Product No	Size	Pack
ZN610474	400ml	6

Deep Tint Base

Product No	Size	Pack
ZN612393	500ml	6
ZN612386	1L	6
ZN612379	2.5L	4

Bulls Eye 1-2-3 Plus



Bulls Eye 1-2-3 Plus is a next generation universal water-based primer, sealer and stainkiller. It is ideal for interior and exterior painting projects. Bulls Eye 1-2-3 Plus delivers performance benefits normally only associated with solvent-based primers, including exceptional adhesion and stain blocking. No other water-based primer delivers the stain blocking power of Bulls Eye 1-2-3 Plus. It is specially formulated to resist re-wetting, meaning it can block water soluble stains like a solvent-based primer and seal oil-soluble stains, meaning painting projects can be completed with just one primer. Uniquely, it can be applied directly over water and smoke stains. Bulls Eye 1-2-3 Plus delivers unparalleled adhesion and deals effortlessly with hard to paint interior and exterior substrates such as glossy surfaces, ceramic tiles, non-ferrous metal (such as aluminium, stainless steel and galvanised metal), vinyl, hardboard, melamine, varnish, plastic, GRP, UPVC, wood, masonry and more. Also contains a biocide that protects the dried coating against fungal degradation, making it ideal for high-humidity areas such as bathrooms and laundry rooms. It offers effective resistance to fungal degradation on the underside and surface of the primer film, prolonging the life of the paint job. All of the above benefits combine with ultra low VOC content, a lightning quick drying time of just 30 minutes and a 1 hour recoat time.

- Low odour, water-based formula
- Primer, sealer and stainkiller
- Unrivalled adhesion
- Blocks the toughest of stains - even water and smoke
- For any interior or exterior surface
- Dries in 30 mins, recoat in 1 hour
- 12.5pH Alkali resistant
- Ultra low VOC
- Theoretical coverage 10m²/litre

Product No	Size	Pack
ZN610801	1L	6
ZN610818	2.5L	4
ZN610825	5L	2

Peel Stop



Peel Stop is a clear, flexible bridging sealer for surfaces where peeling, flaking, dusting or chalking is a problem. Use indoors or out to form a breathable membrane over questionable or faulty substrates.

Peel Stop tightly bonds to old paint and problem areas forming a sound surface for new paint. Peel Stop forms a tough acrylic film that stays flexible and helps prevent peeling by letting moisture escape. A clear sealer, Peel Stop works like nothing else to stop peeling problems on old or new surfaces.

Recommended uses: prevents peeling, blistering, checking, cracking and flaking on wood siding and trim, yellow pine, rough sawn cedar, textured plywood, chalking or powdering, concrete and concrete block, stucco and galvanized gutters.

- Extend the life of problem surfaces
- Binds cracking, chalking and peeling paint
- Glues down cracks and gaps under edges of old paint before repainting
- Dries clear
- Interior and exterior use
- Recoat in 2 hours
- Soap and water cleanup
- Flexible and breathable
- Theoretical coverage 8m²/litre

Product No	Size	Pack
ZN612010	1L	6
ZN614106	2.5L	4
ZN612003	5L	2

Gardz



A unique water-based sealer for porous and potential problem surfaces. Gardz is formulated to deeply penetrate and dry to a hard, moisture resistant film that seals and binds down porous, chalky and crumbling surfaces, paints and textured finishes.

Gardz takes the 'problem' out of problem surfaces. Deeply penetrating, it dries to a rock-hard, water-resistant finish; this protects surfaces from damage during the next redecorating project.

Gardz is recommended for damaged drywall, new drywall, spackling and joint compound skim coats, plaster, calcimine, uncoated wallpaper, wallcovering adhesive residue, textured paint and more.

- Repairs torn paper on damaged drywall, and eliminates bubbles
- Seals old wallpaper adhesive
- Low odour
- Dries clear
- Dries fast to a hard, moisture-proof film
- Binds down chalky surfaces
- Can be applied to high-pH surfaces
- Cleans up with soap and water
- Theoretical coverage 9m²/litre

Product No	Size	Pack
ZN612119	500ml	6
ZN612102	1L	6
ZN612096	2.5L	4
ZN610795	5L	2

AllClean



A highly durable, scrubbable, stain resistant, flat matt finish with flawless, even coverage. Protects against scuffs and stains. For use in homes, schools or commercial buildings, AllClean is great for ceilings and walls in any interior area. Unlike ordinary paints, AllClean produces a tough, scrubbable finish that withstands stains, moisture and resists dirt pickup, keeping the painted finish looking fresher for longer. Ideal for new or previously painted wallboard, plaster ceilings and walls. Perfect for busy environments that require frequent cleaning.

- ISO 11998 Class 1 Wet Scrub-Rated
- Scuff and scrub resistant
- Stain resistant
- Interior application
- Class 0 fire rated
- Streak-free
- Flawless matt finish
- Easy clean
- Washable
- Theoretical coverage 10m²/litre

AllClean is available tinted to any RAL, NCS or BS4800 colour. Contact us for details and pricing.

Product No	Colour	Size	Pack
ZN614816	Brilliant White	2.5L	4
ZN614809	Brilliant White	5L	2

Perma-White



Mould and mildew thrive in the moderate, damp Irish climate, particularly in the modern building with its reduced air movement. Perma-White is the answer. Perma-White is a high performance, self-priming, latex acrylic paint that is guaranteed to protect the paint film from growth of mould and mildew for at least seven years. Perma-White produces a tough, scrubbable finish that withstands moisture and resists dirt pick-up – key conditions that promote mould and mildew growth on the paint film and eventually cause paint failure. Two coats are required for full mould and mildew protection.

- 7 year performance
- Self-priming two coat system
- Low odour and tintable
- Fast drying
- Blister proof
- Moisture resistant
- Washable, scrubbable
- Two finishes available
- Theoretical coverage 12m²/litre

Matt

Product No	Size	Pack
ZN610399	1L	6
ZN610382	2.5L	4
ZN610375	5L	2
ZN610368	10L	1

Satin

Product No	Size	Pack
ZN610351	1L	6
ZN610344	2.5L	4
ZN610337	5L	2
ZN610320	10L	1

Grade 1



Grade 1 is a high performance primer, sealer and finish for the interior decoration of walls and ceilings in traditional and historic buildings, including churches, castles and period properties.

Grade 1 can be applied to: plaster, concrete, mortar, chalky materials, distemper, limewash and whitewash on: walls, ceilings, doors, trims, windows and cabinetry.

- Zero tension paint film
- Up to 8 years' performance
- One-can system
- Quick drying
- Primer, sealer and finish in one
- Blocks and seals stains
- Protects against mould and mildew
- Virtually odourless
- Vapour permeable
- Durable and washable
- Flat matt white finish
- Tintable
- Theoretical coverage 10m²/litre

Perma-White Interior and Grade 1 are available tinted to any RAL, NCS or BS4800 colour. Contact us for details and pricing.

Product No	Size	Pack
ZN612232	2.5L	4
ZN612249	5L	2
ZN612256	10L	1

Ceiling Pro 5-in-1

Ceiling Pro 5-in-1 is based on ground-breaking paint technology that effortlessly provides a perfectly finished ceiling every time. It adheres to any surface, seals stains (including water and smoke stains), primes and finishes whilst bridging hairline cracks. In addition, Ceiling Pro 5-in-1 contains a biocide that protects the dried coating against fungal degradation, prolonging the life of the painted ceiling.

- 5-in-1 - primes, seals, blocks stains, finishes and covers cracks*
- Like no other product on market - no other products offer stain blocking properties alongside filling cracks or stain cover and finish in one
- Flat white non-yellowing finish
- For bare and previously painted ceilings
- Touch dry in 30 minutes - re-coat in 1 hour
- Low odour
- Ultra low VOC content
- Theoretical coverage 10m²/litre

*Product will cover over and bridge hairline cracks in the surface of the plaster.



Product No	Size	Pack
ZN614137	2.5L	4



Drywall Pro 2-in-1

Drywall Pro 2-in-1 is a unique priming and sealing system for preparing new or damaged drywall, plaster and porous surfaces for painting, wallpapering, texturing and other decorative projects. Drywall Pro 2-in-1 penetrates and seals these surfaces to create a sound, water-resistant and trouble-free foundation for painting, wallpapering, texturing and other projects.

- White finish
- High-hiding formulation
- Alkali resistant
- Prevents bubbling
- No damage on redecoration when removing contract vinyl wallpaper
- Low odour
- Protects drywall against water-based paints and adhesives
- No other product combines priming and sealing properties
- Touch dry in 30 minutes - re-coat in 3 hours
- Theoretical coverage 9-11m²/litre



Product No	Size	Pack
ZN614113	5L	2



Wallpaper Cover-Up

Wallpaper Cover-Up is an all-in-one primer, sealer and stain blocker. A high hiding primer that obliterates wallpaper print with a smooth matt off-white finish. Can be used under any coloured emulsion. Wallpaper Cover-Up can be applied by either brush or roller - for best results use a short pile mohair or microfiber roller. Unlike a regular emulsion which can cause wallpaper to bubble and blister, Wallpaper Cover-Up seals the wallpaper. This one-coat system creates a new surface that's easy to paint. Wallpaper Cover-Up also includes a stain blocker, which means that seeping stains from smoke and damp residue are easily covered with no fear of re-emergence.

- Obliterates wallpaper print
- Prevents blistering of wallpaper
- Blocks water soluble stains
- Re-coat in 4 hours
- Theoretical coverage 5-8m²/litre



Product No	Size	Pack
ZN614021	2.5L	4



Write-On Paint

Write-On Paint is a white coating that transforms ordinary walls into a dry-wipe surface. After simple installation, any standard dry-wipe markers* can be used on the surface. Ideal for use on painted interior surfaces such as: plasterboard, hardboard, wood, cement and metal. Perfect for use in schools, colleges, universities, offices - one pack covers 30m² in just a single coat application. For best results apply over a pre-painted, white or light coloured surface. If applying to a new surface, use a suitable white, water-based primer first, e.g. Zinsser Bulls Eye 1-2-3.

- For professional use (schools, offices etc)
- 2 pack system (base coat and activator)
- Kit includes microfiber roller
- Dries in 4 hours, writeable in 5 days
- 1 coat application
- Tough and durable
- Indoor use
- Compatible with standard dry wipe markers* and cleaners
- 1 kit will cover 30m²

*Whilst most dry wipe markers are suitable it is recommended to check ease of removal of the chosen dry wipe marker pens on a small test area first.



Product No	Pack
ZN614083	1



AllCoat Exterior Water Base

AllCoat Exterior is an ultimate performance paint that offers supreme protection to all exterior surfaces. It forms a vapour-permeable, low maintenance, water-shedding tough finish that is recoatable in just 1 hour. Available in white, black and tinted to any colour. The paint is self priming and can be applied to previously painted surfaces without sanding.

- 15 year performance
- Excellent colour retention
- Multi-surface application - glossy paints, bitumen, tar, varnish, creosote, Platisol, powder coatings, timber, metal, concrete and glossy paints
- Available in BS, RAL and NCS colours
- Flexible and micro porous with excellent resistance against cracking, blistering and flaking
- Quick drying, self priming water borne system that can be finished in a day
- Contains a biocide to protect the dried coating against fungal degradation
- Theoretical coverage 12m²/litre



Product No	Colour	Finish	Size	Pack
ZN612140	White	Satin	1L	6
ZN612133	White	Satin	2.5L	4
ZN612126	White	Satin	5L	2
ZN614434	White	Satin	10L	1
ZN614090	Black	Satin	500ml	6
ZN612171	Black	Satin	1L	6
ZN612164	Black	Satin	2.5L	4
ZN612157	Black	Satin	5L	2
ZN614793	Anthracite	Satin	1L	6
ZN614786	Anthracite	Satin	2.5L	4
ZN614779	Anthracite	Satin	5L	2
ZN612447	White	Gloss	1L	6
ZN612454	White	Gloss	2.5L	4
ZN612546	White	Gloss	5L	2
ZN612461	Black	Gloss	1L	6
ZN612478	Black	Gloss	2.5L	4
ZN612553	Black	Gloss	5L	2
ZN614304	White	Matt	1L	6
ZN614311	White	Matt	2.5L	4
ZN614151	White	Matt	5L	2
ZN614472	White	Matt	10L	1
ZN614328	Black	Matt	1L	6
ZN614168	Black	Matt	2.5L	4

All AllCoat products are available tinted to any RAL, NCS or BS4800 colour. Contact us for details and pricing.

AllCoat Exterior Solvent Base

Gives excellent resistance against cracking, blistering and flaking for up to 15 years before first maintenance. The tough finish is resistant to rain and severe weather and offers excellent colour retention, and the paint contains a biocide to protect the dried coating against fungal degradation. In addition, it dries even in low temperatures (down to 5°C) and is resistant to showers after 1 hour. After removing any existing mould and mildew, two coats of AllCoat Exterior Solvent Base will ensure that any exterior looks bright and beautiful for years.

- Multi-surface application
- Low temperature application, down to 5°C
- Weather resistant silicon alkyd formula
- Excellent colour retention and resistance to yellowing
- Long lasting finish - up to 15 years performance
- Resistant to showers after 1 hour
- Recoatable in 3 hours
- Theoretical coverage 10m²/litre



Product No	Colour	Finish	Size	Pack
ZN614205	White	Satin	1L	6
ZN614212	White	Satin	2.5L	4
ZN614397	White	Satin	5L	2
ZN614229	Black	Satin	1L	6
ZN614236	Black	Satin	2.5L	4
ZN614519	White	Gloss	1L	6
ZN614526	White	Gloss	2.5L	4
ZN614533	Black	Gloss	1L	6
ZN614540	Black	Gloss	2.5L	4

All AllCoat products are available tinted to any RAL, NCS or BS4800 colour. Contact us for details and pricing.

AllCoat Interior

- Primer and finish in one product
- Sticks to all surfaces without sanding
- Ideal for new plaster and other surfaces with up to 12.5 pH
- Will not raise the grain of new wood
- Sands crisply to a powder within 2 hours
- Very low odour
- Dead flat finish
- Self priming on porous surfaces due to high resin content
- High hiding formula
- Theoretical coverage 10m²/litre



Product No	Size	Pack
ZN612041	1L	6
ZN612430	2.5L	4
ZN610306	5L	2
ZN610290	10L	1

AllCoat Commercial

- Primer and finish in one product
- Suitable for most surfaces: wood, concrete, plasterboard, Plasticol and galvanised steel
- Great adhesion to previously finished glossy surfaces
- Resists grain raise on new wood
- Low odour
- Fast drying
- Theoretical coverage 10m²/litre



Product No	Colour	Size	Pack
ZN610313	White	10L	1
ZN610429	Black	10L	1

AllWeather Exterior Masonry Paint

- Based on Pliolite resins
- 15 year performance
- Flat matt breathable finish
- Resists dirt accumulation
- Can be applied to -5°C
- Showerproof in 20 minutes - 3 hour recoat
- For bare or previously painted concrete, render, stone and brickwork
- The paint film is designed to resist cracking, peeling and blistering for up to 15 years before first maintenance
- AllWeather is available tinted to any RAL, NCS or BS4800 colour. Contact us for details and pricing.
- Theoretical coverage 12m²/litre



Product No	Colour	Finish	Size	Pack
ZN614632	White	Satin	5L	2
ZN614649	Black	Satin	5L	2

WaterTite

- Keeps water out and mildew away
- Lifetime waterproof guarantee
- Stops up to 34psi of water pressure
- Smooth non-gritty finish
- Prevents recurring efflorescence
- Ultra low-odour formula
- Tintable
- Re-coat in 4 hours
- Can be applied to wet surfaces
- Theoretical coverage 2m²/litre



Product No	Size	Pack
ZN610412	5L	2
ZN610405	10L	1

Covers Up

- Innovative vertical spraying aerosol – great for blocking stains on ceilings
- Dries flat white
- Matches the colour of most ceiling tiles
- Sticks to all surfaces without sanding
- Primer and finish in one product
- Seals water and smoke stains
- High hiding capabilities
- Non-yellowing
- Oil based
- Theoretical coverage 1.5m²/400ml



Product No	Size	Pack
ZN610481	400ml	6

SealCoat

- Universal sanding sealer
- Pre-stain conditioner – application of SealCoat before staining prevents variations in stain finish
- Bond coat between existing and new clear finishes
- Compatible with all clear finishes
- Gives depth and beauty to wood grain
- Will not raise or swell wood grain
- Will not yellow or darken with age
- Theoretical coverage 12m²/litre



Product No	Size	Pack
70094	1L	6

Mould Killer & Remover

- Kills and removes fungi, mould and algae growth
- Suitable for all interior surfaces
- Removes mould prior to decorating
- Ideal for tiles, plaster and wallpaper
- Water-based and ready to use



Product No	Size	Pack
ZN612522A	500ml	6

Universal Degreaser & Cleaner

- Concentrated cleaner, degreaser and stain remover
- Removes tough stains fast
- Effective against grease and oil
- A water-based detergent that is colour fast, fabric safe and removes tough stains quickly and effectively from many surfaces
- Ideal for cleaning and preparing surfaces before painting



Product No	Size	Pack
ZN612539	750ml	6
ZN614670	2.5L	4

B-I-N Brush Cleaner & Restorer

- Renews and restores used and hardened brushes in just 4 hours
- Fast acting
- Much more effective than traditional mineral cleaners such as white spirit
- Removes shellac, solvent and water-based paints and varnishes



Product No	Size	Pack
ZN612508	500ml	6
ZN612515	1L	6

Paper Tiger

- Speeds up wallpaper removal
- Multi-directional wheels perforate, lift and separate sections of wallpaper from the wall allowing the stripper to penetrate and dissolve the adhesive
- Built-in automatic depth control prevents wall damage
- Cuts through one or multiple layers
- Single or triple head available



Product No	Type	Pack
02966	Single Head	6
02976	Triple Head	3

DIF Wallpaper Stripper

- Patented enzyme action wets the wallpaper and dissolves the old paste
- Easy to apply with paint roller or garden-type pump sprayer
- Liquid concentrate formula
- Cuts removal time in half
- Effectively removes residual paste
- Use along with the Zinsser Paper Tiger



Product No	Size	Pack
ZN614014	1L	6
ZN614007	2.5L	4

ZINSSER TACKLES THE TOUGHEST EXTERIORS.

Our ultimate mould resistant paint offers unrivalled protection to all exterior surfaces - wood, metal, masonry, plastic, uPVC, concrete & cladding.

- ✓ Up to 15 year performance.
- ✓ Exceptional colour retention.
- ✓ Flexible & microporous.
- ✓ Available in matt, satin & gloss finishes.
- ✓ Tintable to RAL, British Standard, NCS & custom colours.
- ✓ Ideal for airless spray application.

Contact Relay Global now to explore the legendary range.



PRODUCT COMPARISON CHART

B-I-N AQUA	BULLS EYE 123	BULLS EYE 123+	B-I-N	COVERSTAIN	
					EX = EXCELLENT VG = VERY GOOD G = GOOD NR = NOT RECOMMENDED
					Interior
EX	EX	EX	EX	EX	Drywall
EX	EX	EX	G	G	Plaster (1)
EX	EX	EX	NR	NR	Lime Plaster
EX	G	EX	EX	EX	New Wood Trim/Doors
VG	G	VG	G	EX	Plywood
EX	EX	EX	G	G	Brick
EX	EX	EX	G	G	Concrete (1)
EX	EX	EX	NR	NR	Galvanised Metal New (3)/Old
EX	EX	EX	G	G	Aluminium/Stainless Steel
EX	EX	EX	NR	NR	Fibreglass/GRP
EX	EX	EX	EX	EX	Glossy Paints/Glass
EX	NR	VG	EX	NR	Varnish/Clear Finishes
EX	NR	VG	EX	EX	Woodstain
EX	VG	VG	EX	G	Wood Panelling/Laminates
EX	EX	EX	G	G	Ceramic Tiles
EX	G	EX	EX	G	Formica
EX	EX	EX	EX	EX	Wallcovering (non-porous)
EX	EX	EX	EX	NR	Powder Coatings
EX	EX	EX	NR	NR	Acoustic Tiles



B-I-N AQUA	BULLS EYE 123	BULLS EYE 123+	B-I-N	COVERSTAIN	
					EX = EXCELLENT VG = VERY GOOD G = GOOD NR = NOT RECOMMENDED
					Exterior
VG	G	VG	*	EX	Cedar & Redwood
EX	G	EX	*	NR	Plastisol™
VG	G	VG	*	EX	Pressure Treated Wood
EX	EX	EX	*	G	Brick
EX	EX	EX	*	G	Concrete/Stucco
EX	EX	EX	*	EX	Glossy Paints
EX	EX	EX	*	NR	Galvanised Metal New (3)/Old
EX	EX	EX	*	G	Aluminium/Copper
NR	G	NR	*	EX	Wrought Iron/Cast Iron
EX	EX	EX	*	NR	Lead/Asbestos
EX	EX	EX	*	G	PVC (4)
EX	EX	EX	*	NR	Powder Coatings



B-I-N AQUA	BULLS EYE 123	BULLS EYE 123+	B-I-N	COVERSTAIN	
					EX = EXCELLENT VG = VERY GOOD G = GOOD NR = NOT RECOMMENDED
					Stains & Odours
EX	NR	VG	EX*	EX	Tannin Bleed
EX	NR	NR	EX*	NR	Knots & Sap
NR	EX	NR	EX*	G	Flash Rusting
VG	NR	VG	EX*	EX	Smoke & Fire Damage
VG	NR	G	EX*	EX	Water Damage
VG	NR	G	EX*	EX	Nicotine/Tobacco Stains
VG	NR	G	EX*	EX	Mildew/Mould Stains (2)
G	G	G	EX*	EX	Grease
EX	EX	EX	NR	NR	Tar/Bitumen/Asphalt
EX	G	EX	NR	NR	Creosote
EX	NR	NR	EX*	NR	Odour Sealing
EX	EX	EX	EX*	G	Lipstick/Crayon



- Notes: *Use B-I-N for spot priming on exterior surfaces. 1) Allow new plaster / cement & stucco to cure 60-90 days before coating.
 2) Use Zinsser Mould Killer & Remover to remove mould / mildew before priming.
 3) Degrease new galvanised steel with Zinsser Universal Degreaser & Cleaner, ensuring all traces of oil & surface contamination are removed.
 4) Unweathered powder coatings, Plastisol, UPVC & fibreglass to be abraded & degreased thoroughly before priming. Read instructions on product container for further information.

BLACKFRIAR

A TRADITION OF EXCELLENCE SINCE 1894

A Tradition Of Excellence, since 1894

The Blackfriar brand has been making its mark on the paints and varnishes industry for over one hundred and thirty years. We take a look at the origins of the business and how the product range has grown since 1894.

The Blackfriar business has its origins in the Ostrich Paint and Varnish works, established in Bristol in 1894, where founder Ernest Parsons spent eight successful years before forming his own business. In 1902 the Blackfriar name was born and the new business, E. Parsons and Co., quickly earned an excellent reputation for its woodstains and varnishes. The business grew rapidly and expanded its product range to the extent that in the 1920s it became famed for the black paints it supplied to the motor industry for use in brake shoes for cars and heavy goods vehicles. Family-owned for over 100 years, Blackfriar was built on a tradition of supplying high quality paints and woodcare products to independent merchants, craftsmen and DIY enthusiasts.

In 2004 Blackfriar became part of the Tor Coatings Group, cementing its position at the premium end of the paint and varnishes industry. Today the company manufactures and markets the Blackfriar range presented in this catalogue from its facility in County Durham, England.



Anti-Mould Solution

- Powerful mould killing solution
- Ideal for many surfaces including tiles, plaster, wallpaper, paving slabs, slate and marble
- Can be used inside or outside
- Odourless
- Will not discolour surface



Product No	Size	Pack
BF080132	500ml	6
BF080156	2.5L	4

Liquid Driers

- Good 'wintertime' product
- Add to most conventional oil-based decorative paints, polyurethanes and varnishes to speed up drying
- Particularly good in cold conditions

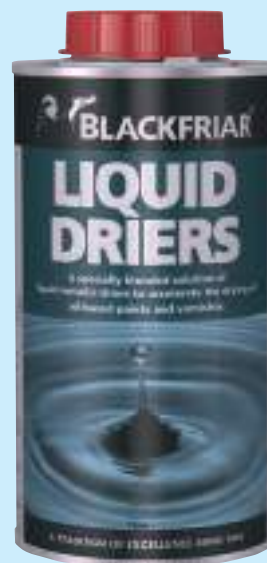

Product No	Size	Pack
BF330190	250ml	6
BF330138	500ml	6

Stabilising Solution

- Binds and seals porous and chalky surfaces
- Ideal for weathered masonry paint, chalky emulsion paint and limewash
- Provides stable substrate for painting
- Theoretical coverage 13m²/litre



Product No	Size	Pack
BF060134	500ml	6
BF060141	1L	6

Interior Seal Damp

- Protects interior surfaces from damp
- For use on plaster, brick and cement
- Dries clear
- Use under paint or wallpaper
- Theoretical coverage 13m²/litre



Product No	Size	Pack
BF380126	250ml	6
BF380133	500ml	6
BF380140	1L	6
BF380157	2.5L	4

Multi-Surface Primer

- Ideal for hard and soft woods, chipboard, plywood, GRP, MDF, exterior uPVC, ceramic tiles, iron, steel, galvanised and non-ferrous metals and old plaster
- Interior and exterior use
- Contains anti-corrosive pigment to protect iron and steel
- Touch dry in 1 hour
- Theoretical coverage 12m²/litre



Product No	Size	Pack
BF530507	250ml	6
BF530514	500ml	6
BF530521	1L	6

Anti-Rust Primer

- Excellent rust prevention
- Ideal product for factory maintenance
- Multiple applications around the home
- Very easy to apply
- For interior and exterior use
- Traditional red oxide colour
- Theoretical coverage 13m²/litre



Product No	Size	Pack
BF330022	250ml	6
BF330039	500ml	6
BF330046	1L	6

Red Oxide Metal Primer

- Used to protect ferrous metals against rust
- Resists rust
- Water resistant formulation
- Traditional red oxide colour
- For interior and exterior use
- Theoretical coverage 13m²/litre



Product No	Size	Pack
BF100120	250ml	6
BF100137	500ml	6
BF100144	1L	6
BF100151	2.5L	4
BF100168	5L	2

Problem Solving Primer

- Covers most stains including nicotine, water, adhesive residue, soot and wood tannins
- Suitable for internal and external use
- Can be tinted to pastel shades
- Virtually odour free
- Can be over-coated with most finishes, after only six hours
- Theoretical coverage 9m²/litre



Product No	Size	Pack
BF610032	500ml	6
BF610049	1L	6

Wood Primer

- Suitable for use on both soft and hard woods
- Interior and exterior use
- Contains vegetable oils which help feed the wood
- Theoretical coverage 13m²/litre



Product No	Colour	Size	Pack
BF050128	White	250ml	6
BF050135	White	500ml	6
BF050142	White	1L	6

Aluminium Wood Primer

- Suitable for resinous and bare hardwoods
- Prevents resin bleeding through fresh paintwork
- Interior and exterior use
- Contains vegetable oils which help feed the wood
- Theoretical coverage 13m²/litre



Product No	Colour	Size	Pack
BF050326	Aluminium	250ml	6
BF050333	Aluminium	500ml	6

High Performance Undercoat

- For internal and external use
- Excellent filling and obliteration properties
- Use on wood, metal, plaster and all normal surfaces
- Can be used under both gloss and semi-gloss finishes
- Two colour options
- Theoretical coverage 13m²/litre



Product No	Colour	Size	Pack
BF640121	White	250ml	6
BF640138	White	500ml	6
BF640145	White	1L	6
BF640220	Grey	250ml	6
BF640237	Grey	500ml	6
BF640244	Grey	1L	6

Acrylic Primer Undercoat

- 2 coats in 4 hours – that's fast
- All-in-one primer and undercoat
- Fast drying
- Interior and exterior use
- Two colour options
- Theoretical coverage 13m²/litre



Product No	Colour	Size	Pack
BF540124	White	250ml	6
BF540131	White	500ml	6
BF540148	White	1L	6
BF920124	Grey	250ml	6
BF920131	Grey	500ml	6
BF920148	Grey	1L	6

MDF Primer Undercoat

- All-in-one primer and undercoat for MDF
- Perfect for pre-decoration
- Suitable for interior and exterior use
- Theoretical coverage 13m²/litre



Product No	Size	Pack
BF670029	250ml	6
BF670036	500ml	6
BF670043	1L	6
BF670050	2.5L	4

Aluminium Paint

- Bright aluminium finish
- Heat resistant up to 150°C/300°F
- Reflects heat from surfaces
- Suitable for interior and exterior use
- Suitable for use on metal and wood
- Theoretical coverage 13m²/litre



Product No	Size	Pack
BF190121	250ml	6
BF190138	500ml	6
BF190145	1L	6

Satin Black Paint

- A rich satin finish
- For internal and external use
- Suitable for wood and metal
- Multiple uses
- Theoretical coverage 13m²/litre



Product No	Size	Pack
BF340311	125ml	6
BF340328	250ml	6
BF340335	500ml	6
BF340342	1L	6
BF340359	2.5L	4

Matt Black Paint

- Dead matt non-reflective finish
- Suitable for wood and metal
- Multiple uses
- Theoretical coverage 13m²/litre



Product No	Size	Pack
BF340212	125ml	6
BF340229	250ml	6
BF340236	500ml	6
BF340243	1L	6
BF340250	2.5L	4

Chalkboard Paint

- Matt finish
- Ideal for producing new and renovating old chalkboards
- Resists 'ghosting'
- Enables clear, legible chalk writing
- Theoretical coverage 13m²/litre



Product No	Size	Pack
BF340113	125ml	6
BF340120	250ml	6
BF340137	500ml	6
BF340144	1L	6
BF340151	2.5L	4

High-Heat Resistant Paint

- Withstands temperatures up to 600°C
- Matt black finish
- Ideal for use on barbecues, grates and radiators
- For internal and external use
- Theoretical coverage 13m²/litre



Product No	Size	Pack
BF069021	250ml	6
BF069038	500ml	6
BF069052	2.5L	4

Quick Drying Radiator Paint

- Non-yellowing
- Fast drying
- Tough and durable
- Brilliant white
- Heat resistant up to 100°C/200°F
- Theoretical coverage 13m²/litre



Product No	Size	Pack
BF730129	250ml	6
BF730136	500ml	6

Brick & Tile Paint

- Achieves an attractive matt tile red finish
- Quick drying
- Self cleaning
- Weather resistant
- Tough and durable
- Can be used on steps, roof tiles, bricks and masonry
- Theoretical coverage 13m²/litre



Product No	Size	Pack
BF560122	250ml	6
BF560139	500ml	6
BF560146	1L	6
BF560153	2.5L	4

Metallic Paint

- Bright metallic finish
- Interior and exterior use
- Fast drying
- Great for decorative and ornamental work
- Tough and durable
- Washable surface
- Theoretical coverage 14m²/litre



Product No	Colour	Size	Pack
BF620116	Gold	125ml	6
BF620123	Gold	250ml	6
BF620130	Gold	500ml	6
BF620178	Silver	125ml	6
BF620161	Silver	250ml	6
BF620208	Antique Gold	125ml	6
BF620192	Antique Gold	250ml	6
BF620185	Antique Gold	500ml	6

High Gloss Paint

- Long lasting finish
- Increased flexibility
- Tough and durable
- For use on most interior and exterior surfaces including wood, metal and plaster
- Theoretical coverage 13m²/litre



Product No	Colour	Size	Pack
BF630122	White	250ml	6
BF630139	White	500ml	6
BF630146	White	1L	6
BF630221	Black	250ml	6
BF630238	Black	500ml	6
BF630245	Black	1L	6

Quick Drying Metal Paint

- Heat resistant up to 150°C
- Tough and durable
- High gloss
- Choice of 8 popular colours
- Resists fuel, oils and grease
- Definitely a 'must stock' best seller
- Theoretical coverage 13m²/litre



Product No	Colour	Size	Pack
BF720120	White	250ml	6
BF720137	White	500ml	6
BF720144	White	1L	6
BF720151	White	2.5L	4
BF720229	Black	250ml	6
BF720236	Black	500ml	6
BF720243	Black	1L	6
BF720250	Black	2.5L	4
BF720335	Yellow	500ml	6
BF720342	Yellow	1L	6
BF720434	Red	500ml	6
BF720441	Red	1L	6
BF720632	Blue	500ml	6
BF720649	Blue	1L	6
BF720830	Silver	500ml	6
BF720939	Grey	500ml	6
BF720946	Grey	1L	6
BF721035	Landrover Green	500ml	6
BF721042	Landrover Green	1L	6

Anti-Slip Step Paint

- Improves grip underfoot
- Tough and durable
- Suitable for internal and external use
- Water resistant
- Resistant to oil, grease and dilute chemicals
- Theoretical coverage 13m²/litre



Product No	Colour	Size	Pack
BF830126	Tile Red	250ml	6
BF830133	Tile Red	500ml	6

Enamel Paint

- Ideal for small projects
- Small can size reduces wastage
- Hardwearing
- High gloss
- Multiple uses
- Suitable for interior and exterior use
- Theoretical coverage 13m²/litre



Product No	Colour	Size	Pack
BF390217	Black	125ml	6
BF390224	Black	250ml	6
BF390118	White	125ml	6
BF390125	White	250ml	6

Quick Drying Metal Paint Colour Chart

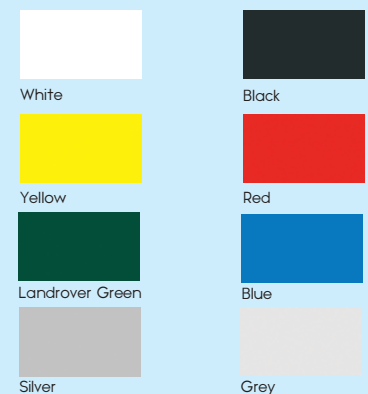

Polyurethane Varnish

- Suitable for all interior woodwork
- Brings out natural grain and colours in wood
- Resistant to heat, boiling water, dilute acids and alkalis, knocks and stains
- Tough and durable
- Matt, satin and gloss finish available
- Theoretical coverage 13m²/litre



SB

Coloured Gloss

Product No	Colour	Size	Pack
BF090124	Light Oak	250ml	6
BF090131	Light Oak	500ml	6
BF090223	Medium Oak	250ml	6
BF090230	Medium Oak	500ml	6
BF090322	Dark Oak	250ml	6
BF090339	Dark Oak	500ml	6
BF090421	Dark Mahogany	250ml	6
BF090438	Dark Mahogany	500ml	6
BF090520	Walnut	250ml	6
BF090537	Walnut	500ml	6
BF090827	Dark Jacobean	250ml	6
BF090834	Dark Jacobean	500ml	6
BF091022	Red Mahogany	250ml	6
BF091039	Red Mahogany	500ml	6
BF091428	Antique Pine	250ml	6
BF091435	Antique Pine	500ml	6

Clear

Product No	Finish	Size	Pack
BF070126	Gloss	250ml	6
BF070133	Gloss	500ml	6
BF070140	Gloss	1L	6
BF070157	Gloss	2.5L	4
BF070164	Gloss	5L	2
BF070225	Satin	250ml	6
BF070232	Satin	500ml	6
BF070249	Satin	1L	6
BF070256	Satin	2.5L	4
BF070263	Satin	5L	2
BF070324	Matt	250ml	6
BF070331	Matt	500ml	6
BF070348	Matt	1L	6
BF070355	Matt	2.5L	4

Polyurethane Varnish Colour Chart

Matt Finish Satin Finish



Clear Clear

Gloss Finish



Antique Pine Red Mahogany Light Oak

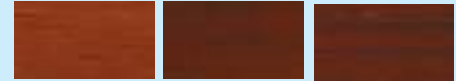

Medium Oak Dark Oak Dark Mahogany

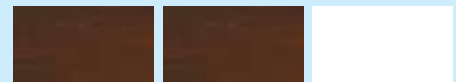

Walnut Dark Jacobean Clear

Quick Drying Varnish

- Ideal for all interior timber
- Low odour
- Touch dry in 60 minutes
- Resistant to heat, boiling water, knocks and dilute acids
- Matt, satin and gloss finish available
- Tough and durable
- Dries almost colourless
- Theoretical coverage 13m²/litre

Polyurethane Floor Varnish

- Flexible and durable
- Ideal for most floor surfaces – even stops dusting on concrete floors
- Seals against dirt
- Easy-to-clean surface
- Choice of gloss and satin finish
- Theoretical coverage 14m²/litre



SB

Product No	Finish	Size	Pack
BF930048	Gloss	1L	6
BF930055	Gloss	2.5L	4
BF930062	Gloss	5L	2
BF930147	Satin	1L	6
BF930154	Satin	2.5L	4
BF930161	Satin	5L	2

Quick Drying Floor Varnish

- Hardwearing slip-resistant finish
- Scratch resistant
- For interior floors
- Clear finish
- Quick drying
- Easy to clean
- Theoretic coverage 14m²/litre



WB

Product No	Finish	Size	Pack
BF120142	Gloss	1L	6
BF120159	Gloss	2.5L	4
BF120166	Gloss	5L	2
BF120241	Satin	1L	6
BF120258	Satin	2.5L	4
BF120265	Satin	5L	2



WB

Product No	Finish	Size	Pack
BF280228	Matt	250ml	6
BF280235	Matt	500ml	6
BF280242	Matt	1L	6
BF280259	Matt	2.5L	4
BF280129	Satin	250ml	6
BF280136	Satin	500ml	6
BF280143	Satin	1L	6
BF280150	Satin	2.5L	4
BF740128	Gloss	250ml	6
BF740135	Gloss	500ml	6
BF740142	Gloss	1L	6
BF740159	Gloss	2.5L	4

Wood Dye

- Quick drying
- Use on new or stripped wood
- Very extensive colour and size range
- Can be used on internal and external wood
- Formulated with translucent pigments meaning that more than one coat can be applied if required
- Shades can be mixed together to produce a custom shade
- Easy-to-apply by cloth or brush
- Theoretical coverage 13m²/litre



Product No	Colour	Size	Pack
BF250122	Light Oak	250ml	6
BF250139	Light Oak	500ml	6
BF250221	Medium Oak	250ml	6
BF250238	Medium Oak	500ml	6
BF250320	Dark Oak	250ml	6
BF250337	Dark Oak	500ml	6
BF251228	Antique Pine	250ml	6
BF251235	Antique Pine	500ml	6
BF251327	Rosewood	250ml	6
BF251334	Rosewood	500ml	6
BF251624	Redwood	250ml	6
BF251631	Redwood	500ml	6
BF250627	Teak	250ml	6
BF250634	Teak	500ml	6
BF250726	Dark Jacobean	250ml	6
BF250733	Dark Jacobean	500ml	6
BF251525	Chestnut	250ml	6
BF251532	Chestnut	500ml	6

Wood Dye Colour Chart

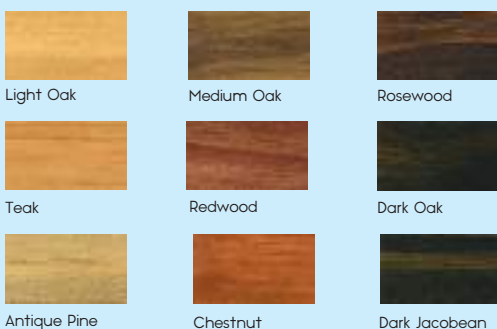

Patent Knotting

- Overcomes problems associated with painting knotty or resinous wood
- Made from pure shellac and methylated spirit
- Seals the surface
- Prevents seepage of the resins in the timber
- Ideal for use on new or stripped wood prior to priming



Product No	Size	Pack
BF310191	250ml	6
BF320139	500ml	6

Danish Oil

- 'Easy to apply' wood oil
- Can be used internally and externally
- Provides a low lustre satin finish
- Scratchproof
- Ideal for most timber surfaces



Product No	Size	Pack
BF770125	250ml	6
BF770132	500ml	6
BF770149	1L	6
BF770156	2.5L	4
BF770163	5L	2

Boiled Linseed Oil

- Penetrates deep into the surface of the wood
- Provides an attractive ruby tint
- Can be used internally or externally
- Ideal for all bare timber, both hard and soft, except Oak
- Also useful for softening metal glazing putty



Product No	Size	Pack
BF892025	250ml	6

Raw Linseed Oil

- Penetrates deep into the surface, nourishing and protecting all types of wood
- Lubricant for French Polish
- Also used for softening putty



Product No	Size	Pack
BF891028	250ml	6

Exterior Woodstain

- Micro-porous – allows the wood to breathe
- Stains, protects and finishes
- Made with light-fast colours – resists fading
- Will not flake, crack or peel
- Satin finish
- Weather resistant and water repellent
- Suitable for both hardwood and softwood
- Theoretical coverage 13m²/litre



Product No	Colour	Size	Pack
BF510127	Golden Teak	250ml	6
BF510134	Golden Teak	500ml	6
BF510141	Golden Teak	1L	6
BF510158	Golden Teak	2.5L	4
BF510226	Nut Brown	250ml	6
BF510233	Nut Brown	500ml	6
BF510240	Nut Brown	1L	6
BF510257	Nut Brown	2.5L	4
BF510325	Red Mahogany	250ml	6
BF510349	Red Mahogany	1L	6
BF510356	Red Mahogany	2.5L	4
BF510523	Chestnut	250ml	6
BF510547	Chestnut	1L	6
BF510554	Chestnut	2.5L	4
BF510820	Brown Mahogany	250ml	6
BF510537	Brown Mahogany	500ml	6
BF510844	Brown Mahogany	1L	6
BF510851	Brown Mahogany	2.5L	4
BF510622	Clear	250ml	6
BF510639	Clear	500ml	6
BF510646	Clear	1L	6
BF510653	Clear	2.5L	4

Exterior Varnish

- Suitable for all wood and exterior joinery
- Tough and durable
- Protects against all weather conditions
- Flexible
- Theoretical coverage 13m²/litre



Product No	Finish	Size	Pack
BF430128	Gloss	250ml	6
BF430135	Gloss	500ml	6
BF430142	Gloss	1L	6
BF430159	Gloss	2.5L	4
BF430227	Satin	250ml	6
BF430234	Satin	500ml	6
BF430241	Satin	1L	6
BF430258	Satin	2.5L	4

Super Yacht Varnish

- For all exterior wood and joinery
- Protects timber in extreme environments
- Resists all climatic conditions
- High gloss finish
- Tough and durable
- Ideal for wooden yachts and boats
- Theoretical coverage 13m²/litre



Product No	Size	Pack
BF270120	250ml	6
BF270137	500ml	6
BF270144	1L	6
BF270151	2.5L	4

Anti-Slip Deck Coating

- Clear, slip resistant finish
- Contains micro-aggregate
- Ideal for timber decking and walkways
- With UV protection
- Theoretical coverage 9m²/litre



Product No	Size	Pack
BF115056	2.5L	4

Teak Oil

- Nourishes and protects wood
- Reduces surface splitting
- Reduces greying
- Reduces the effects of weathering



Product No	Size	Pack
BF500128	250ml	6
BF500135	500ml	6
BF500142	1L	6
BF500159	2.5L	4

Exterior Woodstain Colour Chart

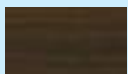

Nut Brown

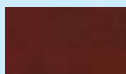

Red Mahogany



Chestnut



Golden Teak



Brown Mahogany



Clear

Paint & Varnish Remover

- Fast acting formulation
- Non-drip consistency
- Self neutralising, no washing down required
- Effective on a wide range of finishes
- Will not discolour or raise the grain on timber



Product No	Size	Pack
BF160124	250ml	6
BF160131	500ml	6
BF160148	1L	6
BF160155	2.5L	4
BF160162	5L	2

Acid Etch

- Etches power floated, very smooth, hard or chemically treated concrete floors to key the surface and improve the adhesion of floor coatings
- Removes excess lime dust (laitence) which can interfere with the adhesion of floor coatings



Product No	Size	Pack
BF360180	5L	2

Solvent Based Floor Sealer

- Binds, seals and stabilises friable surfaces
- A clear, alkyd sealer for porous surfaces
- Designed for use on bare concrete
- For indoor use only
- Theoretical coverage 10-15m²/litre/coat depending on surface porosity



Product No	Size	Pack
BF360265	5L	2

Water Based Floor Sealer

- Penetrates, binds, and seals porous surfaces
- Particularly for use under water based floor finishes
- Can be used as a dust proofer
- Also suitable for brick and masonry surfaces
- Clear finish
- Use with Acrylic Floor Paint
- Theoretical coverage 10-15m²/litre/coat depending on surface porosity



Product No	Size	Pack
BF360197	5L	2

Polyurethane Floor Paint

- Specially formulated to resist oil and grease
- Hardwearing gloss finish
- Can be applied to previously painted surfaces
- Suitable for internal and external use
- Ideal for foot and light traffic areas
- Theoretical coverage 12-14m²/litre/coat
- Also available tinted to any RAL, NCS or BS4800 colour



Product No	Colour	Size	Pack
BF360906	White	500ml	6
BF360890	White	1L	6
BF360883	White	2.5L	4
BF360876	White	5L	2
BF360548	Light Grey	500ml	6
BF360531	Light Grey	1L	6
BF360524	Light Grey	2.5L	4
BF360517	Light Grey	5L	2
BF360586	Mid Grey	500ml	6
BF360579	Mid Grey	1L	6
BF360562	Mid Grey	2.5L	4
BF360555	Mid Grey	5L	2
BF360623	Dark Grey	500ml	6
BF360616	Dark Grey	1L	6
BF360609	Dark Grey	2.5L	4
BF360593	Dark Grey	5L	2
BF360869	Black	500ml	6
BF360852	Black	1L	6
BF360845	Black	2.5L	4
BF360838	Black	5L	2
BF360456	Tile Red	500ml	6
BF360449	Tile Red	1L	6
BF360432	Tile Red	2.5L	4
BF360425	Tile Red	5L	2

Acrylic Floor Paint

- Semi-gloss finish
- Low odour – ideal for areas where paint odours present an issue
- Ideal for light traffic areas
- Four colour options
- Suitable for previously painted sound surfaces
- Can be used both indoors and outdoors
- Fast drying
- Theoretical coverage 11m²/litre/coat
- Also available tinted to any RAL, NCS or BS4800 colour

Product No	Colour	Size	Pack
BF361163	White	1L	6
BF361156	White	2.5L	4
BF360210	White	5L	2
BF361224	Mid Grey	1L	6
BF361217	Mid Grey	2.5L	4
BF360241	Mid Grey	5L	2
BF361187	Black	1L	6
BF361170	Black	2.5L	4
BF360227	Black	5L	2
BF361231	Tile Red	2.5L	4
BF360258	Tile Red	5L	2



Acrylic Floor Paint, Polyurethane Floor Paint and High Traffic Floor Paint are available tinted to any RAL, NCS or BS4800 colour. Contact us for details and pricing.

High Traffic Floor Paint

- Exceptionally hard wearing
- Designed for high traffic environments
- Internal and external use
- Minimises disruption due to rapid drying time
- Vehicular traffic can use after 3 days
- Can be applied over concrete, metal, brickwork and stone
- Resists oil, grease and solutions of acid and alkali
- Semi-gloss finish
- Theoretical coverage 12m²/litre/coat



Product No	Colour	Size	Pack
BF361521	Grey	5L	2
BF361538	Tile Red	5L	2

Anti-Slip Floor Paint

- A tough, durable, high opacity floor coating
- Aggregated finish for total slip resistance
- Formulated for foot and light traffic areas
- Semi-gloss finish
- Suitable for indoor and outdoor use
- Choice of 7 colours
- Theoretical coverage 8m²/litre/coat

Product No	Colour	Size	Pack
BF361149	White	1L	6
BF361132	White	2.5L	4
BF361125	White	5L	2
BF361026	Light Grey	1L	6
BF361019	Light Grey	2.5L	4
BF361002	Light Grey	5L	2
BF361057	Mid Grey	1L	6
BF361040	Mid Grey	2.5L	4
BF361033	Mid Grey	5L	2
BF361118	Black	1L	6
BF361101	Black	2.5L	4
BF361095	Black	5L	2
BF360968	Tile Red	1L	6
BF360951	Tile Red	2.5L	4
BF360944	Tile Red	5L	2
BF360999	Green	1L	6
BF360982	Green	2.5L	4
BF360975	Green	5L	2
BF361071	Yellow	2.5L	4



Line Marking Paint

- Ideal for factories, schools, car parks and public areas
- Quick drying
- Excellent resistance to abrasion and harsh cleaning products
- Matt finish
- Available in 2 colours
- Suitable for indoor and outdoor use
- Theoretical coverage 13m²/litre/coat



Product No	Colour	Size	Pack
BF240147	White	1L	6
BF450140	Yellow	1L	6
BF450157	Yellow	2.5L	4
BF450164	Yellow	5L	2

Anti-Climb Paint

- Achieves a slippery, non-drying coating
- Can be applied to brickwork, concrete, plastic, metal and wood
- Semi-matt finish
- Theoretical coverage 2m²/litre



Product No	Colour	Size	Pack
BF360272	Black	1L	6
BF360289	Black	2.5L	4
BF360296	Black	5L	2

Intulac Ultra Intumescent Varnish

- High performance, fire protection varnish system for interior wood
- Tested over previously varnished timber
- Tested to BS476: Parts 6 & 7, providing Class 0 protection
- Supplied in 2 parts: base coat and topcoat
- Highlights the natural beauty of wood
- Theoretical coverage 2.5m²/litre



Product No	Type	Size	Pack
BL631004	Base Coat	5L	1
BL632025	Satin Top Coat	500ml	1
BL632018	Matt Top Coat	500ml	1

Bitcote Black Bitumen Paint

- Anti-corrosive coating
- Ideal for application to many different materials such as steel and iron fabrications, timber, concrete and brickwork
- Extensively used by the agricultural industry for protecting fences and barns
- Theoretical coverage 11m²/litre



Product No	Size	Pack
PABB001	1L	6
PABB005	5L	4

Paragon Polyurethane Floor Paint

an essential
for every
paint
store



...see page 108 for details

Fire Retardant Treatment



Never before has there been such a simple product to use for the protection of timber against fire

- Achieves European Class B-s2,d0 (equivalent to Class 0 & 1)
- Tested to European Standard BS EN 13501-1
- Suitable for timber in both internal and external environments
- Moisture resistant
- Unaffected by wear
- Simple specification
- Leaves timber looking natural
- Waterborne
- Non-specialist application
- Suitable for off-site application
- Application by brush, roller or spray
- Colourless and odourless
- Non-leaching
- Unaffected by humidity
- Simple online certificate application
- Coverage rate 4m²/litre

Product No	Size	Pack
ZFP400168	5L	1
ZFP404647	20L	1

5L is sufficient to treat 20m² (excluding wastage)

Fire Retardant Paint



Achieves Class 0 on internal surfaces

Zeroflame Paint is one of the most versatile fire protection coatings available on the market.

It will achieve Class 0 on timber surfaces and maintain Class 0 on non-combustible surfaces such as plaster walls. It can also be applied over sound existing coatings and where a final decorative or protective finish is required, a water borne, non-flammable paint may be used. Added to all this it is a single-pack, waterborne product which is extremely simple to use.

- Achieves European Class B-s2,d0 (equivalent to Class 0 & 1)
- Tested to European Standard EN13501-1
- Application by brush, roller or spray
- Can be applied over sound existing coatings
- Matt white finish
- Where a final decorative or protective finish is required, a water borne, non-flammable paint may be used
- Single pack system
- Simple online certificate application
- Coverage rate 3.7m²/litre

Product No	Size	Pack
ZFP400007	5L	2

5L is sufficient to cover 18.5m² (excluding wastage)

For further information on our products please scan the QR codes below:



Fire Retardant Treatment



Fire Retardant Paint



AquaSteel WB+

Visit zeroflame.co to calculate the exact amount of product required for any job

Fire Resistant AquaSteel WB+

Achieves both 1/2 hour and 1 hour fire resistance on structural steel

- Suitable for use on all standard steel sizes and profiles
- Fire tested to BS476: Part 21:1987. Suitable for C1 and C2 environments
- Waterborne
- Can be applied by brush, roller or airless spray
- Simple specification
- Simple online certificate application
- Matt white finish

ZeroFlame continue to make things simpler. Usually calculating the required material to achieve fire protection for structural steel involves the complicated and time consuming process of getting details of all the steel members involved in the project and calculating the exact amount of material required for each one.

Now things have been made even simpler. AquaSteel WB+ Intumescent Coating combines the ability to protect all standard steel sizes and profiles for both 1/2 hour and 1 hour fire resistance in a single product.

Product No	Size	Pack
ZFP406474	2.5L	4
ZFP406481	5L	2
ZFP406498	10L	1



AquaSteel WB+ Coverage Rates								
Structural Steel	Horizontal Beams		Vertical Columns		Hollow Sections			
					Square & Rectangular		Circular	
No of sides	m ² / litre	m ² / container	m ² / litre	m ² / container	m ² / litre	m ² / container	m ² / litre	m ² / container
1/2 HOUR FIRE RESISTANCE								
4 sides	2.3	23.0 / 10 litres	2.3	23.0 / 10 litres	1.9	19.0 / 10 litres	1.9	19.0 / 10 litres
		11.5 / 5 litres		11.5 / 5 litres		9.5 / 5 litres		9.5 / 5 litres
		5.7 / 2.5 litres		5.7 / 2.5 litres		4.7 / 2.5 litres		4.7 / 2.5 litres
1 HOUR FIRE RESISTANCE								
4 sides	1.1	11.0 / 10 litres	1.1	11.0 / 10 litres	0.55	5.5 / 10 litres	0.55	5.5 / 10 litres
		5.5 / 5 litres		5.5 / 5 litres		2.7 / 5 litres		2.7 / 5 litres
		2.7 / 2.5 litres		2.7 / 2.5 litres		1.3 / 2.5 litres		1.3 / 2.5 litres
3 Sides Coverage Rates								
3 sides	1/2 HOUR FIRE RESISTANCE				1 HOUR FIRE RESISTANCE			
	3.0	30.0 / 10 litres	2.3	23.0 / 10 litres	1.4	14.0 / 10 litres	1.1	11.0 / 10 litres
15.0 / 5 litres		11.5 / 5 litres		7.0 / 5 litres		5.5 / 5 litres		
7.5 / 2.5 litres		5.7 / 2.5 litres		3.5 / 2.5 litres		2.7 / 2.5 litres		

AquaSteel WB+ Finish

- Protective finish for AquaSteel WB+
- Available to order in any RAL or BS colour
- Theoretical coverage 12m²/litre

Product No	Finish	Size	Pack
Various	Gloss	2.5L	1
Various	Eggshell	2.5L	1



zeroflame.co

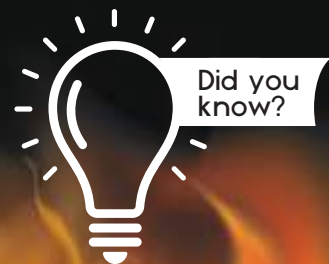

ZeroFlame is a **relay** brand



Basic

- The all-rounder of spray paints
- Especially recommended for painting wood, metal, fabric, stone, fiberglass and rigid plastics
- Enamel with high adhesion and resistance both internally and externally
- Adheres very well to any surface and offers a lot of flexibility
- Very economical
- Ideal for all DIY projects
- Thermal resistance 90°C
- 400ml can covers 2m². Dries in 4 hours. Overcoat in 1 hour



Product No	Colour	Colour Code	Finish	Size	Pack
PP256406	Sand Yellow	1002	Gloss	400ml	6
PP256604	Ochre	B129	Gloss	400ml	6
PP256208	Light Ivory	1015	Gloss	400ml	6
PP255805	Light Yellow	B190	Gloss	400ml	6
PP214000	Citric Yellow	B148	Gloss	400ml	6
PP112603	Traffic Yellow	1023	Gloss	400ml	6
PP113006	Melon Yellow	1028	Gloss	400ml	6
PP112405	Traffic Orange	2009	Gloss	400ml	6
PP113204	Ruby Red	3003	Gloss	400ml	6
PP165807	Wine Red	3005	Gloss	400ml	6
PP257205	Pink	B112	Gloss	400ml	6
PP254402	Cherry Red	B184	Gloss	400ml	6
PP110807	Traffic Red	3020	Gloss	400ml	6
PP254600	Light Red	B164	Gloss	400ml	6
PP257007	Salmon Pink	3022	Gloss	400ml	6
PP112801	Heather Violet	4003	Gloss	400ml	6
PP255607	Purple	B127	Gloss	400ml	6
PP113600	Light Violet	B126	Gloss	400ml	6
PP111804	Violet	B125	Gloss	400ml	6
PP113402	Sapphire Blue	5003	Gloss	400ml	6
PP111408	Light Blue	B119	Gloss	400ml	6
PP111606	Traffic Blue	5017	Gloss	400ml	6
PP255003	Turquoise Blue	5018	Gloss	400ml	6
PP111200	Sky Blue	B121	Gloss	400ml	6
PP254808	Lake Blue	B187	Gloss	400ml	6
PP255201	Carriage Green	B186	Gloss	400ml	6
PP166002	Reseda Green	6011	Gloss	400ml	6
PP255409	Lime Green	B188	Gloss	400ml	6
PP112009	Yellow Green	6018	Gloss	400ml	6
PP112207	Mint Green	6029	Gloss	400ml	6
PP256000	Squirrel Grey	7000	Gloss	400ml	6
PP166408	Iron Grey	7011	Gloss	400ml	6
PP111002	Agate Grey	7038	Gloss	400ml	6
PP256802	Red Brown	8012	Gloss	400ml	6
PP110401	Black	9005	Gloss	400ml	6
PP110005	White	9010	Gloss	400ml	6
PP166200	Fawn Brown	8007	Gloss	400ml	6
PP259803	Traffic Yellow	1023	Matt	400ml	6
PP258806	Traffic Red	3020	Matt	400ml	6
PP259605	Traffic Blue	5017	Matt	400ml	6
PP259209	Mint Green	6029	Matt	400ml	6
PP259001	Squirrel Grey	7000	Matt	400ml	6
PP259407	Fawn Brown	8007	Matt	400ml	6
PP110609	Black	9005	Matt	400ml	6
PP110203	White	9010	Matt	400ml	6
PP166804	Black	9005	Satin	400ml	6
PP166606	White	9010	Satin	400ml	6
PP114003	Clear Varnish	B199	Gloss	400ml	6
PP236408	Clear Varnish	M199	Matt	400ml	6
PP257403	Clear Varnish	S199	Satin	400ml	6

Gloss Finish



Satin Finish



Matt Finish



Basic Fluorescent

- Achieves fluorescence on a multitude of materials (wood, metal, cardboard, paper, glass, rigid plastics, etc)
- Suitable for interior and exterior use
- Thermal resistance 90°C
- 400ml can covers 1m². Dries in 15 minutes. Overcoat in 15 minutes



Product No	Colour	Size	Pack
PP237009	Yellow	400ml	6
PP236804	Orange	400ml	6
PP117806	Fuchsia	400ml	6
PP236606	Red	400ml	6
PP237405	Blue	400ml	6
PP237207	Green	400ml	6

Basic Metallic

- Suitable for painting metal, wood, stone, cardboard, rigid plastics and all kinds of objects where a metallic effect is desired
- Ideal for painting decoration pieces
- Internal use only
- Thermal resistance 90°C
- 400ml can covers 1.2m². Dries in 10 minutes. Overcoat in 5 minutes



Product No	Colour	Size	Pack
PP114805	Silver	400ml	6
PP115000	Gold	400ml	6
PP115208	Copper	400ml	6

Evolution Fluorescent

- Fluorescent acrylic paint in a matt finish
- Suitable for interior and exterior use
- Suitable for use on any type of material: metal, wood, cardboard, paper, glass and most plastic materials
- In order to obtain an optimal fluorescent effect, use on surfaces previously painted with Pinty Plus Evolution White, applying two thin layers and letting them dry prior to using the chosen colour
- 400ml can covers 1m². Dries in 15 minutes. Overcoat in 15 minutes



Product No	Colour	Finish	Size	Pack
PP117004	Orange	Matt	400ml	6
PP117202	Yellow	Matt	400ml	6
PP117608	Green	Matt	400ml	6
PP118001	Blue	Matt	400ml	6
PP118209	Red	Matt	400ml	6

Evolution Metallic

- Metallic effect acrylic paint in a gloss finish
- Quick drying
- Suitable for interior and exterior use
- Ideal for the restoration, maintenance and decoration of bicycles, skateboards, helmets etc.
- Suitable for use on surfaces such as wood, metal, cardboard, stone and most plastic surfaces
- 400ml can covers 1.4m². Dries in 15 minutes. Overcoat in 5 minutes



Product No	Colour	Finish	Size	Pack
PP193602	Gold	Gloss	400ml	6
PP194203	Silver	Gloss	400ml	6

Evolution

- Extra-quick drying RAL acrylic paint
- Suitable for interior and exterior use
- Provides excellent protection and smooth uniform finish
- Adheres perfectly on any type of surface: wood, metal, stone, paper, cardboard and some plastics
- Ideal for painting surfaces that require rapid drying for their operation
- RAL standard colours
- Suitable for coding of pipes, retouching or painting supports in industrial environments, useful in household and automobile etc.
- 400ml can covers 2m². Dries in 15 minutes. Overcoat in 5 minutes



Product No	Colour	RAL	Finish	Size	Pack
PP223804	Beige	1001	Gloss	400ml	6
PP169805	Daffodil Yellow	1007	Gloss	400ml	6
PP170009	Ivory	1014	Gloss	400ml	6
PP188400	Light Ivory	1015	Gloss	400ml	6
PP240405	Zinc Yellow	1018	Gloss	400ml	6
PP170207	Sunny Yellow	1021	Gloss	400ml	6
PP183009	Melon Yellow	1028	Gloss	400ml	6
PP240603	Vermilion	2002	Gloss	400ml	6
PP240801	Pastel Orange	2003	Gloss	400ml	6
PP170405	Pure Orange	2004	Gloss	400ml	6
PP170603	Flame Red	3000	Gloss	400ml	6
PP241006	Signal Red	3001	Gloss	400ml	6
PP207804	Ruby Red	3003	Gloss	400ml	6
PP183207	Wine Red	3005	Gloss	400ml	6
PP225600	Antique Pink	3014	Gloss	400ml	6
PP170801	Traffic Red	3020	Gloss	400ml	6
PP171006	Red Lilac	4001	Gloss	400ml	6
PP225402	Traffic Purple	4006	Gloss	400ml	6
PP224603	Telemagenta	4010	Gloss	400ml	6
PP241204	Ultramarine Blue	5002	Gloss	400ml	6
PP171204	Sapphire Blue	5003	Gloss	400ml	6
PP223200	Signal Blue	5005	Gloss	400ml	6
PP183405	Gentian Blue	5010	Gloss	400ml	6
PP171402	Sky Blue	5015	Gloss	400ml	6
PP208009	Traffic Blue	5017	Gloss	400ml	6
PP223408	Water Blue	5021	Gloss	400ml	6
PP223606	Distant Blue	5023	Gloss	400ml	6
PP241402	Emerald Green	6001	Gloss	400ml	6
PP171600	Moss Green	6005	Gloss	400ml	6
PP183801	Fir Green	6009	Gloss	400ml	6
PP225808	Grass Green	6010	Gloss	400ml	6
PP171808	Reseda Green	6011	Gloss	400ml	6
PP241600	May Green	6017	Gloss	400ml	6
PP172003	Yellow Green	6018	Gloss	400ml	6
PP183603	Mint Green	6029	Gloss	400ml	6
PP226003	Mint Turquoise	6033	Gloss	400ml	6
PP172201	Silver Grey	7001	Gloss	400ml	6
PP208207	Iron Grey	7011	Gloss	400ml	6
PP224207	Anthracite Grey	7016	Gloss	400ml	6
PP224405	Stone Grey	7030	Gloss	400ml	6
PP172409	Light Grey	7035	Gloss	400ml	6
PP184006	Traffic Grey	7042	Gloss	400ml	6
PP172607	Ochre Brown	8001	Gloss	400ml	6
PP172805	Nut Brown	8011	Gloss	400ml	6
PP224801	Chocolate Brown	8017	Gloss	400ml	6
PP225006	Grey Brown	8019	Gloss	400ml	6
PP225204	Pale Brown	8025	Gloss	400ml	6
PP224009	Signal White	9003	Gloss	400ml	6
PP173000	Signal Black	9004	Gloss	400ml	6
PP182200	Jet Black	9005	Gloss	400ml	6
PP184402	White Aluminium	9006	Gloss	400ml	6
PP184808	Pure White	9010	Gloss	400ml	6
PP173208	Traffic White	9016	Gloss	400ml	6
PP206807	Silver			400ml	6
PP207002	Gold			400ml	6
PP242805	Copper			400ml	6
PP184600	White	9010	Matt	400ml	6
PP184204	Black	9005	Matt	400ml	6
PP213201	White	9010	Satin	400ml	6
PP200003	Black	9005	Satin	400ml	6

Product No	Colour	RAL	Finish	Size	Pack
PP264401	Rose Gold			400ml	6
PP265200	Signal Yellow	1003	Gloss	400ml	6
PP265408	Traffic Yellow	1023	Gloss	400ml	6
PP264609	Bright Red Orange	2008	Gloss	400ml	6
PP265606	Carmine Red	3002	Gloss	400ml	6
PP265804	Oxide Red	3009	Gloss	400ml	6
PP266009	Light Blue	5012	Gloss	400ml	6
PP266207	Pastel Blue	5024	Gloss	400ml	6
PP266405	Leaf Green	6002	Gloss	400ml	6
PP211207	Black Grey	7021	Gloss	400ml	6
PP266603	Graphite Grey	7024	Gloss	400ml	6
PP266801	Pebble Grey	7032	Gloss	400ml	6
PP267006	Red Brown	8012	Gloss	400ml	6

Evolution Water Based

- Quick drying RAL alkyd enamel spray paint
- Specially designed for users looking for a more environmentally friendly spray paint
- No smell as it does not contain aggressive solvents
- The formulation allows a smooth and uniform finish to be achieved
- Excellent adhesion
- Great flexibility once dry
- Suitable for external use
- Suitable for painting most materials, including delicate surfaces
- The range includes a primer and two varnishes
- Thermal resistance 90°C
- 400ml can covers 2m²
- Dust-drying in 15 min. Dry to the touch in 1 hour. Complete drying in 4 hours. Overcoat in 15 minutes



Product No	Colour	RAL	Finish	Size	Pack
PP288209	Ivory	1014	Gloss	400ml	6
PP272802	Light Ivory	1015	Gloss	400ml	6
PP273007	Sunny Yellow	1021	Gloss	400ml	6
PP273205	Melon Yellow	1028	Gloss	400ml	6
PP273403	Pure Orange	2004	Gloss	400ml	6
PP273601	Flame Red	3000	Gloss	400ml	6
PP288605	Signal Red	3001	Gloss	400ml	6
PP273809	Traffic Red	3020	Gloss	400ml	6
PP289206	Red Lilac	4001	Gloss	400ml	6
PP288803	Telemagenta	4010	Gloss	400ml	6
PP288001	Ultramarine Blue	5002	Gloss	400ml	6
PP287806	Sapphire Blue	5003	Gloss	400ml	6
PP274004	Gentian Blue	5010	Gloss	400ml	6
PP274202	Sky Blue	5015	Gloss	400ml	6
PP274400	Traffic Blue	5017	Gloss	400ml	6
PP289008	Leaf Green	6002	Gloss	400ml	6
PP274608	Moss Green	6005	Gloss	400ml	6
PP287608	Fir Green	6009	Gloss	400ml	6
PP274806	Yellow Green	6018	Gloss	400ml	6
PP275001	Mint Green	6029	Gloss	400ml	6
PP275209	Silver Grey	7001	Gloss	400ml	6
PP287400	Iron Grey	7011	Gloss	400ml	6
PP275407	Basalt Grey	7012	Gloss	400ml	6
PP275605	Anthracite Grey	7016	Gloss	400ml	6
PP275803	Light Grey	7035	Gloss	400ml	6
PP276008	Nut Brown	8011	Gloss	400ml	6
PP276206	Chocolate Brown	8017	Gloss	400ml	6
PP288407	Grey Brown	8019	Gloss	400ml	6
PP276404	Jet Black	9005	Gloss	400ml	6
PP276602	White Aluminium	9006	Gloss	400ml	6
PP276800	Pure White	9010	Gloss	400ml	6
PP277005	Traffic White	9016	Gloss	400ml	6
PP281200	Traffic Black	9017	Gloss	400ml	6
PP289602	Traffic Yellow	1023	Matt	400ml	6
PP290004	Ruby Red	3003	Matt	400ml	6
PP289800	Signal Blue	5005	Matt	400ml	6
PP289404	Emerald Green	6001	Matt	400ml	6
PP272406	Jet Black	9005	Matt	400ml	6
PP272604	Pure White	9010	Matt	400ml	6
PP291001	Silver		Metallic	400ml	6
PP290806	Gold		Metallic	400ml	6
PP291209	Copper		Metallic	400ml	6
PP281408	White Primer		Matt	400ml	6
PP277203	Varnish		Gloss	400ml	6
PP272208	Varnish		Matt	400ml	6

Gloss Finish



Matt Finish



Metallic Paint



Chrome Effect

- Quick-drying decorative paint
- For use on metal, paper, wicker, ceramics and most plastic materials
- Avoid handling the painted object
- 400ml can covers 2m². Dries in 30 minutes. Overcoat in 1 hour



Product No	Colour	Size	Pack
PP122206	Silver	400ml	6
PP122404	Gold	400ml	6

Mirror Effect

- Achieves a mirror effect on glass, crystal, methacrylate or similar surfaces
- For creative and decorative purposes
- It must be applied to the inside of the surface to achieve the mirror effect on the outside
- It will also achieve an extremely shiny silver effect on opaque surfaces
- It is advisable to apply this paint on very smooth surfaces
- 400ml can covers 2m². Dries in 5 minutes. Overcoat in 2 minutes (each coat)

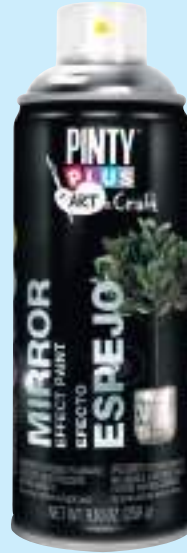

Product No	Size	Pack
PP281606	400ml	6

Magnetic Paint

- Provides an easy and simple way to turn objects into magnet holders
- Designed to hold light and flat magnets
- This paint contains metallic elements so that the magnets adhere to it
- 400ml can covers 1.5m². Dries in 30 minutes. Overcoat in 5 minutes. Repaint with another paint after 5 days



Product No	Size	Pack
PP260007	400ml	6

Blackboard Paint

- Creates a blackboard on any surface, flat or shaped
- High performance, coverage and elasticity
- Suitable for wood, metal, cardboard, stone, fiberglass, rigid plastic, etc.
- To achieve a perfect finish, treat the surface with a primer before applying the Blackboard Paint
- Can be washed with soap and water once dry
- 400ml can covers 2m². Dries in 2 hours. Overcoat in 1 hour

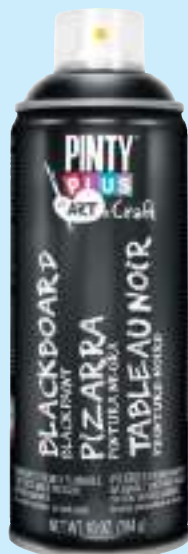

Product No	Size	Pack
PP238204	400ml	6

Clear Varnish

- Protects, enhances and waterproofs
- Low odour, which is ideal for using indoors on craft projects
- Fast drying and non-yellowing
- Non-toxic
- Gloss, Satin or Matt finishes available
- Ideal for use on plaster, marble, wood, resin, wicker, cork, ceramic, stone, cardboard, papier maché, expanded polystyrene, etc
- 400ml can covers 1.4m². Dries in 1 hour



Product No	Type	Colour	Size	Pack
PP221008	Water Based	Gloss	400ml	6
PP221404	Water Based	Satin	400ml	6
PP221206	Water Based	Matt	400ml	6
PP161403	Solvent Based	Gloss	400ml	6
PP161809	Solvent Based	Satin	400ml	6
PP161601	Solvent Based	Matt	400ml	6

White Household Appliances

- Quick drying white gloss finish paint is ideal for completely respraying or touching up damaged household appliances
- Ideal for fridges, freezers, washing machines, ovens etc.
- 400ml can covers 2m². Dries in 15 minutes. Overcoat in 5 minutes



Product No	Colour	Finish	Size	Pack
PP115604	White	Gloss	400ml	6

Inox Household Appliances

- Ideal for modernising and rejuvenating the appearance of household appliances
- Ideal for fridges, freezers, washing machines, ovens etc.
- 400ml can covers 2m². Dries in 30 minutes. Overcoat in 30 minutes



Product No	Colour	Size	Pack
PP212600	Stainless Steel	400ml	6

Radiator White

- Coat and preserve radiators with this quick-drying, white, gloss, acrylic enamel for a durable, fresh-looking finish
- Withstands temperatures up to 90°C
- Ideal for painting and retouching cast radiators, aluminium radiators, heating tubes, heaters etc.
- 400ml can covers 2m². Dries in 15 minutes. Overcoat in 5 minutes



Product No	Colour	Finish	Size	Pack
PP212808	White	Gloss	400ml	6

High Temperature Paint

- Specifically designed for use on products and surfaces that are exposed to high temperatures
- Can withstand temperatures of up to 600°C
- Ideal for use on exhaust pipes, heaters, radiators etc.
- 400ml can covers 2m². Dries in 30 minutes. Overcoat in 30 minutes

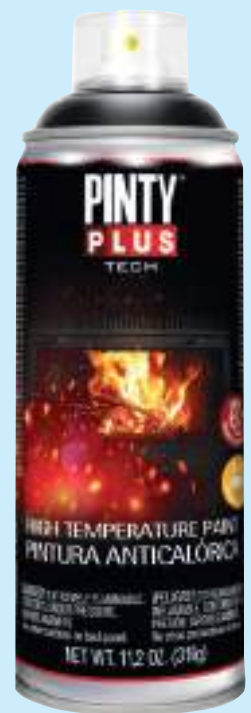

Product No	Colour	Size	Pack
PP119602	Silver	400ml	6
PP120202	Matt Black	400ml	6

Forge Paint

- A matt epoxy paint designed for the decoration and protection of metallic surfaces
- It provides a thick, tough finish which produces an 'antique iron' effect
- Quick drying formulation with very good adherence on metallic materials
- Two-in-one primer and coating offering resistance to abrasion and excellent durability in outdoor conditions
- Ideal for use on railings, post boxes, exterior lights, iron gates, etc.
- 400ml can covers 1m². Dries in 15 minutes. Overcoat in 30 minutes



Product No	Colour	Finish	Size	Pack
PP158809	Black	Matt	400ml	6
PP159004	Grey	Matt	400ml	6
PP237801	Red	Matt	400ml	6
PP238006	Blue	Matt	400ml	6
PP162004	Green	Matt	400ml	6

Ferric Primer

- Creates a protective coating on iron objects for repelling moisture in damp conditions, thus prolonging the life of the object and providing a more appealing surface
- Ideal for use on iron objects and surfaces, and industrial and marine environments
- 400ml can covers 1.4m². Dries in 1 hour. Overcoat in less than 1 hour, or after 24 hours



Product No	Colour	Finish	Size	Pack
PP207408	Grey	Matt	400ml	6
PP176803	White	Matt	400ml	6

Zinc Primer

- This anti-corrosive, gloss finish, primer has been specially formulated for long lasting, maximum corrosion protection of metallic surfaces
- It is a high yield coating rich in Zinc (minimum 99% pure Zinc) which adheres electro-chemically to the metal structure and offers excellent protection from the elements
- Cold Galvanized Zinc; based on Zinc powder and resins, which is both strong and flexible
- Ideal for use on metallic structures, fences, welded joints, repairs of galvanized pieces, railroad equipment, etc.
- 400ml can covers 1.4m². Dries in 1 hour. Overcoat in 1 hour



Product No	Colour	Size	Pack
PP121407	Silver	400ml	6

Primer For Plastics

- Colourless primer for most plastics
- Obtain the best adhesion before applying the final finish
- Ideal for use on plastic items such as automotive bumpers and spoilers, furniture, hard suitcases, toys, models etc.
- 400ml can covers 3-4m². Dries in 15 minutes. Overcoat in 15 minutes



Product No	Colour	Size	Pack
PP213805	Clear	400ml	6

Spray Gun

- Universal adapter for all types of aerosols
- Designed for long working days
- Designed to improve the painting experience by avoiding hand fatigue
- The mechanism of the gun is simple and very robust
- Ergonomic handle
- Fits most aerosol cans



Product No	Pack
PP239607	10

Pinty Plus POS Displays

- Contact us for details on display fills



PINTYPLUS EVOLUTION

WATER-BASED PAINT



ULTRA LOW ODOUR



SUITABLE ON ALL SURFACES



SUPER SMOOTH FINISH



WORRY-FREE RECOAT



Owatrol Oil

- Paint conditioner and rust inhibitor
- Can be used alone or added to oil based paints, primers, varnishes and stains
- Used alone it provides a tough, flexible finish, driving out moisture and air
- Used alone: coverage 18m²/litre



Product No	Size	Pack
OW728	125ml	24
00059	500ml	12
00103	1L	12
307346	5L	4
OW730	Aerosol 300ml	12

E-B Bonding Primer

- Helps paint stick to unstable surfaces
- Bonding stabilising primer which mixes into water based paints
- Saves labour and time
- Stops paint peeling
- Improves paint hiding power



Product No	Size	Pack
04110	1L	12
410030	2.5L	4

ESP

- Prepares non-porous surfaces for painting
- Leaves a bonding film on the surface for paint to stick to
- Ideal for melamine, glass, ceramic tiles, painted and varnished surfaces
- Does not soften, remove or dull the old finish
- May be coated anytime after 2 hours
- Interior and exterior use



Product No	Size	Pack
00710	1L	12

Floetrol

- Increases paint flow, leveling and workability
- Extends the paint's 'wet edge' to eliminate brush and roller marks
- Reduces tip clogging when spraying
- Increases covering power



Product No	Size	Pack
300106	1L	12
00106	2.5L	4

Net-Trol

- Restores natural colour and beauty to wood
- Removes dirt and stains
- Brightens grey weathered wood
- Easy to apply and use
- Concentrated formula
- Cleans hardwood and softwood
- Can also be used to clean concrete, stone, plastic and GRP
- Will not harm plants or shrubs



Product No	Size	Pack
011210	1L	12
100256	2.5L	4

Seasonite

- Protects new and pressure treated wood
- Keeps new wood looking new for longer
- Reduces damage from sun and rain
- Prevents splitting, swelling and cupping
- Provides mildew resistance
- Convenient one coat application
- Easy to apply, even to damp wood



Product No	Size	Pack
010250	1L	12
408911	2.5L	4

Textrol

- High solids penetrating oil finish
- Enhances the natural beauty of the wood
- Protects against water damage
- Easy to apply and maintain
- Provides mildew resistance
- Does not crack or peel



Product No	Colour	Size	Pack
010226	Clear	1L	12
OWA800	Clear	2.5L	4
050226	Clear	5L	4
904GB	Golden Oak	1L	12
906GB	Golden Oak	5L	4
909GB	Rustic Oak	1L	12
911GB	Rustic Oak	5L	4

Deks Olje D.1

- Unique saturating oil
- Replaces natural oils in timber
- Drives out moisture and air from timber pores
- Can be used on internal and external timber, including below the waterline on wooden hull boats
- Matt finish



Product No	Size	Pack
DEK1	1L	12
108324	2.5L	4

Deks Olje D.2

- Finish coat for wood treated with Deks Olje D.1
- Tough, flexible and durable
- No need to sand between coats
- High gloss finish



Product No	Size	Pack
DEK2	1L	12
108423	2.5L	4

Prep-Deck

- Strips old finishes and stains from exterior wood
- Cleans weathered wood
- Reduces mill glaze
- Eliminates grade stamps



Product No	Size	Pack
499AA	2.5L	4

Warmcoat

- Reduces condensation and prevents mould growth on internal walls
- Makes a noticeable difference to room temperatures in older buildings with solid or old cavity block walls
- Keeps rooms warmer for longer
- Increases average room temperature by as much as 3°C with the same heating settings
- Allows walls to breathe
- Cuts heat loss and saves on energy bills
- Ideal for ceilings and walls of older flat roof extensions, garages etc
- Can be over painted with any type of paint



Product No	Finish	Size	Pack
THERMWCMT	Matt	5L	2

Barrettine
TRUSTED BY THE PROFESSIONALS

ArmourFlex
• Hard-wearing • Flexible • Protection



MATT FINISH SATIN FINISH

**Tough on Stains,
Dirt & Scratches**
Great results every time.



Enhancing Woods Natural Beauty

Armourflex® Hardwax Oil for wooden floors, stairs, kitchen worktops & furniture is a specialist high-performance coating that offers a natural and elegant finish with exceptional wear characteristics and high scratch resistance. Containing a blend of natural oils and waxes its microporous, breathable finish doesn't crack, peel, flake, or blister. Armourflex® Hardwax Oil is suitable for protecting and enhancing all interior wood surfaces including hardwood, softwood, parquet, and veneer.

Inspired by nature, led by design, Armourflex® Hardwax Oil is certified Food & Toy Safe when dry to EN 1196:2002 & EN71-3. Treated surfaces are easy to maintain and very low maintenance, should any damage occur it is easily spot repaired compared to varnishes. Its natural and elegant finish enhances the wood grain and complements a range of modern and classic interior styles, whilst protecting the overall investment of expensive wooden floors, stairs, kitchen worktops & furniture.

Sizes: 1 Litre, 2.5 Litre



QUICK & EASY RESULTS

- 4 HOUR DRYING TIME ✓
- MANUFACTURED IN THE UK ✓
- CERTIFIED FOOD & TOY SAFE WHEN DRY ✓
- STAIN, DIRT & HIGH SCRATCH RESISTANT ✓

★★★★★
5* Star Performance



ArmourFlex Hardwax Oil

A blend of natural oils and waxes, suitable for protecting and enhancing the durability of all interior wood surfaces including hardwood, softwood, parquet and veneer. Resistant to common stains such as wine, beer, fruit juice, carbonated soft drinks, tea, and coffee. Food/Toy safe when dry, certified by EN 1186:2002 & EN71:3.

- Tough durable protection for wooden floors and furniture
- Natural oils and waxes providing excellent water repellency
- Stain, dirt and scratch resistant
- Repairing damage and scratches is easy with a simple touch up
- Suitable for interior wood surfaces including hardwood, softwood, parquet and veneer



Product No	Finish	Size	Pack
HWOM001	Matt	1L	6
HWOM2.5	Matt	2.5L	4
HWOS001	Satin	1L	6
HWOS2.5	Satin	2.5L	4

ArmourFlex Ultimate UV Protection Oil

- Ultimate UV Protection Oil is a premium blend of natural oils, waxes, and resins
- Incorporating the latest UV stabilising technology to protect against weathering and UV damage that causes wood to swell, twist and grey
- The transparent/clear oil and wax formula imparts excellent water repellence to both softwood and hardwood, giving a microporous finish which is resistant to flaking, peeling, cracking and blistering
- Ideal for all exterior wood types including doors, windows and structural timber
- Specially designed to capture the sun's UV rays and dissipate them safely as heat
- Contains film biocide



Product No	Size	Pack
AFUV001	1L	6
AFUV2.5	2.5L	4
AFUV004	4L	2

Contact us for details on display fills

Woodworm Killer

A traditional deep penetrating low odour solvent based woodworm killer which prevents and exterminates woodworm and woodboring insects from timber. Ideal for treating furniture, flooring, structural timbers etc. Avoid contact with plastics, roofing felts etc. Kills all common insects including Common Furniture Beetle, House Longhorn Beetle, Powder Post Beetle and wood boring Weevils. Also kills larvae and eggs when in direct contact.

- Contains Permethrin
- Protects uncontaminated timber against wood boring insect attack
- Suitable for use on all types of internal and external timber, rough, sawn or smooth
- Treated timbers can be polished, stained, varnished or painted when dry
- Approved under COPR/BPR
- Harmless to plants and pets when dry
- Deep penetrating
- Low odour
- Ready to use formulation



Product No	Size	Pack
SPWW001	1L	6
SPWW2.5	2.5L	4
SPWW005	5L	2

NOT FOR SALE IN THE REPUBLIC OF IRELAND

Woodworm Killer Spray

- All the properties of Woodworm Killer, but in a handy spray bottle



Product No	Size	Pack
SPWW.50	500ml	6

NOT FOR SALE IN THE REPUBLIC OF IRELAND

Wood Preserver

A high quality, low odour, solvent based, deep penetrating preserver which is used for the protection against wood destroying fungi (wet rot), wood discolouring fungi and wood boring insects. Provides a semi-transparent finish allowing the natural wood texture to be visible. No subsequent top coat product required unless for aesthetic purposes. For outdoor use including on window frames, external doors and frames. The clear product can also be used on structural timbers in unoccupied areas such as floor joists.

- Contains Permethrin, Tebuconazole and IPBC
- Protects uncontaminated timber against wet rot, decay and wood boring insect attack
- Mainly for external applications but some internal
- Approved under COPR/BPR
- Suitable for rough, sawn or smooth timber, and does not require over sealing
- Harmless to plants and pets when dry
- Solvent based for deeper penetration
- Low odour
- Ready to use formulation
- Superb quality water repellent resins
- UV fade resistant colour pigments
- High level, long lasting protection and preservation



Product No	Colour	Size	Pack
WOC005	Clear	5L	2
WODB005	Dark Brown	5L	2
WOLB005	Light Brown	5L	2
WORC005	Red Cedar	5L	2
WOHG005	Holly Green	5L	2
WOCB005	Golden Brown	5L	2
WOST005	Summer Tan	5L	2
WOBL005	Black	5L	2

Wood Protective Treatment

An ideal wood treatment for outdoor timber structures such as sheds, fences, trellis, pergolas and timber gazebos. A low build film product that absorbs into the wood with successive coats building onto the surface to give excellent water repellence and beading. Contains water repellent resins and film biocide preserver to prevent surface growth of mould and algae and together this helps reduce decay, swelling, twisting of wood.

- For use on most external pre-treated timbers
- Contains film biocide preserver to prevent surface growth of mould and algae
- Suitable for rough, sawn or smooth timber, but not suitable for garden furniture unless over sealed
- Harmless to plants and pets when dry
- Solvent based for deeper penetration
- Low odour
- Superb quality water repellent resins
- UV fade resistant colour pigments
- High level, long lasting protection



Product No	Colour	Size	Pack
PTCL2.5	Clear	2.5L	4
PTCL005	Clear	5L	2
PTDB2.5	Dark Brown	2.5L	4
PTDB005	Dark Brown	5L	2
PTLB2.5	Light Brown	2.5L	4
PTLB005	Light Brown	5L	2
PTRC2.5	Red Cedar	2.5L	4
PTRC005	Red Cedar	5L	2
PTHG2.5	Holly Green	2.5L	4
PTHG005	Holly Green	5L	2
PTGB2.5	Golden Brown	2.5L	4
PTGB005	Golden Brown	5L	2
PTBL2.5	Black	2.5L	4
PTBL005	Black	5L	2
PTST005	Summer Tan	5L	2



Barrettine's Woodcare range includes professional protective treatments for all exterior wooden structures.

// PREMIER WOOD PRESERVER

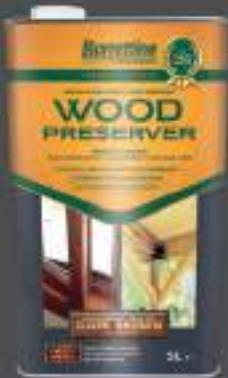

PREMIER WOOD PROTECTIVE TREATMENT



// PREMIER WOODWORM KILLER TREATMENT



ArmourFlex[®]

• Hard-wearing • Flexible • Protection

Manufactured in the UK 



LONG LASTING, PROFESSIONAL PROTECTION AGAINST Weathering & UV Damage



SPECIALLY DESIGNED TO CAPTURE THE SUN'S UV RAYS & DISSIPATE THEM SAFELY AS HEAT

Armourflex[®] Ultimate UV Protection Oil offers a cost-effective solution to protecting exterior wood building facades and vertical surfaces from damaging UV rays and weathering, extending the service life of the timber and reducing long term maintenance expense.

- ✓ Slows Greying & Deterioration
- ✓ No Flaking or Peeling
- ✓ Excellent Water Beading
- ✓ Interior & Exterior Use



Barrettine
TRUSTED BY THE PROFESSIONALS

★★★★★
5* Star Performance

Danish Oil

- A natural oil blend
- Primes, seals and finishes all wood and veneered surfaces
- Achieves a low lustre finish
- Internal and external use



Product No	Size	Pack
OIDA.25	250ml	6
OIDA.50	500ml	6
OIDA2.5	2.5L	4
OIDA005	5L	2

Raw Linseed Oil

- Traditional wood treatment for quick penetration and rich nourishment of unpolished timber
- Also used for the treatment of new timber prior to painting



Product No	Size	Pack
OIRL.25	250ml	6
OIRL.50	500ml	6

Boiled Linseed Oil

- Linseed oil with added driers
- Seals wood and gives an attractive darker finish with a reddish tint



Product No	Size	Pack
OIBL.25	250ml	6
OIBL.50	500ml	6
OIBL005	5L	2

Teak Oil

- For the treatment and enhancement of all treated wood, including hardwood
- Ideal for garden furniture or a traditional matt finish on interior furniture



Product No	Size	Pack
OITE.25	250ml	6
OITE.50	500ml	6

Patent Knotting

- Seals knots prior to priming and undercoating
- Ideal for use on new or stripped wood



Product No	Size	Pack
POPK.25	250ml	6
POPK.50	500ml	6

White Knotting

- Seals knots prior to priming and undercoating
- Particularly for use with lighter paints



Product No	Size	Pack
POWK.25	250ml	6

Button Polish

- A shellac polish for use on wood to give a very hard brown finish



Product No	Size	Pack
POBU.25	250ml	6

White French Polish

- Gives a rich shiny appearance to light timber



Product No	Size	Pack
POWF.25	250ml	6

Brown French Polish

- Gives a rich shiny appearance to dark wood surfaces



Product No	Size	Pack
POBF.25	250ml	6

Sanding Sealer

- Seals new and stained timber, including MDF
- For use prior to application of other finishes



Product No	Size	Pack
POSS.25	250ml	6
POSS002	2L	6

Terebine Driers

- Improves drying times of alkyd and oil based paints



Product No	Size	Pack
POTD.25	250ml	6

Natural Beeswax

- Formulated from a traditional blend of natural waxes and oils
- Imparts a gentle even sheen
- Maintains water repellence
- Used for cleaning and finishing sealed or previously polished wood



Product No	Size	Pack
CRBE.25	250ml	6

Creosolve

- A lower hazard alternative to traditional Creosote
- Does not contain biocides
- Bitumen and wax treatment that helps to protect exterior timber by repelling water thus preventing water ingress



Product No	Colour	Size	Pack
CRSOD04	Dark Brown	4L	4
CRSOL04	Light Brown	4L	4

Paint Panther

- A highly effective incredibly fast paint and varnish stripper
- Removes many types of coatings
- Easy to apply gel formula
- Ideal for vertical and other less accessible areas to be treated
- Methylene chloride free
- Voted - DIY Decorating Product of the year, gold winner!
- Will also strip metalised paint



Product No	Size	Pack
STPP50	500ml	6
STPP001	1L	6
STPP2.5	2.5L	4
STPP004	4L	2

Water Seal

- Solvent-based breathable clear water repellent and protector for brickwork, aged concrete, render, pointing, terracotta and wood
- Not suitable for use on plywood
- Matt finish on porous surfaces
- Theoretical coverage 6m²/litre



Product No	Size	Pack
SPWS005	5L	2

Peelaway 1

Peelaway 1 is a water-based poultice system paint stripper that is most often used for restoration projects involving multiple layers of oil based paints. The stripping compound is formulated to quickly react with the paint resins and convert any lead present into a compound that can be safely disposed of without endangering the environment. Peelaway 1 is a high pH product, which means that the stripped surface should be neutralized with a weak solution of acetic acid (supplied with the packs). If the surface is to be re-painted, it should first be primed with an alkaline resistant primer. Test patches should always be carried out prior to the main application to assess the suitability of the final finish.



Product No	Size	Pack
PEA17PK	1 & 7 Sample Pack	1
PEA1005	5kg	1
PEA1015	15kg	1
PEAN001	1L Neutraliser	6

Spare Blankets

Product No	Size	Pack
PEA1B10	Pack of 10	10

Peelaway 7

Peelaway 7 is the new modern alternative to Peelaway 1. Peelaway 7 is a water and solvent-based paste which is formulated to remove more modern water-based coatings. Excellent results have also been achieved with combinations of oil and water-based coatings. Peelaway 7 does not require neutralizing and the surface can be repainted within a few hours. It is much safer and more user friendly. It is non-caustic and does not burn the skin in the event of accidental contact. Test patches should always be carried out prior to the main application to assess the suitability of the final finish.



Product No	Size	Pack
PEA17PK	1 & 7 Sample Pack	1
PEA7.75	750g	6
PEA7004	4kg	1
PEA7010	10kg	1

Spare Blankets

Product No	Size	Pack
PEAB010	Pack of 10	10

Genuine Turpentine

- Organic naturally based solvent
- Particularly favoured by artists for use with oil paints as a cleaner and thinner



Product No	Size	Pack
TUGE.25	250ml	6
TUGE.50	500ml	12
TUGE002	2L	6

Low Odour White Spirit

- All the features of traditional White Spirit but with a milder odour
- Ideal for use internally and in confined spaces



Product No	Size	Pack
WHSBL.75	750ml	12
WHSBL002	2L	8

Paraffin

- Refined to BS2869 Class 1 and may be used in all appliances recommending this classification



Product No	Size	Pack
PAPR004	4L	4

Methylated Spirit

- Suitable for cleaning, lighting and heating
- Also used as a thinners for French Polish



Product No	Size	Pack
MMSS.50	500ml	12
MMSP002	2L	6
MMSP005	5L	4

Brush Restorer

- Provides a quick and effective method of removing hardened paint and varnishes from old and neglected brushes, rollers and other painting tools



Product No	Size	Pack
BRRE.50	500ml	12

Multi-Purpose Linseed Oil Putty

- A traditional blend of high-quality linseed oil and fillers
- Specially formulated for glazing both wood and metal window frames and used by both the professional tradesman as well as the home owner
- Equally useful as a general wood filler



Product No	Colour	Size	Pack
PUMN.50	Natural	500g	12
PUMN001	Natural	1kg	12

Border & Overlap Adhesive

- Used primarily for fixing decorative borders to interior surfaces and for minor repairs to existing wallcoverings
- Simple to apply
- High grab properties
- Formulated as suitable for vinyl over vinyl applications



Product No	Size	Pack
BORD5	500g	12
BORD1	1kg	6

Easi Paste Ready Mixed Wallcovering Adhesive

- Ideal for use when papering feature walls
- No mixing required
- Suitable for use with both 'paste the wall' and traditional wallpapers
- Easy spreading formulation



Product No	Size	Pack
MAV552229	2.5kg	8
58510930	5kg	2
MAV552168	10kg	2

Professional Ready Mixed Wallcovering Adhesive

- Ready to use, high quality wallcovering adhesive
- Especially formulated for use with luxury vinyls (both paper and fabric backed), hessians, covings and polystyrene tiles and veneers
- Manufactured from a hot blend of high quality starch and PVA emulsions
- The formulation is engineered towards the professional user
- Whilst the product is supplied ready-to-use, it may be thinned by adding water if necessary



Product No	Size	Pack
58510390	2.5kg	8
58510400	5kg	2
58510410	10kg	2

Wallpaper Adhesive Powder

- All purpose wallpaper paste
- Easy to mix
- 3 pack size options
- Available in counter top display option



Product No	Size	No of Rolls	Pack
MAV211440	6 pint	5	25
MAV211457	12 pint	10	12
59943260	36 pint	30	24

PVA Adhesive & Sealer

- Multi-purpose product suitable for a variety of applications
- Bonds most materials including brick, wood, ceramic tiles, carpet, cardboard, polystyrene, fabric, leather and porous substrates
- Use as a primer and dustproofer for mortar surfaces such as concrete and plaster
- Especially suitable as an additive to cement to increase adhesion properties



Product No	Size	Pack
58505190	1L	6
58505210	5L	4

Fix & Grout

- A high quality tile adhesive
- Ideal for use when applying ceramic tiles in areas of high humidity such as kitchens and bathrooms
- May also be used as a ready to apply grout, negating the need for a separate tile grout product
- Ideal for fixing loose and broken tiles to wood and most other surfaces subject to small movement



Product No	Size	Pack
52850120	330g tube	12
52850150	500g	12
52850130	1kg	12

Original Cleaner/Degreaser

- Concentrated cleaner, degreaser and stain remover that quickly and easily removes tough stains from many different surfaces
- Cleans what ordinary cleaners simply can't
- Water-based
- Contains no petroleum solvents, bleach or ammonia
- Removes grease, grime, oil, tar and wax fast
- Removes dried latex paint
- Suitable for interior and exterior use



Product No	Size	Pack
KK130011	750ml	6

Gloss Off

- Specially designed to prepare high gloss and other hard-to-stick-to surfaces for repainting or refinishing
- No rinse formula
- Specially formulated to help new paint and varnish bond to old finishes, or as a wall preparation prior to wallpapering
- It can be used on all painted, varnished and lacquered surfaces and removes dirt, grease, grime, smoke, food stains, heel marks, crayon, old wallpaper paste, and wax residue from painted or unpainted wood and metal
- Increases paint adhesion
- Cleans and de-glosses without sanding
- Can be coated after only 10 minutes



Product No	Size	Pack
KK130028	750ml	6

Standard Thinners

- Thinners for cellulose paints and primers, cleaning brushes and equipment and removing excess paint



Product No	Size	Pack
CETH.50	500ml	12
STT005	5L	4
STT025	25L	1

Spray Adhesive

- A high tack, wide coverage aerosol
- Perfect for adhesion of artwork, displays, vehicle interiors etc



Product No	Size	Pack
TAD400	400ml	6

Graffiti Remover

- Fast and effective way to remove unwanted spray paint, marker pen, ink and crayon from brickwork, glass, wood and metal
- Can also be used to remove permanent pen from whiteboards
- Effective on rough or smooth surfaces



Product No	Size	Pack
TGR500	500ml	6

Sugar Soap Concentrate

- Formulated for the cleaning and preparation of surfaces prior to painting
- Suitable for general household cleaning
- Effective on grease, dirt, wax, tobacco and general stains on painted surfaces
- 500ml makes 22.5L of ready-to-use solution
- Mixes instantly in hot or cold water
- Non-caustic and non-irritant



Product No	Size	Pack
TSU500	500ml	6
TSU010	1L	4

Sugar Soap Powder

- All the features of Sugar Soap Concentrate but supplied as a powder
- 500g makes 9L of ready-to-use solution
- Does not contain silicates or sodium hydroxide
- Non-abrasive
- Non-flammable



Product No	Size	Pack
TSU501	500g	12

Sugar Soap Spray

- Ready to use formulation in a spray bottle
- no messy preparation
- Similar working characteristics to Sugar Soap Concentrate



Product No	Size	Pack
TSU502	500ml	6

Brush Cleaner

- Cleans wet brushes and rollers
- Softens paint hardened brushes
- Suitable for all types of brushes and rollers
- Powerful, fast acting formula
- Better cleaning action than white spirit



Product No	Size	Pack
BCL055	500ml	12

Wallpaper Stripper

- Concentrate – 500ml makes up to 45L of solution
- Suitable for stripping light, medium, heavyweight and washable papers
- Powerful, fast acting formula
- Actively penetrates paper and dissolves the wallpaper adhesive



Product No	Size	Pack
TWP500	500ml	6

Mould & Mildew Remover

- Kills and prevents mould, algae and fungus growth
- Remains active for up to 6 months
- Handy trigger spray bottle
- Powerful, fast acting formula



Product No	Size	Pack
TMO500	500ml	6

Make Good Primer Bonder

- A new-technology, multi-functional primer, sealing agent, key coat and bonding aid
- Designed for use prior to decoration or surface treatment, it can make the difference between an obvious DIY-job and a professional looking finish
- As a primer it can be used to treat dusty and porous surfaces
- As a key coat it is ideal for new plaster, mortar and concrete repairs, renders and screeds
- As a sealant it can be used to seal and dustproof cementitious or plaster/ powdery substrates



Product No	Size	Pack
TPR001	1L	6

Make Good 4 in 1

- A high performance, multi-purpose, professional quality sealant and adhesive which utilises IPT- Inert Polymer Technology
- Capable of outperforming conventional products, specific to their use, such as silicone sealants, butyl/acrylic sealants and adhesives, as well as conventional fillers
- Use as a sealant, adhesive and filler
- Use for grip in wet or outdoor environments



Product No	Size	Pack
IPT330	330g	12

Make Good Fix A Leak

- A new technology, rubberised coating which can protect items and products from moisture and weathering, and can also fill and seal fine leaks and cracks
- Provides a tough, water tight, yet flexible seal which can plug and stop leaks on certain substrates



Product No	Size	Pack
TFL400	400ml	6

Make Good Seal & Waterproof

- A visco-elastic, abrasion resistant durable coating
- Provides effective protection and sealing power to guttering, pipework, flat roofing, metal panels and even vertical surfaces
- It is thixotropic, so that thick films can be quickly achieved
- Not suitable for over-painting



Product No	Size	Pack
TWP400	400ml	6

Powerfil

- 2 part formulation
- Hardens within 15 minutes
- Super strong
- Non-slumping
- Suitable for use on most hard surfaces
- Cures fully to any depth in one application
- Will not shrink or crack



Product No	Size	Pack
TKK250	250g	12
TKK600	600g	6
TKK001	1kg	6

Professional Stonefil

- Fast setting, waterproof fillers for the repair and restoration of natural and ornamental stone and ceramics
- Existing stone can be matched in colour, by the addition of stainers or stone dust
- Can also be used as an adhesive
- Suitable for interior and exterior use
- Can be overpainted in 30 minutes



Product No	Colour	Size	Pack
TSF015	Clear	900ml	6
TSF016	White	900ml	6
TSF105	Straw	900ml	6

Professional Woodfil

- Two part woodfiller
- Fast setting
- Super smooth finish
- Can be drilled, sanded, carved and painted
- Suitable for interior and exterior use
- Two colour options



Product No	Colour	Size	Pack
WFN402	Natural/Pine	400g	12
WFN012	Natural/Pine	1.2kg	6
WFW402	White	400g	12
WFW012	White	1.2kg	6

Hard As Rock Filler

- Touch dry in 2 hours
- Accepts bolts and screws
- Will not shrink or crack
- Weatherproof formula
- For all exterior filling jobs



Product No	Size	Pack
TEF330	330g	12



Smart Filler

- Quick-drying, ready mixed lightweight filler
- Specifically formulated to leave a super smooth white finish in just one application
- Requires little or no sanding before painting
- Capable of filling deep holes and crevices in one application without slumping or shrinking
- Will support screws and nails into firm substrates without the need for wall plugs
- Suitable for interior and exterior use



Product No	Size	Pack
TST500	500ml	6

Hard As Rock Filler

- Fully cures to 5 times harder than concrete
- Sets hard in 60 minutes
- Ideal for heavy duty repairs
- Completely waterproof
- Anchors bolts, pins and posts into floors and walls
- Ideal for repairing step 'nosings'



Product No	Size	Pack
TSF200	2kg	8

Easy On Interior Filler

- Powder filler for interior repairs
- Will not flash through
- Achieves a tough, smooth finish
- Will not crack or shrink



Product No	Size	Pack
TMF500	500g	12
TMF015	1.5kg	8

All Purpose Filler

- Suitable for both interior and exterior use
- Tough and water resistant
- Seals, bonds and fills most building materials
- Vibration and shrink resistant
- Very smooth finish
- Can be drilled and tapped
- 5kg and 10kg sizes contain individual packs



Product No	Size	Pack
TFP512	500g	12
TFP015	1.5kg	8
TFP050	5kg	2
TFP010	10kg	1

Flexible Woodfil

- Fills gaps, cracks and holes in wood
- Flexes with the natural movement of the timber
- Can be stained, varnished or painted
- Supplied in natural colour
- Suitable for interior and exterior use
- Water resistant
- Range includes a handy 330g tube



Product No	Size	Pack
WFN330	330g	12
TWF606	600g	6

Fine Surface Filler

- Ideal for filling fine cracks and chips in wood and plaster
- Super smooth finish
- Ready mixed
- Needs only light sanding before painting
- Suitable for interior and exterior use



Product No	Size	Pack
TFS330	330g	12
TFS606	600g	6

All Purpose Ready Mixed Filler

- All Purpose Ready Mixed Filler has all the attributes of All Purpose Powder Filler but with the added advantage that it is ready to use and can be used in small quantities, with no wastage



Product No	Size	Pack
DTE330	330g	12
TRM606	600g	6
TRM106	1kg	6
TRM002	2kg	6

FIND YOUR PERFECT FILLER.

WHATEVER THE JOB, WHATEVER ITS SIZE,
WHATEVER THE SURFACE, OUR COMPLETE
RANGE OF HIGH QUALITY FILLERS HAS
THE ANSWER.



toupret.co.uk     

TOUPRET[®]
FILLERS FOR PROFESSIONALS

Interior Filler

- For repairs on walls and ceilings
- Will not shrink or slump
- Easy to sand
- No need to spot prime
- Will not flash or grin
- No depth limit
- Ready to paint in 12+ hours
- White in colour



Product No	Size	Pack
TP018569	1kg	8
TP018576	2kg	8
TP018583	5kg	4
TP018590	10kg	1



Quick Dry Filler

- For quick repairs on walls and ceilings
- Will not shrink or slump
- Excellent adhesion and easy to sand
- No need to spot prime
- Will not flash or grin
- No depth limit
- Ready to paint in 3 hours
- White in colour



Product No	Size	Pack
TP018606	1kg	8
TP018613	2kg	8
TP018620	5kg	4
TP018637	10kg	1

Ready To Use Filler

- For repairs on walls and ceilings
- Easy to apply
- Easy to sand
- No need to spot prime
- Will not flash or grin
- Ready to paint in 12+ hours
- White in colour



Product No	Size	Pack
TP018835	330g	12
TP018873	1.5kg	6
TP018934	4kg	1

Quick Fill Interior

- For one coat repairs on walls and ceilings
- Will not shrink or slump
- Easy to sand
- No need to spot prime
- Will not flash or grin
- No depth limit
- Ready to paint in 30 minutes
- White in colour



Product No	Size	Pack
TP018927	1L	6
TP018941	4L	1

Fine Surface Filler

- For fine smoothing over small defects
- Adheres to paintwork
- Easy to sand
- No need to spot prime
- Will not flash or grin
- Ready to paint in 8 hours
- White in colour



Product No	Size	Pack
TP018842	330g	12
TP018880	1.5kg	6
TP018958	4kg	1

Plaster Of Paris

- For shaping and moulding
- Easy to shape and mould
- Quick setting
- Extra fine
- Easy to sand
- No depth limit
- Ready to paint in 24+ hours
- Extra white in colour



Product No	Size	Pack
TP018644	4kg	4

Renovation Skimcoat

- Ready to use filler for levelling and finishing damaged and textured surfaces
- Ideal for covering textured and rough surfaces
- Certified for plasterboard jointing
- No PVA required
- No need to spot prime
- Easy to sand
- Ready to paint in 12+ hours
- White in colour



Product No	Size	Pack
TP019054	10kg	1

**DON'T CHANCE IT.
TOUPRET IT.**

CHOOSE ONLY THE BEST, OUR COMPLETE RANGE OF TOP QUALITY FILLERS PERFORMS PERFECTLY WHATEVER THE JOB, GUARANTEEING TOTAL SATISFACTION EVERY TIME.



TOUPRET[®]
FILLERS FOR PROFESSIONALS

Masonry Repair Filler

- Can be applied to damp masonry
- Weather resistant
- Shapeable - repair without formwork
- No need to seal the substrate
- No depth limit
- Ready to paint in 48+ hours
- Light grey in colour



Product No	Size	Pack
TP018712	1.5kg	8
TP018729	5kg	4
TP018736	15kg	1

Tough Multi-Filler

- For filling, repairing and localized skimming
- Reinforced with fibres for extra strength
- Tough, with excellent adhesion
- Easy to sand
- No need to seal the substrate
- No depth limit
- Ready to paint in 24+ hours
- White in colour



Product No	Size	Pack
TP018651	2kg	8
TP018668	5kg	4
TP018675	10kg	1

Rock Solid Repair Filler

- Extreme durability and adhesion on any substrate
- Rich in resin
- Fills and repairs all substrates
- Shapeable - repair without formwork
- No need to seal the substrate
- No depth limit
- Ready to paint in 24+ hours
- White in colour



Product No	Size	Pack
TP018682	2kg	8
TP018699	5kg	4
TP018705	10kg	1

Quick Fill Exterior

- For one coat exterior repairs
- Lightweight and ready to use
- Will not shrink or slump
- Rich in resin
- No need to seal the substrate
- No depth limit
- Ready to paint in 1 hour
- Light grey in colour



Product No	Size	Pack
TP018910	1L	6
TP018965	4L	1

Skimcoat Filler

- For smoothing damaged and rough masonry and render
- Extra smooth
- Easy to spread
- Long working time
- Allows the substrate to breathe
- No need to seal the substrate
- Ready to paint in 24+ hours
- White in colour



Product No	Size	Pack
TP018743	5kg	4
TP018750	15kg	1

Ready To Use Skimcoat Filler

- For smoothing damaged and rough masonry and render
- Easy to spread
- Flexible - resists cracking
- Suitable for manual or spray application
- Allows the substrate to breathe
- No need to seal the substrate
- Ready to paint in 24+ hours
- Off-white in colour



Product No	Size	Pack
TP019047	10L	1

Fill-Flex

- Flexible filler for gaps and cracks
- Adheres to plaster, masonry, primed wood and paintwork
- Highly flexible: will not crack
- Moves with the substrate
- No need to spot prime
- Ready to paint in 24+ hours
- White in colour



Product No	Size	Pack
TP018859	310ml	12
TP018903	1kg	6

Skim-Flex

- Flexible skimcoat for moving and tiled substrates
- Exceptional adhesion, even on tiles
- Ideal for kitchens and bathrooms
- Easy to spread and sand
- Remains flexible when dry
- Ready to paint in 24+ hours
- White in colour



Product No	Size	Pack
TP018972	5kg	4

Scrim

- For reinforcing inert or moving cracks
- Open-weave mesh
- No fraying edges
- Recommended for use with Toupret fillers
- Available in 2 types: Self Adhesive or Fine



Product No	Type	Size	Pack
TP520208	Self Adhesive	5cm x 20m	5
TP529034	Fine	5cm x 20m	5

Anti-Damp Render

- Breathable barrier for damp, porous and untreated masonry
- Ideal for basements and garages
- Exteriors: blocks water penetration
- Interiors: acts as a water barrier, while letting substrates breathe
- No need to seal the substrate
- Ready to paint in 24+ hours
- Off-white in colour



Product No	Size	Pack
TP018767	6kg	4

Anti-Damp Treatment

- Moisture barrier
- Blocks localised problem moisture
- Covers micro-cracks
- Apply with brush or roller
- Ready to paint in 24+ hours
- White in colour



Product No	Size	Pack
TP018811	1L	6

Wall Hardener

- Improves the adhesion of fillers and coatings
- Stabilising hardener
- Hardens loose or powdery substrates
- Fast penetrating
- Ready to paint in 24+ hours
- White in colour



Product No	Size	Pack
TP018804	1L	4

Wood Repair Filler

- Easy to shape and quick drying on interiors and exteriors
- Easy to sand
- Compatible with all paints and coatings
- Can be drilled and screwed
- Low odour
- No depth limit
- Ready to paint in 3 hours
- Natural wood colour



Product No	Size	Pack
TP018774	1kg	8
TP018781	2kg	8

Wood Filler

- Ready to use on interiors and exteriors
- Easy to apply and sand
- Compatible with all paints and coatings
- Can be drilled and screwed
- Low odour
- Ready to paint in 12+ hours
- Natural wood colour



Product No	Size	Pack
TP018866	330g	12
TP018897	1.25kg	6

Wood Hardener

- Improves adhesion of fillers and coatings on interiors and exteriors
- Toughens rotten wood
- Adheres to damp wood
- Deep penetrating
- Water based
- Ready to paint in 24+ hours



Product No	Size	Pack
TP018828	1L	4

Glazing Putty

- Flexible - will not crack on interiors and exteriors
- Long-lasting
- Compatible with all paints and coatings
- Doesn't stick to hands
- Will not smear glazing
- Ready to paint in 6 days
- White in colour



Product No	Size	Pack
TP018798	1kg	6

BETTER FILLERS.
FASTER RESULTS.



PLASTERBOARD FINISHING SOLUTIONS

FINISH PLASTERBOARD WITH GREAT RESULTS FIRST TIME AND GET ON TO YOUR NEXT JOB FASTER

- EASY TO SAND
- ONE COAT
- NO NEED TO SPOT PRIME
- BS EN 13963 CERTIFIED FOR JOINTING



TOUPRET
FILLERS FOR PROFESSIONALS

Joint, Skim & Fill

- Filler for surface finishing, filling and plasterboard jointing
- Excellent coverage and finish, first time
- One coat for standard applications
- Easy to sand
- No shrinkage, no depth limit
- No need to spot prime
- CE approved for jointing applications
- Conforms to BS EN 13963



Product No	Size	Pack
TJSF0500	5kg	4
TJSF1000	10kg	1

Joint, Skim & Fill Quick Dry

- Quick drying filler for surface finishing, filling and plasterboard jointing
- Ready to paint in 3 hours
- One coat for standard applications
- Easy to sand
- No shrinkage, no depth limit
- No need to spot prime
- CE approved for jointing applications
- Conforms to BS EN 13963



Product No	Size	Pack
TJSQ0500	5kg	4
TJSQ1000	10kg	1

Joint & Skim Ready To Use

- Ready to use filler for surface finishing and plasterboard jointing
- Easy to sand
- Minimal shrinkage
- No need to spot prime
- For manual or spray application
- CE approved for jointing applications
- Conforms to BS EN 13963



Product No	Size	Pack
TP019221	10kg	1
TJSR2000	20kg	1

Patch & Repair Filler Quick Dry

- Quick drying filler for gaps, cracks, scratches and holes
- One coat for normal applications
- Easy to sand
- No shrinkage, no depth limit
- No need to spot prime



Product No	Size	Pack
TPRQ0100	1kg	8
TPRQ0200	2kg	8
TPRQ0500	5kg	4

Patch & Repair Filler Ready To Use

- Ready to use filler for gaps, cracks, scratches and holes
- Easy to sand
- Minimal shrinkage
- No need to spot prime
- Does not flash or grin



Product No	Size	Pack
TPRR0150	1.5kg	6

Rhynolite Yellow Aluminium Oxide Paper

- General purpose decorators' abrasive paper
- High performance aluminium oxide paper
- Excellent clog resistance for longer working life

Product No	Grit	Roll Length	Pack
C41508	40	5m	1
C40492	60	5m	1
C40184	80	5m	1
C40185	100	5m	1
C39099	120	5m	1
C42706	240	5m	1
C48829	40	10m	1
C48830	60	10m	1
C48831	80	10m	1
C48832	100	10m	1
C48833	120	10m	1
C48836	240	10m	1
C32420	40	50m	1
C32421	60	50m	1
C32422	80	50m	1
C32423	100	50m	1
C32424	120	50m	1
C32427	240	50m	1



Rhynsoft Foam Backed Pre-Cut Sanding Roll

- 5mm open cell foam backing
- Highly flexible
- Crease resistant
- Can be used wet
- Anti-clog abrasive coating
- Supplied in box dispenser
- Developed specially for hand sanding applications on curved and contoured surfaces
- More economic than foam sanding pads



Product No	Grit	Pack
602249	120	1
594148	180	1
594162	240	1
594186	320	1

Pro-Sponge Sanding Pad

- Double sided flexible abrasive pad
- 3 grit options
- Ideal for hand sanding curved and contoured surfaces
- Available in bulk pack of 250

Sanding Block

- Double sided abrasive foam block
- Supplied in a display box

Pro-Pad Abrasive Foam Pad

- Super flexible foam pad
- Excellent finishing product
- Silicon carbide abrasive
- 2 grit options
- Can be used wet



Product No	Grit	Pack
CSP-60	60	10
CSP-100	100	10
CSP-220	220	10
CSPBULK-60	60	1
CSPBULK-100	100	1
CSPBULK-220	220	1

Product No	Grit	Pack
C46299	60	50
C46300	100	50
C46302	220	50

Product No	Grit	Pack
CSPONGE-M	Medium	20
CSPONGE-F	Fine	20

Nylon Web Handpad

- Excellent de-nibbing product
- Waterproof
- Non-clogging



Product No	Grit	Pack
C45908	Medium	20
C45909	Very Fine	20

Rhynowood Sanding Sheets

- Aluminium oxide abrasive
- Excellent dry finishing paper
- 50 sheets per pack



Product No	Grit	Pack
CRWFP-80	80	1
CRWFP-150	150	1

Rhynowet Waterproof Sanding Sheets

- High performance aluminium oxide abrasive
- Can be used with water
- 25 sheets per pack

Product No	Grit	Pack
C00025	240	1
C00029	400	1



YellowLine



BE BETTER PREPARED FOR THAT QUALITY FINISH WITH YELLOW LINE ABRASIVE ROLLS FROM INDASA

Sustained all round sanding performance for surface preparation and fine finishing.

Wallrock Dampstop Thermic Adhesive

- Includes selected resin to adhere to difficult substrates including damp walls, metallic foils, polyester, polypropylene and walls in poor condition
- Contains inhibitors to prevent mould, yeast and fungal growth
- Typical consumption 1kg per 6m²



Product No	Size	Pack
MAV555817	1kg	12
MAV555824	2.5kg	4

Wallrock Dampstop Thermic

- Utilises a very tough, strong, rot proof and salt resistant polypropylene backing that will give a long service life even in very challenging conditions, bonded to a water resistant composite metallic barrier
- Zero paper content and zero tar content
- Each roll covers 5m² and is supplied in an extra wide width of 67.5cm to make containment of damp problems easier
- The rot proof backing can be applied directly to the wall with Wallrock Dampstop Thermic Adhesive, effectively blocking off the appearance of unsightly penetrating damp and staining
- The metallic surface can be covered with paint, thermally efficient wallcoverings, paste the wall lining papers or decorative paper
- Also greatly enhances the reflection of heat into the room - making the product especially useful in improving energy efficiency in the home when used behind radiators and appliances
- 7.5m roll length

Product No	Size	Pack
MAV555749	67.5cm x 7.5m	12

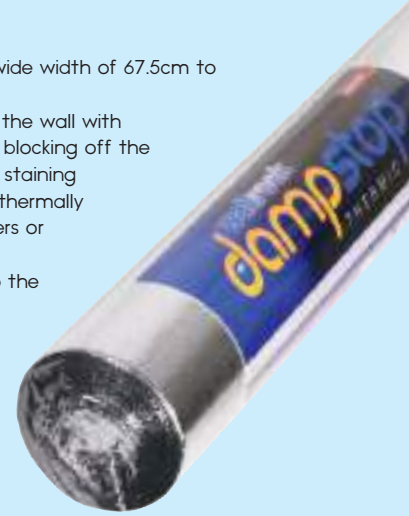

thermally efficient wallpaper



- ✔ Significant reductions in room warm up times.
- ✔ Significant reductions in energy consumption.
- ✔ Helps rooms retain cool conditioned air in warm climates.
- ✔ Covers problem areas such as damaged plaster.
- ✔ Combats condensation and mould formation.
- ✔ Reinforces surfaces permanently.
- ✔ Helps reduce noise transmission.
- ✔ Allows walls to breathe.
- ✔ Long service life.
- ✔ Contains no PVC.

thermal liner

save energy combat mould get cosy

Wallrock Thermal Liner

Wallrock Thermal Liner has been specially developed to offer a combination of features. First and foremost as an energy saving product, but with added benefits such as the ability to bring rough old plaster or textured surfaces 'back to flat'. Sound absorption and creating a healthier home by resisting mould and damp formation are just a couple of the added benefits. To achieve this, Wallrock Thermal Liner has been created with technology originally developed for the aerospace and automotive industries.

- Reduces room warm up times
- Covers cracked surfaces and damaged plaster
- Back to flat capability
- Combats condensation and mould formation
- Reinforces surfaces permanently
- Helps reduce noise transmission
- Allows walls to breathe
- Produces a tough stable surface for other wallpaper or paint
- Significant energy savings
- Contains no PVC or fibreglass

Product No	Size	Pack
MAV606009	75cm x 10m	1

Wallrock Thermal Liner Adhesive

- For use with Wallrock Thermal Liner
- Theoretical coverage 5kg/roll of Thermal Liner



Product No	Size	Pack
MAV553608	5kg	1

Wallrock Power Adhesive

- For use with Wallrock Fibreliner
- Theoretical coverage 5m²/1kg



Product No	Size	Pack
MAV216013	5kg	1
MAV216105	10kg	1

Wallrock Fibreliner Smooth

- A high performance lining paper that delivers great results every time
- With a smoother finish than standard lining paper resulting in lower paint consumption and a beautifully modern overall look
- Contains polyester textile fibres which act to reinforce the paper and the surface it is applied to
- Strength and stability ensure that it is easy to use, delivering perfect results that are resistant to expansion and shrinkage
- High tensile strength makes it ideal for covering cracked and damaged walls and in most cases stops the cracks reappearing completely
- Paste the wall or the paper
- Perfect surface for paint or decorative wallpaper
- Reinforces and smooths damaged walls and ceilings
- Tough and durable
- Allows walls to breathe
- Contains no pvc
- Dry strippable
- Uses paper from well managed sources
- Fire rated B-s1,d0



Product No	Size	Pack
MAV555589	55cm Single Roll	16

NEW wallrock dampstop THERMIC

DAMP BARRIER AGAINST PENETRATING DAMP
HEAT REFLECTOR TO REDUCE HEAT LOSS



- ✔ tough and durable
- ✔ combats penetrating damp
- ✔ reduces heat loss
- ✔ paste the wall

and wallrock fibreliner smooth

- ✔ tough and durable
- ✔ disguises imperfections
- ✔ smooths damaged walls
- ✔ paste the wall or paper
- ✔ added textile fibres for strength and durability
- ✔ perfect surface for paint or decorative wallpaper



Professional Lining Paper

- Smooths out walls in preparation for painting or overhanging with decorative wallpaper
- Excellent base surface
- Easy to use
- Contains no PVC or fibreglass
- Allows walls to breathe
- Uses paper from well managed FSC and PEFC sources



Product No	Grade	Pack
L016	800	24
L026	1000	20
L036	1200	16
L047	1400	16

Frog Tape Multi-Surface

- A medium adhesion painters tape designed for use on: cured painted walls (dried 3 days minimum), wood trim, glass, metal, untreated wood, carpet and stone
- In all cases, test on an inconspicuous area first
- It reacts with emulsion paint and instantly gels to form a micro-barrier that seals the edge of the tape, preventing paint bleed
- Will remove cleanly from most surfaces for up to 21 days, and seven days in direct sunlight



Product No	Size	Pack
157361	24mm x 41.1m	14
110137	36mm x 41.1m	10
260056	48mm x 41.1m	8

Frog Tape Delicate Surface

- A low adhesion painters tape designed for use on: freshly painted surfaces (dried for 24 hours minimum), primed plasterboard, treated wood, newly plastered walls and wallpaper
- In all cases, test on an inconspicuous area first
- It reacts with emulsion paint and instantly gels to form a micro-barrier that seals the edge of the tape, preventing paint bleed
- Will remove cleanly from most surfaces for up to 60 days



Product No	Size	Pack
179317	24mm x 41.1m	14
123201	36mm x 41.1m	10

Frog Tape Gloss & Satin

- A medium adhesion painters tape designed for use on: cured paint (dried for 3 days minimum), windows, glass, carpet, stone and untreated wood
- In all cases, test on an inconspicuous area first
- It reacts with gloss and satin paints and instantly gels to form a micro-barrier that seals the edge of the tape, preventing paint bleed
- Will remove cleanly from most surfaces for up to 21 days, and 7 days in direct sunlight



Product No	Size	Pack
104188	24mm x 41.1m	14
104189	36mm x 41.1m	10

3M 101E Value Masking Tape

General purpose masking tape. Ideal for paint masking, but also bundling, sealing, attaching, and other applications up to a temperature of 60°C for one hour.

- General purpose masking tape
- Reliable paint masking
- Easy to write on for labelling
- Also use for temporary fixing
- Operating temperature range up to 60°C



Product No	Size	Pack
2214-25	24mm	36
2214-38	36mm	24
2214-50	48mm	24

Duck Tape Original

- Ideal for hundreds of uses around the home, garage and garden
- High strength adhesive – sticks firmly to most surfaces
- Strong
- Waterproof
- Seals
- Reinforces
- Protects
- Binds



Product No	Colour	Size	Pack
211109	Black	50mm x 25m	6
211116	Black	50mm x 50m	6
211111	Silver	50mm x 25m	6
211112	Silver	50mm x 50m	6
211115	Silver	50mm x 50m 2 Pack	6
211117	White	50mm x 25m	6

Duck Tape Ultimate

- Ideal for thousands of repairs around the home and garden, at work or at leisure
- 50% stronger than most cloth tapes
- 100% waterproof
- Triple layer technology means 3 high performance layers are fused together to create a heavy duty tape
- Sticks to most surfaces



Product No	Colour	Size	Pack
232152	Black	50mm x 25m	6
232153	Silver	50mm x 25m	6
232160	White	50mm x 25m	6
222150	Clear	50mm x 20m	6

Trade 20

- Prevents brushes drying out when not in use
- Designed to hold up to 20 brushes
- Stores brushes safely
- Maintains brushes in good condition
- Saves clean-up time
- Suitable for use with synthetic filament brushes
- For use with oil based paints only



Product No	Pack
BM120-3	3

Trade 4+

- Prevents brushes drying out when not in use
- Designed to hold up to 4 brushes
- Stores brushes safely
- Maintains brushes in good condition
- Saves clean-up time
- Suitable for use with synthetic filament brushes
- For use with oil based paints only
- Manufactured from robust plastic



Product No	Pack
BM110-6	10

Fluid

- Replacement fluid to maintain the vapour-charged atmosphere in the Trade 20



Product No	Size	Pack
BM130-18	250ml	18

Vapour Mate

- Replacement vaporiser panels for the Trade 4+
- Supplied in a counter display box



Product No	Pack
BM114-10	10

Service Pack

- Kit comprising of dripmat, vaporizing panel and four brush clips for the Trade 20



Product No	Pack
134	10



Our Trade 20 and Trade 4+ are perfect for storing wet gloss and varnish paint brushes.

Using a unique vapour system, they keep brushes soft and pliable – ready for immediate re-use hours, days or even months later.

To find your nearest stockist visit www.brushmate.co.uk



Petersons[®]

...for PAINTING PERFECTION

Petersons has been established as a leader in the painting and decorating industry by offering a concise range of high-quality tools and equipment, catering to the needs of paint stockists - all unified under a single brand. Our commitment is centred on delivering high-quality products in well-designed packaging, all at appealing prices. We take pride in our curated compact range, where we have ensured that every product falls under the category of 'fast movers'.

Our dedication to staying ahead in the market is evident through innovation, as we continue to develop new products. This commitment allows us to maintain a cutting-edge position in the industry. Our brand strategy involves categorising our product range into five distinct areas based on consumer types. Furthermore, our product design is crafted to captivate consumers' attention, enhancing their in-store experience and, ultimately, driving more sales for you as the stockist.

We uphold stringent quality control processes to ensure that our products consistently meet the high standards expected by our customers. For added convenience, we offer attractive display stand deals and readily available point-of-sale materials. We encourage you to discuss these opportunities with your dedicated account manager. Partner with Petersons to bring quality, innovation, and consumer appeal to the forefront of your retail space!

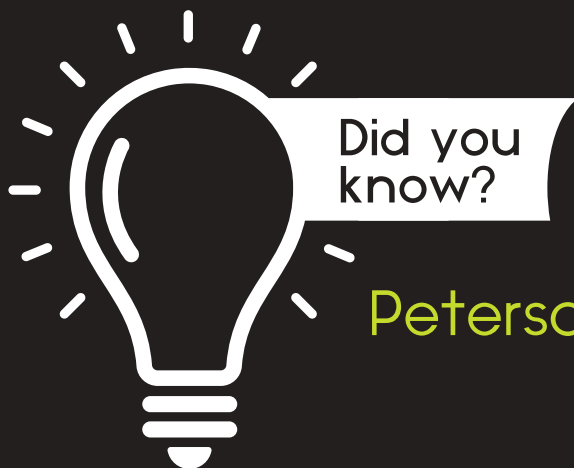

Did you know?

Petersons is a **relay**[®] brand

Above all, we're confident to say that all our products are **for painting perfection** and are guaranteed to provide **100% satisfaction!**



Premier

Premium quality products manufactured to satisfy the demands of the discerning professional and skilled contractor. These products will achieve perfect results and ultimate satisfaction, with many of them being asked for by name in the decorating industry. From bristle paint brushes to line marking paint, this range encompasses all things professional.



Predator



This range contains 'edgy', latest design products for the modern decorator. Current market designs are used throughout this range, ensuring that the Petersons brand maintains its position at the forefront of the market.

Profile

Suited to those who prefer function coupled with form, this range will appeal to younger decorators. This range includes many unique products which appeal to those who like to experiment with something new!



Paragon

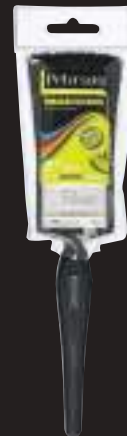

A comprehensive range of products created to meet most painting requirements. These products are appreciated by both the tradesman and the home decorator. This range should form the core of any paint suppliers' product offering, as it contains all the basic requirements of decorating tools and some sundries.

Praxis

This range offers good quality yet economical products for the decorator and DIY enthusiast alike. The Praxis range also includes many transformed and modernised versions of traditional decorating products, which will appeal to this consumer type.



PREMIER



[pri-meer, -myeer, pree-meer]
 Adjective
 First in rank; chief; leading.

Premium quality products manufactured to satisfy the demands of the discerning professional and skilled contractor. These products will achieve perfect results and ultimate satisfaction, with many of them being asked for by name in the decorating industry. From bristle paint brushes to line marking paint, this range encompasses all things professional.

Premier Synthetic Paint Brush



- 100% synthetic SRT filament filling to provide a smooth finish
- Extra thick stock holds a lot of paint
- Long length out gives extra workability
- Untreated wooden handle absorbs excess moisture from hands when in use
- Stainless steel ferrule resists rusting
- Use with water and oil-based coatings
- Packaged in re-usable cardboard packaging to help keep its shape

Product No	Size	Pack
PET401257	1"	12
PET401264	1.5"	12
PET401271	2"	12
PET401288	2.5"	12
PET401295	3"	6

Premier Blended Paint Brush



- Bristle and synthetic mix filling provides a smooth finish and easy clean-up
- Extra thick stock holds a lot of paint
- Long length out gives extra workability
- Untreated wooden handle absorbs excess moisture from hands when in use
- Stainless steel ferrule resists rusting
- Recommended for use with oil-based coatings
- Packaged in re-usable cardboard packaging to help keep its shape

Product No	Size	Pack
PET401219	1"	12
PET401226	1.5"	12
PET401233	2"	12
PET402797	2.5"	12
PET401240	3"	6

Premier Wall Brush

- Synthetic filament provides a smooth finish
- Extra thick stock holds a lot of paint
- Suitable for use in all paint applications
- Untreated wooden handle absorbs excess moisture from hands when in use
- Stainless steel ferrule resists rusting
- Use with water and oil-based coatings
- Packaged in re-usable cardboard packaging to help keep its shape



Product No	Size	Pack
PET407426	6"	12

Premier Tools

- Stainless steel blade resists rusting and is easy to clean
- Full scale tang for the most heavy duty applications
- Sealed hardwood handle
- High quality product



Scraper

Product No	Size	Pack
PET950603	1"	6
PET950610	2"	6
PET950627	3"	6
PET950634	4"	6

Filling Knife

Product No	Size	Pack
PET950658	2"	6
PET950665	3"	6

Premier Cage Format Roller Frame

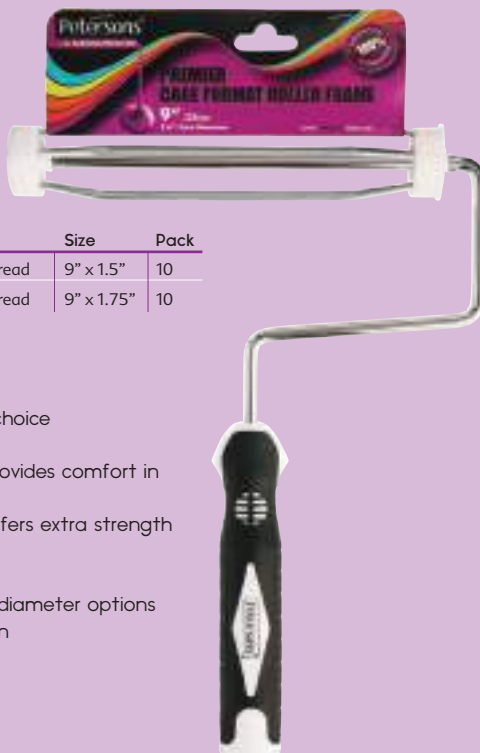

Product No	Type	Size	Pack
PET401912	Screw Thread	9" x 1.5"	10
PET401929	Screw Thread	9" x 1.75"	10

- The professionals' choice
- Threaded handle
- Soft grip handle provides comfort in use
- 8mm wire shank offers extra strength and durability
- 4mm wire cage
- 1.5" and 1.75" cage diameter options
- Robust construction

Premier Heavy Duty Mini Sleeve

- Woven nylon fabric
- Thermalbonded construction reduces fabric shed
- Particularly suited for heavy duty applications
- Perfect for coating steelwork and applying 2-pack coatings



Product No	Pile	Size	Pack
PET401684	Long	4"	10

Premier Roller Sleeve

- Polyamide fabric – offering a superior finish
- Thermalbonded construction reduces fabric shed
- Holds a large volume of paint
- Distinctive white and purple fabric for easy identification after use, resulting in repeat sales
- Exceptional paint pick up and finish
- For use with all paint types
- Choice of 3 nap lengths to suit all applications
- Exceptional value
- Distinctive cardboard keeper packaging for visual attraction and easy identification in store and sleeve storage after use

Product No	Pile	Size	Pack
PET407600	Medium	9" x 1.5"	10
PET407617	Medium	9" x 1.75"	10
PET407624	Medium	12" x 1.75"	10
PET407631	Long	9" x 1.5"	10
PET407648	Long	9" x 1.75"	10
PET407655	Extra Long	9" x 1.5"	10
PET407662	Extra Long	9" x 1.75"	10
PET407679	Extra Long	12" x 1.75"	10



Premier Glossing Roller Sleeve

- Wool blend woven fabric – for best results when applying gloss coatings and varnishes
- Thermalbonded construction reduces fabric shed
- Very short pile eliminates air bubbles in gloss or low viscosity coatings
- Superior results on smooth surfaces
- Distinctive cardboard keeper packaging for visual attraction in store and sleeve storage after use

Product No	Pile	Size	Pack
PET401653	Very Short	9" x 1.5"	10
PET401660	Very Short	9" x 1.75"	10



Premier Glossing Mini Sleeve

- Wool blend woven fabric – for best results when ‘glossing’
- Thermalbonded construction
- Superior results on smooth surfaces



Product No	Pile	Size	Pack
PET401677	Very Short	4"	10

Premier Glossing Mini Sleeve Twin Pack

- Wool blend woven fabric – for best results when ‘glossing’
- Thermalbonded construction
- Superior results on smooth surfaces



Product No	Pile	Size	Pack
PET403824	Very Short	4"	10

Premier Canvas Dust Sheet

- Machine washable
- Heavy duty canvas
- Close weave helps prevent soak through
- Drapes easily
- Tear resistant for increased protection of furniture and flooring
- Includes a Petersons label on the sheet for easy identification after use, resulting in repeat sales



Product No	Size	Pack
PET403763	12' x 12'	10

Premier Chlorinated Rubber Line Marking Paint

- High build
- Very fast drying – touch dry in 10 minutes, through dry in 15 minutes
- Chlorinated rubber/alkyd
- Compatible with most surfaces
- Choice of 5 colours
- Dead matt finish
- Theoretical coverage 3.3m²/litre – 45 metre line at 75mm wide



Product No	Colour	Size	Pack
PET403114	Yellow	5L	2
PET403121	White	5L	2
PET403138	Black	5L	2
PET403145	Blue	5L	2
PET403152	Red	5L	2

PREDATOR



[pred-uh-ter, -tawr]

Noun

A predatory person or thing.

This range contains 'edgy', latest design products for the modern decorator. Current market designs are used throughout this range, ensuring that the Petersons brand maintains its position at the forefront of the market.

Predator Synthetic Paint Brush



- 100% synthetic SRT filament filling to provide a smooth finish
- Long length out gives extra workability
- Untreated wooden handle absorbs excess moisture from hands when in use
- Stainless steel square-edge ferrule resists rusting and provides sharper cutting-in
- Use with water and oil-based coatings
- Packaged in re-usable cardboard packaging to help keep its shape

Product No	Size	Pack
PET401318	1"	12
PET401325	1.5"	12
PET401332	2"	12
PET401349	3"	6

Predator Synthetic Paint Brush 3 Pack



- 3 pack of Predator Synthetic Paint Brush
- Contains 1 x 1", 1 x 1.5" and 1 x 2"

Product No	Size	Pack
PET401356	3 pack	6

Predator *Stealth* Synthetic Oval Paint Brush Set

- Paint brushes with oval profiles carry more paint than paint brushes with traditional shape profiles
- Premium tapered synthetic filaments deliver a controlled, gradual release of paint for a superb finish and neat lines
- The size assortment caters for most needs from covering large areas, to detail and trim work
- This pack includes a 2"/50mm size angle sash stubby handle paint brush which is ideal for use in awkward areas
- Made with rust-resistant steel ferrules, wooden handles from well-managed forests, and fine tapered synthetic filaments
- For use with water or solvent based paints
- Vapour box compatible
- Contains 2 x 1.5", 2 x 2", 1 x 3" and 1 x 2" stubby

Product No	Size	Pack
PET406962	6 pack	10



Predator Block Brush

- Synthetic filament is ideal for use on rough surfaces
- Ideal for timbercare, masonry and pasting
- Suitable for both paint and wallpaper paste
- Plastic body
- Screw in wooden handle
- Bucket clip for ease of use
- Packaged in re-usable cardboard packaging to help keep its shape



Product No	Size	Pack
PET407440	5.5"	12



Predator Synthetic Angle Sash Paint Brush



- 100% synthetic SRT filament filling to provide a smooth finish
- Long length out gives extra workability
- Untreated wooden handle absorbs excess moisture from hands when in use
- Long handle style provides additional balance
- Ideal for cutting-in work
- Use with water and oil-based coatings
- Packaged in re-usable cardboard packaging to help keep its shape

Product No	Size	Pack
PET401301	2"	12
PET402865	2.5"	12

Predator Synthetic Angle Stubby Paint Brush



- 100% synthetic SRT filament filling to provide a smooth finish
- Long length out gives extra workability
- Untreated wooden handle absorbs excess moisture from hands when in use
- Ideal for cutting-in work in awkward spaces and corners
- Use with water and oil-based coatings
- Packaged in re-usable cardboard packaging to help keep its shape

Product No	Size	Pack
PET401363	2"	12

Predator Cotton & Plastic Dust Sheet



- Plastic backing prevents soak through
- Hard wearing 100% virgin cotton twill with laminated plastic backing
- Excellent absorption
- Drapes easily
- Tear resistant for increased protection of furniture and flooring
- Includes a Petersons label on the sheet for easy identification after use, resulting in repeat sales

Product No	Size	Pack
PET402940	12' x 9'	10

Predator Cotton Twill Dust Sheet



- Machine washable
- Hard wearing 100% virgin cotton twill
- Excellent absorption
- Drapes easily
- Tear resistant for increased protection of furniture and flooring
- Includes a Petersons label on the sheet for easy identification after use, resulting in repeat sales

Product No	Size	Pack
PET402933	12' x 9'	10

Q: What's the difference?



A: **PREDATOR SYNTHETIC:** square corner ferrule design provides sharp lines when cutting in!



A: **PREDATOR STEALTH:** oval ferrule design holds a large volume of paint so is great for use on large areas!

...see page 86-87 for details

Predator Microfibre Roller Sleeve



- Microfibre fabric – provides a superior smooth finish
- Thermalbonded construction reduces fabric shed
- Holds an exceptional volume of paint
- Distinctive red and white fabric for easy identification after use, resulting in repeat sales
- Exceptional paint pick up and finish
- For use with emulsion and water based paints on smooth or semi-rough surfaces
- Distinctive cardboard keeper packaging for visual attraction and easy identification in store and sleeve storage after use



Product No	Pile	Size	Pack
PET406221	Medium	9" x 1.5"	10
PET407174	Medium	9" x 1.75"	10
PET406245	Medium	4" x 1.5"	10

Predator Microfibre Mini Sleeve



- Microfibre fabric – provides a superior smooth finish
- Holds an exceptional volume of paint
- Distinctive red and white fabric for easy identification after use, resulting in repeat sales
- Exceptional paint pick up and finish
- For use with emulsion and water based paints on smooth or semi-rough surfaces

Product No	Pile	Size	Pack
PET406252	Medium	4"	10

Predator Headlock Roller Frame & Microfibre Sleeve



- Predator Headlock roller frames feature Headlock technology to make decorating tasks faster and easier
- The patented Headlock technology features a unique cartridge system that locks paint roller sleeves onto the roller frame
- Roller sleeves will not walk off Headlock roller frames
- Soft grip, push-fit handle provides comfort in use
- 1.5" cage diameter
- Microfibre fabric – provides a superior smooth finish
- Thermalbonded construction reduces fabric shed
- Holds an exceptional volume of paint
- Distinctive red and white fabric for easy identification after use, resulting in repeat sales
- Exceptional paint pick up and finish
- For use with emulsion and water based paints on smooth or semi-rough surfaces

Product No	Pile	Size	Pack
PET406269	Medium	9" x 1.5"	10
PET407181	Medium	9" x 1.75"	10
PET406276	Medium	4" x 1.5"	10

PROFILE



[proh-fahyl]

Noun

A typical selection; a sample showing all characteristic parts, relationships, etc.

Suited to those who prefer function coupled with form, this range will appeal to younger decorators. This range includes many unique products which appeal to those who like to experiment with something new!

Profile Synthetic Paint Brush



- Synthetic filament filling provides a smooth finish
- Well filled stock holds plenty of paint
- Good length out
- Plastic and soft grip handle provides comfort in use
- Packaged in plastic wallet packaging

Product No	Size	Pack
PET401448	1"	12
PET405972	1.5"	12
PET401455	2"	12
PET401462	3"	6

Profile Synthetic Paint Brush 3 Pack



- 3 pack of Profile Synthetic Paint Brush
- Contains 1 x 1", 1 x 1.5" and 1 x 2"

Product No	Size	Pack
PET401479	3 pack	6



Profile Cotton Faced Plastic Dust Sheet

- Plastic prevents soak through
- Protects furniture and flooring
- Drapes easily
- Includes a Petersons label on the sheet for easy identification after use, resulting in repeat sales



Product No	Size	Pack
PET402957	10' x 8'	15

We'll help you find the perfect product for your painting project!

PARAGON



[par-uh-gon, -guh n]

Noun

A model or pattern of excellence or of a particular excellence.

A comprehensive range of products created to meet most painting requirements. These products are appreciated by both the tradesman and the home decorator. This range should form the core of any paint suppliers' product offering, as it contains all the basic requirements of decorating tools and some sundries.

Paragon Blended Paint Brush

Paragon Blended Paint Brush 3 Pack



- Bristle and synthetic mix filling provides a smooth finish and easy clean-up
- Well filled stock holds paint better
- Good length out provides extra workability
- Plastic Kaiser style handle offers comfort in use
- Full size range means all requirements are catered for
- Recommended for use with water and oil-based paints
- Packaged in plastic wallet packaging



- 3 pack of Paragon Blended Paint Brush
- Contains 1 x 1", 1 x 1.5" and 1 x 2"

Product No	Size	Pack
PET401370	0.5"	12
PET401387	1"	12
PET401394	1.5"	12
PET401400	2"	12
PET401417	2.5"	6
PET401424	3"	6

Product No	Size	Pack
PET401431	3 pack	6

Paragon Synthetic Paint Brush



- 100% synthetic SRT filament filling to provide a smooth finish and easy clean up
- Long length out gives great workability
- Untreated wooden Kaiser style handle absorbs excess moisture from hands and provides comfort in use
- Stainless steel ferrule resists rusting
- Use with water and oil-based coatings
- Packaged in re-usable cardboard packaging to help keep its shape



Product No	Size	Pack
PET407204	1"	12
PET407211	1.5"	12
PET407228	2"	12
PET407235	3"	12

Paragon 5 Piece Painters Brush Pack

- 100% synthetic SRT filament filling to provide a smooth finish
- Long length out gives great workability
- Untreated wooden handle absorbs excess moisture from hands when in use
- Stainless steel ferrule resists rusting
- Use with water and oil-based coatings



Product No	Size	Pack
PET405965	5 pack	6



Paragon Synthetic Angle Paint Brush



- 100% synthetic SRT filament filling to provide a smooth finish and easy clean up
- Long length out gives great workability
- Untreated wooden Kaiser style handle absorbs excess moisture from hands and provides comfort in use
- Ideal for cutting-in work
- Stainless steel ferrule resists rusting
- Use with water and oil-based coatings
- Packaged in re-usable cardboard packaging to help keep its shape



Product No	Size	Pack
PET407242	0.75"	12
PET407259	1.5"	12
PET407266	2"	12

Paragon Synthetic Angle Sash Paint Brush

- 100% synthetic SRT filament filling to provide a smooth finish and easy clean up
- Long length out gives great workability
- Untreated wooden handle absorbs excess moisture from hands and provides comfort in use
- Ideal for cutting-in work
- Stainless steel ferrule resists rusting
- Use with water and oil-based coatings
- Packaged in re-usable cardboard packaging to help keep its shape



Product No	Size	Pack
PET407280	2"	12

Paragon Synthetic Angle Oval Stubby Paint Brush

- 100% synthetic SRT filament filling to provide a smooth finish and easy clean up
- Oval profile holds more paint than traditional shape profiles
- Long length out gives great workability
- Untreated wooden handle absorbs excess moisture from hands and provides comfort in use
- Ideal for cutting-in work and for use in awkward areas
- Stainless steel ferrule resists rusting
- Use with water and oil-based coatings
- Packaged in re-usable cardboard packaging to help keep its shape



Product No	Size	Pack
PET407273	2"	12

Paragon Synthetic Radiator Brush

- Synthetic filament provides a smooth finish and easy clean up
- Untreated wooden handle absorbs excess moisture from hands and provides comfort in use
- Ideal for use in awkward areas
- Stainless steel ferrule resists rusting
- Use with water and oil-based coatings



Product No	Size	Pack
PET407396	1.5"	8

Paragon Wall Brush

- Synthetic filament provides a smooth finish
- Thick stock holds a lot of paint
- Suitable for use in all paint applications
- Stainless steel ferrule resists rusting
- Use with water and oil-based coatings
- Packaged in re-usable cardboard packaging to help keep its shape



Product No	Size	Pack
PET407433	6"	12

Paragon Synthetic Lining Fitch

- Synthetic filament provides a smooth finish and easy clean up
- Untreated wooden handle absorbs excess moisture from hands and provides comfort in use
- Ideal for detail work
- Stainless steel ferrule resists rusting
- Use with water and oil-based coatings

Product No	Size	Pack
PET407297	0.25"	12
PET407303	0.5"	12
PET407310	0.75"	12
PET407327	1"	12
PET407334	4 Piece Set	10



Paragon Synthetic Round Sash Brush

- Synthetic filament provides a smooth finish and easy clean up
- Untreated wooden handle absorbs excess moisture from hands and provides comfort in use
- Ideal for use on intricate detail, edges and contours
- Stainless steel ferrule resists rusting
- Use with water and oil-based coatings

Product No	Size	Pack
PET407341	15mm	12
PET407358	15mm	12
PET407365	21mm	12
PET407372	25mm	12
PET407389	4 Piece Set	12



Paragon Synthetic Furniture Brush Set

- Synthetic filament provides a smooth finish and easy clean up
- Untreated wooden handle absorbs excess moisture from hands and provides comfort in use
- Ideal for use on intricate details, and when painting furniture
- Stainless steel ferrule resists rusting
- Use with water and oil-based coatings



Product No	Size	Pack
PET407402	Various	10

Paragon Synthetic Touch-Up Paint Brushes

- Synthetic filament provides a smooth finish and easy clean up
- Ideal for use with paint tester pots and for touch-up work
- Stainless steel ferrule resists rusting
- Use with water and oil-based coatings



Product No	Size	Pack
PET407396	1.5"	8

Paragon 5 Piece Artist Brush Set

- Fine camel hair and pure bristle
- Use with all paints, varnishes and glues
- Use for lines, stripes, crafts and touch-up jobs



Product No	Pack
PET402858	12

Paragon Masonry Brush

- Bristle and synthetic mix filling is ideal for masonry coatings
- Robust plastic handle for comfort in use
- Packaged in plastic wallet packaging



Product No	Size	Pack
PET401561	4"	6

Paragon Block Brush

- Synthetic filament is ideal for use on rough surfaces
- Ideal for timbercare, masonry and pasting
- Suitable for both paint and wallpaper paste
- Plastic body
- Bucket clip for ease of use
- Packaged in re-usable cardboard packaging to help keep its shape



Product No	Size	Pack
PET407457	5.5"	12

Paragon Roller Sleeve



- Woven acrylic fabric – offering superior durability
- Thermalbonded construction reduces fabric shed
- Holds a large volume of paint
- Distinctive white and black fabric for easy identification after use, resulting in repeat sales
- Superior paint pick up and distribution
- Choice of 3 nap lengths to suit all applications
- Exceptional value
- Distinctive cardboard keeper packaging for visual attraction and easy identification in store and sleeve storage after use

Product No	Pile	Size	Pack
PET401721	Short	9" x 1.5"	10
PET401738	Short	9" x 1.75"	10
PET401745	Medium	9" x 1.5"	10
PET401752	Medium	9" x 1.75"	10
PET401769	Medium	12" x 1.75"	10
PET401776	Long	9" x 1.5"	10
PET401783	Long	9" x 1.75"	10
PET402872	Long	12" x 1.75"	10

Paragon Jumbo Sleeve

- Woven acrylic fabric – offering superior durability
- Thermalbonded construction reduces fabric shed
- Distinctive white and black fabric for easy identification after use, resulting in repeat sales
- Superior paint pick up and distribution



Product No	Pile	Size	Pack
PET402889	Medium	4" Jumbo	6

Paragon Masonry Roller Sleeve

- Superior coverage and finish quality on masonry surfaces
- Extremely smooth, fast results with all paints
- Low-shed fabric is ideal for rough surfaces, pebble dash and masonry
- 32mm pile length applies coatings evenly to rough surfaces



Product No	Pile	Size	Pack
PET405804	Very Long	9" x 1.5"	12
PET405811	Very Long	9" x 1.75"	12

Paragon Mini Sleeve

- Woven acrylic fabric – offering superior durability
- Thermalbonded construction reduces fabric shed
- Distinctive white and black fabric for easy identification after use, resulting in repeat sales
- Superior paint pick up and distribution



Product No	Pile	Size	Pack
PET401790	Medium	4"	10

Paragon Mini Sleeve Twin Pack

- Woven acrylic fabric – offering superior durability
- Thermalbonded construction reduces fabric shed
- Distinctive white and black fabric for easy identification after use, resulting in repeat sales
- Superior paint pick up and distribution



Product No	Pile	Size	Pack
PET403831	Medium	4"	10

Paragon Foam Mini Sleeve

- Medium density foam for holding a good amount of paint
- Both ends rounded to avoid tramlines
- Fully glued construction
- Good results on smooth surfaces



Product No	Size	Pack
PET401820	4"	10

Paragon Foam Mini Sleeve Twin Pack

- Medium density foam for holding a good amount of paint
- Both ends rounded to avoid tramlines
- Fully glued construction
- Good results on smooth surfaces



Product No	Size	Pack
PET401813	4"	10

Paragon Flocked Foam Mini Sleeve

- High density foam for holding an excellent amount of paint, and overlaid with very short pile flock for a super smooth finish
- Both ends rounded to avoid tramlines
- Fully glued construction
- Excellent results on smooth surfaces



Product No	Size	Pack
PET406306	4"	10

Paragon Cage Format Roller Frame



Product No	Type	Size	Pack
PET401936	Screw Thread	9" x 1.5"	10
PET401943	Screw Thread	9" x 1.75"	10

- The contractors' choice
- Threaded handle
- Soft grip handle provides comfort in use
- 8mm wire shank offers extra strength and durability
- 4mm wire cage
- 1.5" and 1.75" cage diameter options
- Robust construction

Paragon Mini Frame



Product No	Handle Length	Size	Pack
PET401950	11"	4"	10

- Soft grip push-fit handle for comfort in use
- Accepts standard 4" mini sleeves, including all those in the Petersons range

Paragon Double Arm Frame



- Robust construction
- Lightweight metal reduces user fatigue
- Flat section for easy cleaning
- Easy sleeve change
- For use with 12" sleeves only

Product No	Size	Pack
PET401905	12"	6

Paragon Masonry Roller Set

- Set consists of: 1 no. 9" acrylic long pile roller sleeve, 1 no. 9" Paragon Cage Format Roller Frame, 1 no. 4" Paragon Masonry Brush and 1 no. 9" plastic paint tray
- Sturdy paint tray design
- Long pile sleeve is ideal for rough masonry
- Robust plastic and soft grip roller frame handle for comfort in use
- With innovative heat-seal packaging



Product No	Pack
PET406283	12

Paragon Polyacrylic 9" Roller Set

- Set consists of: 2 no. Paragon 9" Medium Pile Roller Sleeves, 1 no. Paragon Cage Format Roller Frame and 1 no. plastic paint tray
- With sturdy tray design and heat-seal packaging



Product No	Pack
PET401981	12



Paragon 12 Piece Painting Set

- Set contains: 9" paint tray, 9" roller frame, 9" polyacrylic roller sleeve x 2, 4" roller frame, 4" polyacrylic roller sleeve x 4, 4" foam roller sleeve x 2, 2" synthetic paint brush
- With sturdy tray design and heat-seal packaging



Product No	Pack
PET407198	12



Paragon Polyacrylic 4" Roller Set

- Available in 2 sleeve or 6 sleeve variants
- Set consists of: Paragon Mini Sleeves, 1 no. Paragon Mini Frame, and 1 no. 4" plastic paint tray



Product No	Type	Pack
PET401998	2 sleeve	12
PET406290	6 sleeve	12

Paragon Foam 4" Roller Set

- Set consists of: 2 no. Paragon Foam Mini Roller Sleeves, 1 no. Paragon Mini Frame and 1 no. 4" plastic paint tray



Product No	Pack
PET402001	12

Paragon Foam & Polyacrylic 17 Piece Roller Set

- Set consists of: 10 no. Paragon Mini Sleeves, 5 no. Paragon Foam Mini Sleeves, 1 no. 11" plastic handle mini frame and 1 no. 22" plastic handle mini frame



Product No	Pack
PET404661	12

Paragon Paint Kettle

- Robust white plastic
- Rounded lip for clean paint removal
- Wire handle with indentation for bucket hook
- Stackable
- Full colour label
- Two size options and lids available



Product No	Size	Pack
PET402469	1L	10
PET402476	1L Lid	10
PET402483	2.5L	10
PET402490	2.5L Lid	10

Paragon Paint Tray

- Four size options for all applications
- Manufactured in strong, robust plastic
- Designs include a pouring lip



Product No	Size	Pack
PET402506	4"	10
PET402513	9"	10
PET405958	11"	10
PET402520	15"	10

Paragon Paint Scuttle

- Manufactured in strong, robust plastic
- Capacity gradations included for easy measuring
- Strong steel handle
- 2.5L and 5L fit up to 4" size sleeves, 10L fits up to 9" size sleeves, 15L fits up to 15" size sleeves and 25L fits up to 18" size sleeves



Product No	Size	Pack
PET403251	2.5L	10
PET405705	5L	10
PET402438	10L	10
PET402537	15L	10
PET403794	25L	10

Paragon Pin Lock Roller Pole

- Pin lock mechanism for stability in use
- Robust fiberglass and aluminium construction
- Durable threaded tip
- Available in the most popular size for trade use

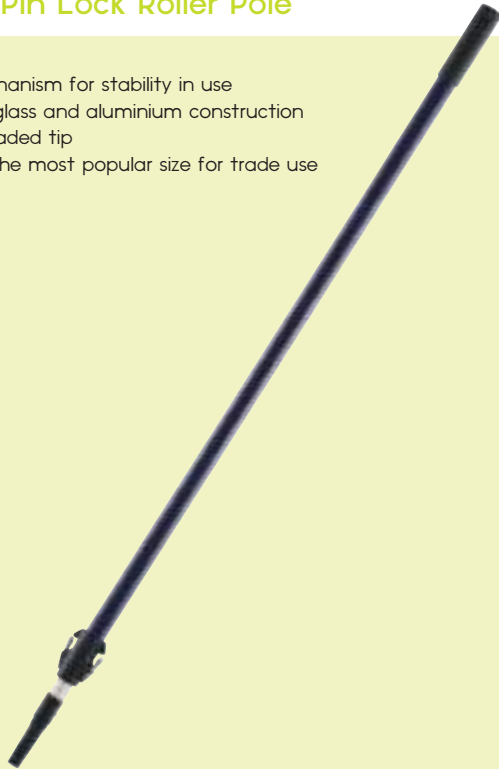

Product No	Size	Pack
PET402049	1.2-2.4m	12

Paragon Twist Lock Roller Pole

- Twist lock mechanism
- Lightweight construction to reduce user fatigue
- Threaded tip with additional push fit adaptor
- Used by DIY and trade



Product No	Size	Pack
PET402063	1.0-2.0m	24

Paragon Tools

- Comfortable soft grip handle
- Stainless steel blade resists rusting and is easy to clean
- Robust construction for all applications
- Virtually indestructible
- Full size range



Scraper

Product No	Size	Pack
PET402964	1"	6
PET402971	2"	6
PET402988	3"	6
PET402995	4"	6

Filling Knife

Product No	Size	Pack
PET403008	1"	6
PET403015	2"	6
PET403022	3"	6
PET403039	4"	6

Paragon 4 Piece Filling Blade Set

- 4 blade set – 1 each 5cm, 8cm, 10cm and 12cm for a wide variety of uses
- Recommended for use with surface fillers
- Flexible stainless steel blade
- Produces a smooth finish
- Plastic grip on one edge ensures access to awkward areas



Product No	Pack
PET402216	12

Paragon Steel Wool 3 Roll

- 3 handy rolls per pack especially designed for the DIY market
- Designed for cleaning and polishing metal, glass and wooden surfaces



Product No	Grade	Weight	Pack
PET407099	Mixed	20g	36

Paragon Steel Wool 8 Pad

- Pad-format is particularly practical and ready for use



Product No	Grade	Weight	Pack
PET407068	Fine / 0	20g	48
PET407075	Medium / 1	20g	48
PET407082	Coarse / 3	20g	48

Paragon Steel Wool Roll

- Versatile product for sanding, polishing and cleaning various surfaces such as wood, metal, plastic and stone
- Handy pack for the tool box



Product No	Grade	Weight	Pack
PET407006	Super Fine / 0000	225g	24
PET407013	Very Fine / 000	225g	24
PET407020	Extra Fine / 00	225g	24
PET407037	Fine / 0	225g	24
PET407044	Medium / 1	225g	24
PET407051	Coarse / 3	225g	24

Paragon Painters Gloves

- Lightweight glove
- With polyurethane coating on fingers and palm
- Tight fitting to give maximum dexterity for the most tactile of applications
- Provide protection against minor cuts and abrasions on the palm and fingers
- Avoid leaving fingerprints on surfaces



Product No	Size	Pack
PET403800	Medium	12
PET403817	Large	12

Paragon Washi Masking Tape

- Special rice paper (washi) tape
- For razor-sharp lines
- Suitable for use on most surfaces
- No paint bleed
- Provides sharp paint lines
- No glue residue left on the surface after use
- UV-proof for up to 6 months
- Suitable for indoor and outdoor use
- 48m length rolls



Product No	Size	Pack
PET407693	24mm	36
PET407709	36mm	24
PET407716	48mm	24

Paragon Low Tack Washi Masking Tape

- Special rice paper (washi) tape
- For delicate and sensitive surfaces
- Low tack for sensitive surfaces such as fresh paint and wallpaper
- No paint bleed
- Provides sharp paint lines
- No glue residue left on the surface after use
- Suitable for indoor use up to 4 months
- 48m length rolls



Product No	Size	Pack
PET407730	24mm	36
PET407747	36mm	24
PET407754	48mm	24

Paragon Masking Tape

- High quality universal paper masking tape for efficient painting
- With double latex impregnation
- No glue residue left on the surface for up to 24 hours after use
- Suitable for indoor and outdoor use
- 48m length rolls



Product No	Size	Pack
PET407778	24mm	36
PET407785	36mm	24
PET407792	48mm	24

Paragon Taped Masking Paper

- Masking paper pre-taped with Paragon Masking Tape
- Ideal for quickly and easily masking small surfaces such as windowsills or skirting boards
- Clean removable up to 24 hours
- 20m length rolls



Product No	Size	Pack
PET407846	180mm	75
PET407853	300mm	25

Paragon Taped Masking Film

- Static masking film pre-taped with Paragon Masking Tape
- Ideal for quickly and easily masking large or small surfaces
- Suitable for indoor and outdoor use
- Clean removable up to 24 hours



Product No	Size	Pack
PET407808	550mm x 33m	60
PET407815	2700mm x 20m	20

Paragon Masking Dispenser

- Fits all sizes of Petersons Paragon Taped Masking Film and Paragon Taped Masking Paper
- Ideal for quickly covering and masking large surfaces
- Includes an integrated cutter
- Reusable



Product No	Size	Pack
PET407822	550mm	10
PET407839	1100mm	10

Paragon Masking Film

- Self-adhesive PE film for protecting walls, windows, carpets and floors
- Also suitable for protecting materials during construction or transport
- Clean removable up to 4 weeks
- Resistant to water, mechanical damage and many chemicals
- UV-proof
- 100m length roll



Product No	Size	Pack
PET407860	500mm	6

Paragon Cotton Twill Dust Sheet

- Protects furniture and flooring
- Machine washable
- Hard wearing 100% virgin cotton twill
- Excellent absorption
- Drapes easily
- Includes a Petersons label on the sheet for easy identification after use, resulting in repeat sales



Product No	Size	Pack
PET402896	12' x 9'	10
PET402902	12' x 9' 2 Pack	10
PET402919	12' x 12'	10
PET402926	24' x 3'	10

Paragon Flexible Decorators Caulk

- Highly flexible solvent-free sealant
- For internal and external use
- Ideal for sealing around window frames, architraves, cornices, PVC profile trim and cladding or sealing cracks and gaps in brickworks, stone, concrete and between skirting boards and walls
- Can be used as an adhesive for bonding polystyrene
- Each cartridge contains sufficient to cover approximately 11 metres of a 6mm x 6mm joint, excluding wastage



BEST SELLER

Paragon Lightweight Filler

- One component lightweight decorators filler
- Specifically developed for filling holes in plaster, wood, brick, stone, wallboard and concrete
- For internal and external use
- Ideal for filling hairline cracks, nail heads, small and large holes
- Dries quickly to give a smooth, permanent finish
- Dries white
- Can be decorated over in 15 minutes



Product No	Size	Pack
PET403862	380ml	12

Product No	Size	Pack
PET403879	500ml	12
PET403886	1L	6

Paragon Polyurethane Floor Paint



- A single pack general purpose polyurethane alkyd floor paint
- Mid sheen finish
- For application to internal concrete floors subject to light or medium traffic
- Apply by brush or roller
- Theoretical coverage 14m²/litre

Product No	Colour	Size	Pack
PET402803	Mid Grey	5L	2
PET402810	Tile Red	5L	2

Paragon White Spirit



- Petroleum solvent, ideal as a thinner for paint
- Also used as a brush and equipment cleaner
- A 'must have' product for all paint and hardware stores

Product No	Size	Pack
PET403046	750ml	12
PET403053	2L	6
PET403060	4L	4



Paragon Synthetic Furniture Brush Set

achieve a flawless
finish on your
next upcycling
project



...see page 97 for details

PRAXIS



[prak-sis]

Noun

Practice, as distinguished from theory; application or use, as of knowledge or skills.

This range offers good quality yet economical products for the decorator and DIY enthusiast alike. The Praxis range also includes many transformed and modernised versions of traditional decorating products, which will appeal to this consumer type.

Praxis Synthetic Paint Brush

Praxis Synthetic Paint Brush Multi-Pack



- Synthetic filament provides a smooth finish
- Suitable for use in all paint applications
- Comfortable shaped handle for ease of use
- Available in cost-saving multi-packs
- Packaged in plastic wallet packaging



Product No	Size	Pack
PET401486	1"	12
PET401493	1.5"	12
PET401509	2"	12
PET401516	2.5"	6
PET401523	3"	6
PET401530	4"	6

- 5 pack contains: 1 x 0.5", 1 x 1", 1 x 1.5" and 2 x 2"
- 10 pack contains: 2 x 0.5", 2 x 1", 3 x 1.5", 2 x 2" and 1 x 3"

Product No	Size	Pack
PET401547	5 pack	6
PET401554	10 pack	6

Praxis Wall Brush

- Synthetic filament provides a smooth finish
- Suitable for use in all paint applications
- Comfortable shaped handle for ease of use
- Packaged in plastic wallet packaging



Product No	Size	Pack
PET403787	6"	6

Praxis Block Brush

- Pure lily bristle ideal for use on rough masonry surfaces
- Plastic body
- Screw in handle
- Bucket clip for ease of use



Product No	Size	Pack
PET401585	4.75"	12

Praxis Fence Brush

- Long synthetic filament for extra workability on fence panels
- Plastic body
- Screw in handle
- Bucket clip for ease of use



Product No	Size	Pack
PET401592	4"	12

Praxis Edge Trimmer

- Innovative tool to help the DIY painter achieve a professional finish
- Ideal for precision painting at wall/wall and wall/ceiling junctions
- Plastic guide wheels follow contour of adjoining surface for easy cutting-in
- Flocked pad for all paint types
- Simple and effective
- Replacement pad available

Product No	Type	Pack
PET402087	Trimmer	10
PET402094	Replacement Pad	6



Praxis Roller Sleeve



- Knitted polyester fabric – for good results on smooth surfaces
- Thermalbonded construction reduces fabric shed
- Good paint pick-up and distribution
- Choice of 2 nap lengths to suit most applications
- Exceptional value
- Packaging enables product to be displayed in store by hanging or on a shelf

Product No	Pile	Size	Pack
PET401837	Medium	9" x 1.5"	10
PET401844	Medium	9" x 1.75"	10
PET401851	Medium	12" x 1.75"	10
PET401868	Long	9" x 1.5"	10
PET401875	Long	9" x 1.75"	10

Praxis Mini Sleeve



- Knitted polyester fabric – for good results on smooth surfaces
- Thermalbonded construction reduces fabric shed
- Good paint pick-up and distribution
- Exceptional value

Product No	Pile	Size	Pack
PET401899	Medium	4"	10

Praxis Mini Sleeve Twin Pack



- Knitted polyester fabric – for good results on smooth surfaces
- Thermalbonded construction reduces fabric shed
- Good paint pick-up and distribution
- Exceptional value

Product No	Pile	Size	Pack
PET401882	Medium	4"	10

Praxis Polyester Combi Set

- Knitted polyester fabric
 - for good results on smooth surfaces
- Thermalbonded construction reduces fabric shed
- Good paint pick-up and distribution
- Exceptional value
- Plastic push-fit handle for comfort in use
- Handle length particularly useful for reaching awkward areas



Product No	Size	Pack
PET403848	4"	6

Praxis Foam & Polyester Combi Set

- Knitted polyester fabric and medium density foam sleeves both provide good results on smooth surfaces
- Good paint pick-up and distribution
- Exceptional value
- Plastic push-fit handle for comfort in use
- Handle length particularly useful for reaching awkward areas



Product No	Size	Pack
PET403855	4"	6

Praxis Cage Format Roller Frame

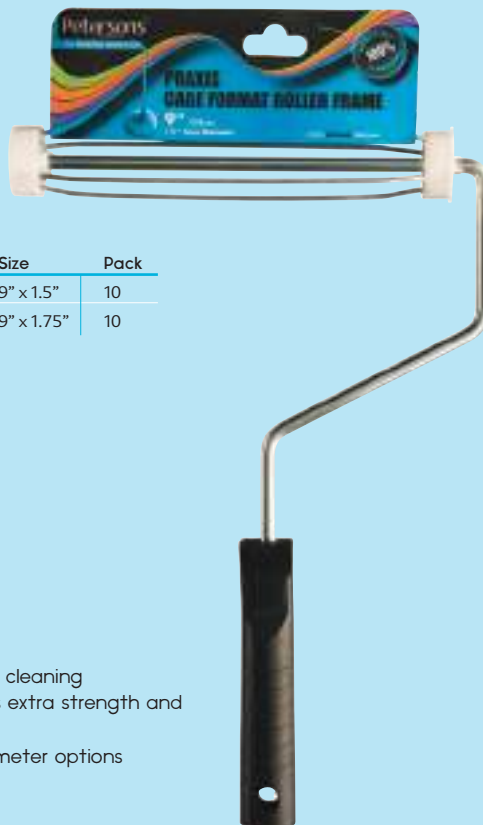

Product No	Type	Size	Pack
PET402735	Push Fit	9" x 1.5"	10
PET402827	Push Fit	9" x 1.75"	10

- The DIY choice
- Push-fit handle
- Plastic handle for easy cleaning
- 8mm wire shank offers extra strength and durability
- 1.5" and 1.75" cage diameter options
- Robust construction

Praxis Mini Frame



Product No	Handle Length	Size	Pack
PET401967	11"	4"	10
PET401974	22"	4"	10

- Plastic push-fit handle for comfort in use
- Accepts standard 4" mini sleeves, including all those in the Petersons range
- 2 length options available
- 22" length particularly useful for reaching awkward areas

Praxis Polyester 9" Roller Set



Featuring Headlock technology



- Set consists of: 2 no. 9" Praxis Medium Pile Roller Sleeves, 1 no. roller frame with Headlock™ technology, and 1 no. 9" plastic paint tray
- Includes the same great Praxis Roller Sleeve as available separately
- Frame features Headlock™ technology which is a unique cartridge system that locks the paint roller sleeve onto the roller frame
- Roller sleeves will not walk off Headlock™ roller frames
- Sturdy tray design with large paint well
- Unique design stacks neatly together for in-store display



BEST SELLER

Product No	Pack
PET402025	12

Praxis Foam & Polyester 4" Roller Set



- Includes one of each: 4" paint tray, 4" mini frame, 4" polyester mini sleeve, and 4" foam sleeve
- Innovative space saving packaging design
- With heat seal packaging

Product No	Pack
PET402018	36

Praxis Polyester 6 Sleeve Roller Set



- Set consists of: 6 no. 9" medium pile polyester roller sleeves, 1 no. 9" cage format plastic handle roller frame and 1 no. 9" plastic paint tray

Product No	Pack
PET404654	12

Praxis 11 Piece Painting Set



- Set contains: 12' x 9' polythene dust sheet, paint brushes x 3, 4" paint tray, 4" plastic handle mini frame, 4" foam sleeve, 4" polyester sleeve, 9" paint tray, 9" plastic handle roller frame, 9" medium pile polyester sleeve

Product No	Pack
PET402032	12

Praxis Polythene Dust Sheet



- Medium weight
- Multiple uses
- Excellent DIY/handyman product
- Great for protecting furniture
- 3 pack options including value triple pack

Product No	Size	Pack
PET950573	12' x 9'	30
PET950580	12' x 12'	20
PET950597	12' x 9' 3 Pack	10

Praxis Roller Pole

- Durable, untreated wood
- Metal threaded tip for durability
- Plastic end cap

Product No	Size	Pack
PET402070	1.2m	24



Praxis Paperhanging Brush



- 100% pure lily bristle to eliminate damage to wallpaper when smoothing
- Well filled stock
- Good quality
- Plastic handle for easy cleaning

Product No	Size	Pack
PET401646	7"	12

Praxis Pasting Table



- Hardboard top
- Wooden legs
- Wire leg stays
- 1780mm long x 560mm wide

Product No	Pack
HWW	2

Praxis Snap-Off Knife

- Retractable snap-off blade
- Razor sharp for precision cutting
- Pocket size for easy use



Product No	Size	Pack
PET402292	18mm	12

Praxis 3 Piece Scraper Set

- Set includes 1 each 25mm, 40mm, and 60mm scrapers for a wide variety of uses
- Wooden handles
- Flexible stainless steel blades
- Ideal for stripping paint and applying surface fillers



Product No	Pack
PET402209	10

Praxis Cartridge Gun

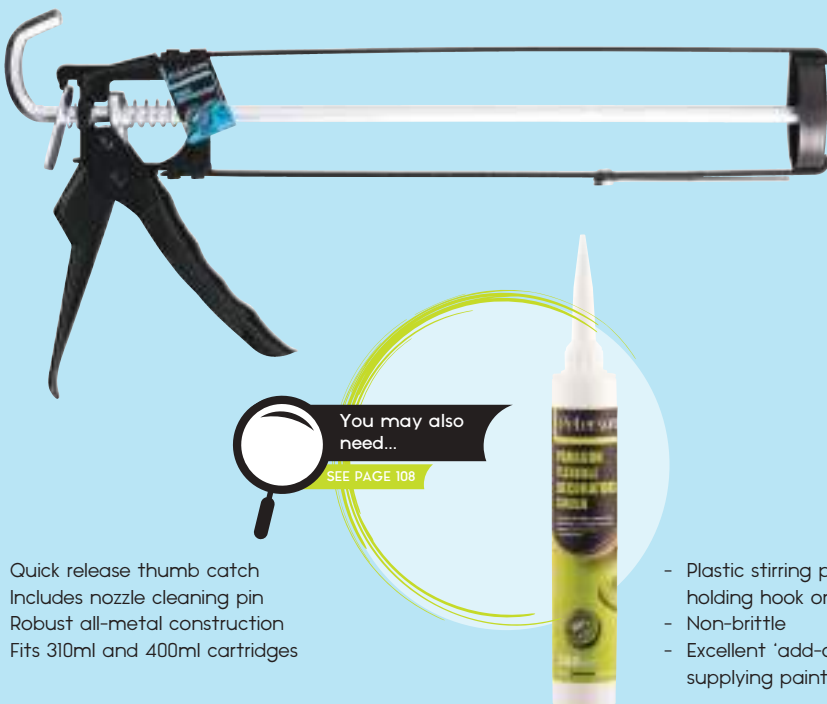

You may also need...
SEE PAGE 108

- Quick release thumb catch
- Includes nozzle cleaning pin
- Robust all-metal construction
- Fits 310ml and 400ml cartridges

Product No	Pack
PET402841	24

Praxis Plastic Paint Stirrer



- Plastic stirring paddle with can opener and holding hook on handle
- Non-brittle
- Excellent 'add-on' sale opportunity when supplying paint

Product No	Size	Pack
739	30cm	50

Display Solutions

- Merchandising
- Category Management
- Profit Generation
- Stock Cleanse Options
- Opening Offer

Petersons can provide display stands and stocking options tailored for your store! Contact us for details or if you wish to discuss with your account manager.





**USE PREDATOR
STEALTH...
IT'S YOUR SECRET
WEAPON FOR
PAINTING
PERFECTION!**

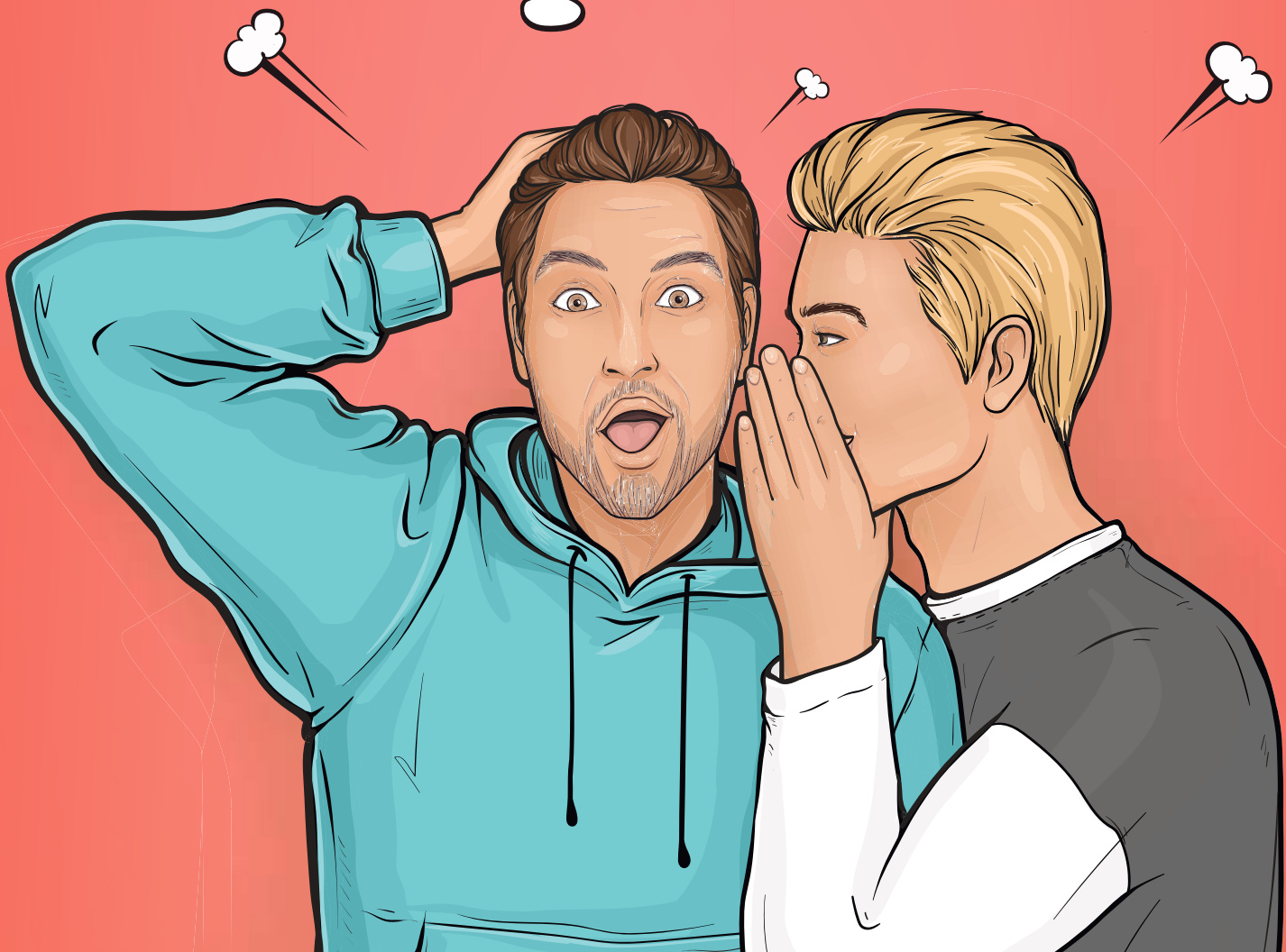

BEYOND PERFECTION

You're committed to being the best of the best. **Series X[®]** puts ultimate all-round performance in the palm of your hand.



MAVERICK[®]

AVAILABLE NOW

maverickpro.com

@beamaverickpro    



SERIES X



with
Memex
advanced
filaments



BEYOND PERFECTION

Advanced in every way

- THE NEATEST EDGE
- THE FINEST FINISH
- LASTING SHAPE RETENTION

SKU	DESCRIPTION	PACK QTY	BARCODE
00101	SERIES X 1.0" S-Type Paint Brush	8	5053521001013
00102	SERIES X 1.5" S-Type Paint Brush	8	5053521001020
00103	SERIES X 2" S-Type Paint Brush SRP*	8	5053521001037
00104	SERIES X 2.5" S-Type Paint Brush SRP*	8	5053521001044
00105	SERIES X 3" S-Type Paint Brush	8	5053521001051
00133	SERIES X 2" A-Type Stubby Paint Brush SRP*	8	5053521001334
00190	SERIES X Paint Brush Set 3PC (1.5", 2", 2.5") SRP*	8	5053521001907

*Shelf-ready merchandising unit included

Scan to watch the SERIES X video:



MAVERICK



SERIES S



with
Twista
filament
technology



PUSH LIMITS

Filaments with a twist

- GREATER COVERAGE
- MORE ACCURACY AND CONTROL
- EXTRA COMFORT

SKU	DESCRIPTION	PACK QTY	BARCODE
00201	SERIES S 1" S Type Paint Brush	8	5053521002010
00202	SERIES S 1.5" S Type Paint Brush	8	5053521002027
00203	SERIES S 2" S Type Paint Brush SRP*	8	5053521002034
00204	SERIES S 2.5" S Type Paint Brush SRP*	8	5053521002041
00205	SERIES S 3" S Type Paint Brush	8	5053521002058
00290	SERIES S Paint Brush Set 3PC (1.5", 2", 2.5") SRP*	8	5053521002904

*Shelf-ready merchandising unit included

Scan to watch the SERIES S video:



MAVERICK

FreeForm Brush



No more cramped hands!
With a Grip-Free Paintbrush, the only thing you'll feel is accomplishment.



Experience the Difference

- Greater Control
- Reduced Fatigue
- Unmatched Comfort
- Pain-Free Painting



Grip-Free All-Purpose Flat Paint Brush

- Grip-free design = relaxed muscles
- FreeForm locks to the hand, requiring zero grip pressure
- No more cramped hands!
- Greatly reduced fatigue
- Greater control
- Unmatched comfort
- Enjoy a better painting experience
- Stiff bristles
- For semi-rough and rough surfaces
- 60% Polyester solid round tapered / 40% Polyester cross-section tapered filament



Product No	Size	Pack
GF015F-AP	1.5 inch	6
GF020F-AP	2 inch	6
GF025F-AP	2.5 inch	6
GF030F-AP	3 inch	6

Grip-Free All-Purpose Angle Paint Brush

- Grip-free design = relaxed muscles
- FreeForm locks to the hand, requiring zero grip pressure
- No more cramped hands!
- Greatly reduced fatigue
- Greater control
- Unmatched comfort
- Enjoy a better painting experience
- Stiff bristles
- For semi-rough and rough surfaces
- 60% Polyester solid round tapered / 40% Polyester cross-section tapered filament



Product No	Size	Pack
GF015A-AP	1.5 inch	6
GF020A-AP	2 inch	6
GF025A-AP	2.5 inch	6
GF030A-AP	3 inch	6

Can & Bottle Opener

- Lifts standard paint can lids and bottle tops
- Supplied in a display bucket of 100 pieces



Product No	Pack
CBO100	1

Spiral Paint Mixer

- Fits all drill chucks for easy mixing
- Mixes most viscous fluids quickly and easily
- All steel heavy-duty construction



Product No	Size	Pack
SM1	50mm dia.	10
SM5	100mm dia.	5

Paint Shield

- Stainless steel edge trim guide
- Straight edge
- 2 size options



Product No	Size	Pack
PS1	24"	10
PS2	12"	10

Extension Brush Holder

- Attaches brushes and tools to extension poles giving extra reach
- Swivel head adjustment
- Secure clamping of tool
- Manufactured from shatterproof plastic



**BEST
SELLER**

Product No	Pack
EBH	10

Swivel Pail Hook

- Holds paint can safely on ladder
- Safe handle retaining clip
- Swivel for left or right hand use
- All chromed metal construction



Product No	Pack
SPH	10

Wallpaper Shears

- Soft grip handles
- 11" long blades



Product No	Pack
WS	5

Rubber Sanding Block

- Solid rubber with steel grippers
- Uses ¼ sheet of sandpaper



Product No	Pack
RB1	10

Hand Sander

- Made from tough, lightweight polypropylene foam
- Stainless steel wire sheet retaining clips
- Padded sanding face
- Soft grip 'D' handle



Product No	Size	Pack
UHS	225 x 83mm	5

Pole Sander

- Swivel head, pole mountable sander for sanding walls and ceilings
- Made from tough, lightweight polypropylene foam
- Stainless steel wire sheet retaining clips
- Padded sanding face

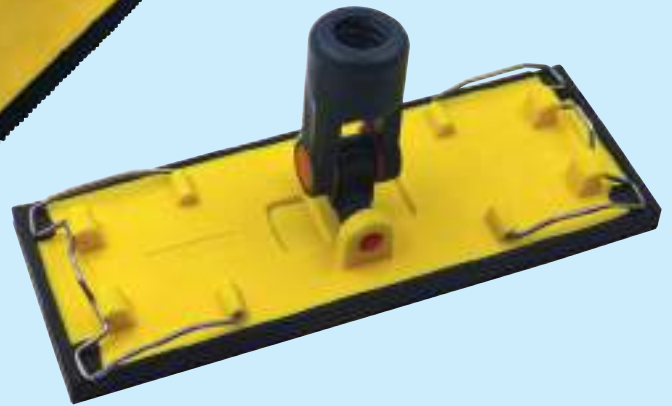

Product No	Size	Pack
UPS	225 x 83mm	5

EZ Paint Pail

- 1.4L capacity
- Soft grip handle
- Design includes magnetic brush holder
- Nestable for compact instore display
- Disposable liners available for quick colour change and easy clean-up



Product No	Type	Pack
PC2	Pail	12
PCL6	Liner 6 Pack	8

Sherlock Roller Frame

- Unique retaining spring prevents roller sleeve 'walking off'
- Easy one-rap sleeve removal
- Fiberglass reinforced nylon cage
- Heavy-duty chrome-plated shank
- Threaded handle



Product No	Size	Pack
R017	9" x 1.5"	6
ER317-9	9" x 1.75"	6

Sherlock Roller Pole

- Thumb-release pin locking device means no slipping
- Hexagonal section aluminium inner pole – no twisting and easy to clean
- Soft grip handle
- Fiberglass outer pole
- Universal zinc diecast threaded tip
- 6" locking increments
- Maintenance kits available



Product No	Size	Pack
R053	1' - 2'	6
R054	2' - 4'	6
R055	4' - 8'	6
R056	6' - 12'	3
R057	8' - 16'	3

Sherlock Maintenance Kit

Product No	Pack
FR950	3

Paperwiz Original 3-In-1 Tool

- Paperwiz makes applying wallpaper and borders fast, easy and trouble-free with three functions:
- Smooth - for air pockets and imperfections
 - Seam - effortlessly seal and set seams
 - Trim - glides for a neat trim finish.
- Replaces a smoother, seam roller, and trim guide
 - Transparent material for superior surface visibility
 - Cut resistant material combats trim knife damage
 - Double bevel edge design prevents interference
 - Avoid stretching scratching, tearing and split seams



Product No	Pack
69500	12

Easy Seam Wallpaper Seam Roller

- For smoothing seams on flat or textured wallpaper
- Foam roller head
- Push-fit handle for use with an extension pole



Product No	Pack
63401	6

Seal & Save

- Rollers stay fresh for hours, days, even weeks!
- Simply insert paint roller sleeve or brush and tightly seal
- Extend the life of roller sleeves and brushes
- Save time and effort with fewer clean ups
- Less mess and easy to use and reuse
- Fits up to 9" roller sleeves



Product No	Pack
73501	12

Essentials Paint Can Opener

- Opens paint cans quickly and easily
- Extra functionality includes use as a bottle opener, nail pull, and a basic screw driver head
- Cut from strong steel
- Great pocket size makes this an essential tool for professional painters and a useful tool for around the home



Product No	Pack
73510	30

Essentials Push-Fit Pole Adaptor

- Converts existing screw threaded extension pole for use with push on paint roller frames
- Tough and hard-wearing

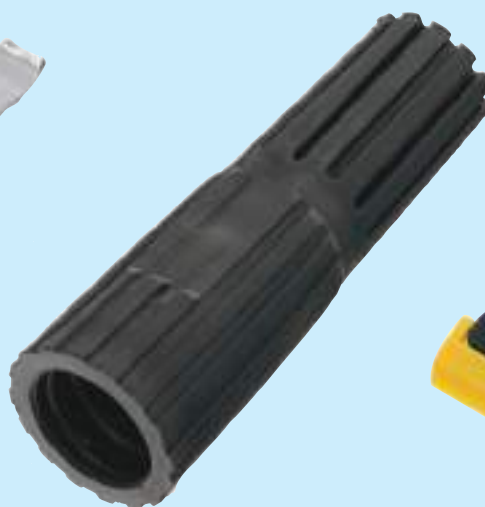

Product No	Pack
76300	12

Essentials Window Scraper

- Scrape paint, stickers, adhesive residue and more
- Suitable for glass and tiles
- Compatible with 60mm blades
- Safety cap included



Product No	Pack
53350	10

Essentials 4 Row Wire Brush

- Fine wire for loose paint and rust removal
- 4 rows of wire for more surface coverage
- Hanging hole for convenient storage



Product No	Pack
73390	8

Essentials Sanding Sponges

- Includes 2no. fine grit blocks, 2no. medium grit blocks, and 2no. coarse grit blocks
- Suitable for wet or dry sanding of wood, paint, metal, fibreglass, plastic and drywall materials
- Foam sponge base is great for sanding contours, irregular shapes or flat surfaces



Product No	Pack
74300	6

Essentials Assorted Sandpaper Sheets

- Assorted pack of sand-paper for decorating, DIY, and general use
- 229mm x 140mm sheets
- Pack includes 10 sheets: 3x fine grit, 4x medium grit, and 3x coarse grit
- Suitable for use on wood, paint, varnish and plaster



Product No	Pack
74200	20

Paintwiz Scuttle Liners

- Less mess: never wash another paint scuttle again!
- Save time: cuts cleanup time to one minute without water!
- Quick changes: swap liners when working with multiple colours
- Handy for breaks: tighten tie-tape to keep paint and tools fresh
- Longer life: keeps scuttle pristine and extends its useful life
- Less waste: snip a corner and squeeze excess paint back into its container
- Water kind: waterless cleanup eliminates paint-laden drain water
- Versatile: suitable for water and solvent-based paints



Product No	Size	Pack
73334	5L 8 Pack	10
73335	10L 8 Pack	10
73336	15L 8 Pack	10
73337	25L 8 Pack	10



Paintwiz Kettle Liners

- Less mess: never wash another paint kettle again!
- Save time: cuts cleanup time to one minute without water!
- Quick changes: swap liners when working with multiple colours
- Handy for breaks: tighten tie-tape to keep paint and tools fresh
- Longer life: keeps kettle pristine and extends its useful life
- Less waste: snip a corner and squeeze excess paint back into its container
- Water kind: waterless cleanup eliminates paint-laden drain water
- Versatile: suitable for water and solvent-based paints



Product No	Size	Pack
73332	2.5L 8 Pack	10





relay.global



HARDWARE 2024

Safety Glass Scraper

- Retractable blade
- Automatic blade lock
- Intermediate blade position prevents blade sliding out when in use
- All metal construction
- Uses standard single edge blades (SEB10)
- Includes 5 spare blades



BEST SELLER

Product No	Pack
GS	10

Glass & Tile Scraper

- 4" wide replaceable blade
- Push-button blade replacement action
- Robust construction in grey plastic
- Soft grip handle
- Replacement blades available (WSB)



Product No	Size	Pack
GTS	4"	10

Mini Glass Scraper

- Handy pocket size
- Uses standard single edge blades (SEB10)
- Open or close with easy push-button lock



Product No	Pack
GSM	10

Carbide Scraper

- Replaceable diamond honed blade
- Extra long life blades last 50 times longer than carbon steel
- Soft grip handle with a metal hammer-end
- Lightweight aluminium body
- Replacement blades available (CB20)



Product No	Size	Pack
CBS20	2"	5

Wallcovering & Flooring Stripper

- Soft grip handle with blade storage
- Light and strong aluminium head
- Includes blade guard
- 30cm long handle
- Replacement blades available (WSB)



Product No	Size	Pack
WPS	2"	5

Retractable Utility Knife

- Heavy duty die cast metal body
- Retractable blade
- 3 cutting positions
- Steel blade slider
- Includes 3 blades
- Powder coated finish
- Replacement blades available (RKB5)



Product No	Pack
SLK	10

Soft Grip Snap Off Knife

- Soft grip and ABS plastic body
- Stainless steel track and blades
- Auto-lock function



Product No	Size	Pack
RK13	9mm	10
RK7	18mm	10

Replacement Blades

Single Edge Blades

Product No	Pack
SEB10	10



Universal Stripper Blades

Product No	Size	Pack
WSB	4"	10



Carbide Blades

Product No	Size	Pack
CB20	2"	5



Utility Knife Blades

Product No	Size	Pack
RKB5	3 notch	10



Caulking Tool

- 3 tools in 1
- Special stainless steel blade to remove old caulk and mastic
- Variable radius mastic smoothing tool
- Integral flat plastic scraper
- Soft grip handle



Product No	Pack
CT31	5

4-In-1 Screwdriver

- Manufactured from high-torque, fibreglass reinforced composite material
- Non-slip, ergonomic grip
- Visible bit storage
- Powerful rare earth 'Neodymium' magnet
- Supplied with 4 specially hardened bits – 2 x flat and 2 x Philips
- Electronic safe
- Heavy duty but lightweight
- Supplied in a counter display carton



Product No	Pack
SD41	10

Driver Cutter Knife

- A superior choice for cutting
- These versatile knives are capable of superior cutting performance!
- Featuring an extra hard blade guide with a tapered tip
- Additional usage as a screw driver or for piercing carton tape when opening boxes is possible
- Produced with a stainless steel blade guide secured to a hardwearing plastic and elastomer casing for improved comfort and control
- The blade is made with premium SK-120 steel
- Supplied pre-loaded with a premium Tajima Razar Blade



Product No	Size	Pack
DC360YB	9mm	10
DC560YB	18mm	10

Dura Cutter Knife

- A superior choice for cutting
- A robust knife capable of superior cutting performance even on demanding jobs, with an extra hard blade guide that delivers more than standard models
- The stainless steel blade guide is secured to a hardwearing plastic and elastomer casing
- The blade is made with premium SK-120 steel
- Supplied pre-loaded with a premium Tajima Razar Blade



Product No	Size	Pack
DC660YB	25mm	10

Quick Back Knife

- An excellent choice for high performance cutting
- With a convenient fin for prying open paint cans, scoring, and piercing carton tape
- The working end of the knife can also be used as a screw driver
- Automatic blade retraction to protect against accidental cuts
- The knife can also switch to standard auto-lock mode, because of an advanced self-retracting system
- Produced with a stainless steel blade guide secured to a hardwearing plastic and rubberised casing
- The blade is made with premium SK-120 steel
- Supplied pre-loaded with a premium Tajima Razar Blade



Product No	Size	Type	Pack
DFC569B	18mm	Knife	10
SETDFC569B	18mm	Knife With Holster	6

Razar Snap-Off Replacement Blades

- An excellent choice for cutting applications such as wallpaper, cartons, cardboard, and film
- Exceptionally smooth and fine quality of cut, because of Japanese style tempering and multi-step sharpening
- To lower cost-per-cut, blades stay sharper for longer making them a wise choice for professionals!
- Produced with SK-120 premium grade steel with a blade thickness of 0.5mm



Product No	Size	Pack
LCB30RBC	9mm 10 Pack	10
LCB50RBC	18mm 10 Pack	10
LCB65RBC	25mm 10 Pack	10



Sweep the floor before you begin mopping, or you'll just smear the dirt.

Anon



GARDAG ...for the home

Soft PVC Broom

- Made with soft PVC bristles and a varnished wooden stock
- Suitable for indoor sweeping of dust and dirt
- The sturdy bracket holds the shaft in place
- The broom width makes it suitable for all types of indoor sweeping



Product No	Type	Size	Pack
GA404425	Broom	11"	12
GA404425A	Assembled	11"	12

Red Stock Broom

- Perfect for sweeping away dirt, sand or debris
- With soft coco bristles in an attractive red stock
- Suitable for use in dry conditions
- The sturdy bracket holds the shaft in place



Product No	Type	Size	Pack
GA404432	Broom	11"	12
GA404432A	Assembled	11"	12

Coco Broom

- Perfect for sweeping away dirt, sand or debris
- With soft coco bristles in a varnished wooden stock
- Suitable for use in dry conditions
- The sturdy bracket holds the shaft in place



Product No	Type	Size	Pack
GA404449	Broom	11"	12
GA404449A	Assembled	11"	12

Bassine Broom

- Bristles made from 100% natural bassine, a long-lasting bristled fibre known for its exceptional durability and strength
- Ideal for tackling tough outdoor surfaces such as decking, paths and patios
- The sturdy bracket holds the shaft in place



Product No	Type	Size	Pack
GA404487	Broom	11"	12
GA404487A	Assembled	11"	12

Deck Scrub

- Makes light work of removing grime, dirt, and mud from decking
- Bristles made from durable bassine and includes a sturdy bracket for holding the shaft in place
- Removes built-up dirt quickly and efficiently



Product No	Type	Size	Pack
GA404524	Broom	9"	12
GA404524A	Assembled	9"	12

PVC Broom

- PVC bristles ensure removal of even the toughest dirt and debris
- Can be used indoors or outdoors and on a variety of surfaces
- The flexible bristles allow it to easily sweep tight corners and narrow areas



Product No	Type	Size	Pack
GA404531	Broom	11"	12
GA404531A	Assembled	11"	12

Black PVC Broom

- Made with high-grade PVC bristles, perfect for heavy-duty tasks
- The generous size head sweeps large areas
- Designed to offer strength and durability



Product No	Type	Size	Pack
GA404548	Broom	13"	12
GA404548A	Assembled	13"	12

Red PVC Yard Broom

- Made with tough, durable PVC bristles for efficient sweeping
- Designed to tackle dirt and debris from large areas
- Ideal for use in the garden, patio, driveways and more



Product No	Type	Size	Pack
GA404555	Broom	10"	12
GA404555A	Assembled	10"	12

Black & White Nylon Yard Broom

- Premium quality materials and high-quality construction
- Made with resilient nylon bristles
- The longer bristles are great for deeper cleaning, while also providing greater surface area coverage
- Designed to last through extensive use, making it the perfect choice for outdoor sweeping



Product No	Type	Size	Pack
GA404562	Broom	13"	12
GA404562A	Assembled	13"	12

Coco Platform Broom

- The natural coco bristles ensure a clean sweep
- Wide broom head helps to sweep large areas quicker



Product No	Type	Size	Pack
GA404456	Broom	18"	12
GA404456A	Assembled	18"	12
GA404463	Broom	24"	12
GA404463A	Assembled	24"	12
GA404470	Broom	36"	12
GA404470A	Assembled	36"	12

Bassine Platform Broom

- Bristles made from 100% natural bassine, a long-lasting bristled fibre known for its exceptional durability and strength
- Ideal for tackling large outdoor surfaces such as decking, paths and patios



Product No	Type	Size	Pack
GA404494	Broom	18"	12
GA404494A	Assembled	18"	12
GA404500	Broom	24"	12
GA404500A	Assembled	24"	12
GA404517	Broom	36"	12
GA404517A	Assembled	36"	12

Black & White PVC Platform Broom

- Heavy-duty PVC bristles for superior strength and versatility
- The wide head gives a perfect balance of rigidity and flexibility, making sweeping easier
- Whether indoors or outdoors, this broom is perfect for use on smooth or uneven surfaces
- Ideal for any sweeping task in the yard or garden



Product No	Type	Size	Pack
GA404579	Broom	18"	12
GA404579A	Assembled	18"	12
GA404586	Broom	24"	12
GA404586A	Assembled	24"	12

Coco Hand Brush

- Perfect for sweeping away dirt and dust from hard-to-reach places
- The natural coco fibre bristles effectively remove dust, dirt and debris without scratching delicate surfaces
- Ideal for smaller tasks such as getting into tight spots or detailed cleaning jobs



Product No | Pack
GA404388 | 24

Bassine Hand Brush

- Cleans dirt quickly and easily
- This medium-stiff brush uses natural bassine fibre bristles for effective cleaning
- The tough bristles are designed to tackle dirt, mud and more
- Ideal for smaller tasks such as getting into tight spots or detailed cleaning jobs



Product No | Pack
GA404395 | 20

Red Handle Bassine Hand Brush

- Cleans dirt quickly and easily
- This medium-stiff brush uses natural bassine fibre bristles for effective cleaning
- The tough bristles are designed to tackle dirt, mud and more
- Ideal for smaller tasks such as getting into tight spots or detailed cleaning jobs

Product No | Pack
GA404401 | 12

Green PVC Hand Brush

- The soft PVC bristles offer a deep clean that won't damage surfaces
- Ideal for smaller tasks such as getting into tight spots or detailed cleaning jobs
- For indoor and outdoor use



Product No | Pack
GA404418 | 24

Wooden Scrubbing Brush

- Perfect for scrubbing away dirt and grime from hard-to-reach places without the need for harsh chemicals
- Traditional style scrubbing brush with a varnished wooden stock
- Ideal for removing mud, moss, and lichen from outdoor surfaces



Product No | Pack
GA404371 | 12

Brooms Display Stand

- Contact us for details on display fill



Yard Broom Clamp



Product No	Pack
YBC	12

Platform Broom Clamp



Product No	Pack
PBC	12

Brush Shaft

Product No	Size	Pack
CBS1965	4'	25
KM104	5'	25



Boot Jack & Scraper

- Robust metal construction
- With bassine filament for easy dirt removal



Product No	Pack
GA404692	3

Infallible Bucket

- Heavy duty bucket
- Calibrated in gallons and litres
- With gripper handle and pourer



Product No	Size	Pack
GA406993	15L	10

Builders Bucket

- Heavy duty builders bucket
- Calibrated in gallons and litres
- With strong metal gripper handle which adds comfort when carrying heavy loads
- With pourer to avoid splashes
- Suitable for use on building sites and around the home
- Durable and easy to clean



Product No	Size	Pack
GA407594	15L	10

Arcade Mail Box

- Secure lock with 2 keys
- Waterproof construction
- Made from galvanized steel
- Viewing window
- Pre-drilled holes for easy installation
- Dimensions 36cm x 37cm x 13.5cm

Product No	Colour	Pack
GA406313	Black	5
GA406320	White	5
GA406337	Green	5
GA406344	Red	5



Concourse Mail Box

- Secure lock with 2 keys
- Waterproof construction
- Made from galvanized steel
- Viewing window
- Pre-drilled holes for easy installation
- Dimensions 32cm x 21.5cm x 8.5cm



Product No	Colour	Pack
GA406351	Grey	5
GA406368	White	5

Atrium Mail Box

- Secure lock with 2 keys
- Waterproof construction
- Made from galvanized steel
- Pre-drilled holes for easy installation
- Dimensions 37cm x 37cm x 10cm



Product No	Colour	Pack
GA408409	Anthracite	5

Piazza Mail Box

- Secure lock with 2 keys
- Robust stainless steel construction
- Pre-drilled holes for easy installation
- Dimensions 36cm x 11.5cm x 31.5cm



Product No	Colour	Pack
GA406467	Stainless Steel	5

Gallery Mail Box

- Secure lock with 2 keys
- All-metal heavy duty weatherproof construction
- Pre-drilled holes for easy installation
- Dimensions 29cm x 13cm x 41cm

Product No	Design	Pack
1	GA406375 Red Rose	4
2	GA406382 White Rose	4
3	GA406399 Gold Rose	4
4	GA406429 Shamrock	4
5	GA406436 Sunflower	4
6	GA407556 Sheepdog	4
7	GA406443 Scottie Dog	4
8	GA406405 Carriage	4
9	GA407549 Sheep	4
10	GA407532 Cockerel	4
11	GA406412 Cow	4
12	GA406450 Plain Black	4
13	GA407525 Plain Cream	4
14	GA407563 Blue Tractor	4
15	GA407570 Red Tractor	4
16	GA407587 Green Tractor	4





9

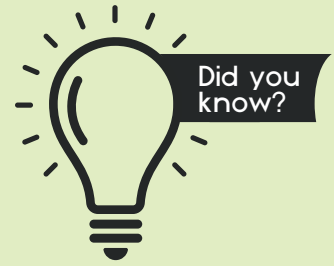

Gardag is a
relay® brand



10



11



12



13



14



15



16

Compost Caddy

- Sturdy metal design
- Ideal for storing food scraps before transferring to an outdoor compost heap or food recycling bin



Product No	Size	Pack
CL405989	5L	1

Wool Mop

Product No	Type	Size	Pack
PXS14J10	Mop	14 Ply	10
CBS1961	Assembled	14 Ply	10
PXS16J10	Mop	16 Ply	10
CBS1962	Assembled	16 Ply	10



Twine Mop



Product No	Type	Size	Pack
CXS14J10	Mop	14 Ply	10
CBS1963	Assembled	14 Ply	10
CXS16J10	Mop	16 Ply	10
CBS1964	Assembled	16 Ply	10

Plastic Mop Bucket



Product No	Size	Pack
CL406764	12L	6

Galvanised Mop Bucket



Product No	Size	Pack
CL404715	12L	2

Galvanised Bucket



Product No	Size	Pack
CL404708	12L	12

YOUR CASTLE, YOUR HOME

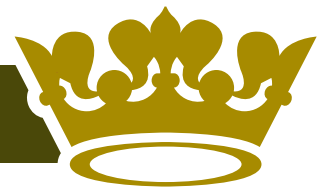

YOUR CASTLE, YOUR HOME



“The objective of cleaning is not just to clean, but to feel happiness living within that environment.

Marie Kondo



castle
living
HOMEWARE



LPG Hose

- Pressure hose designed for propane-butane gas
- Exceptionally resistant to damage caused by contact with hot objects
- Temperature range -10/+50°C
- Safety certificate
- Standard version: outside - orange, inside - black



Product No	Size	Pack
20-001	9mm x 3mm x 50m	1

Stand Version

Product No	Size	Pack
20-680	9mm x 3mm x 60m	1

Acetylene Hose

- Pressure hose designed for acetylene
- Exceptionally resistant to damage caused by contact with hot objects
- Temperature range -15/+50°C
- Safety certificate
- Standard version: outside - red, inside - black



Product No	Size	Pack
20-010	9mm x 3mm x 50m	1

Stand Version

Product No	Size	Pack
20-682	9mm x 3mm x 60m	1

Oxygen Hose

- Pressure hose designed for oxygen
- Exceptionally resistant to damage caused by contact with hot objects
- Temperature range -15/+50°C
- Safety certificate
- Standard version: outside - blue, inside - black



Product No	Size	Pack
20-020	6mm x 3mm x 50m	1

Stand Version

Product No	Size	Pack
20-684	6mm x 3mm x 80m	1

Technical Hose

- PVC hose with textile reinforcement designed for all pesticides, air, light chemicals and food in compliance with the Commission Regulation (EU) No 10/2011 for type A-B-C simulants
- Temperature range -10/+60°C
- Phthalate free colourless version hose



Product No	Size	Pack
20-272	6mm x 2mm x 50m	1
20-273	8mm x 2mm x 50m	1
20-274	10mm x 2mm x 50m	1
20-278	19mm x 3mm x 50m	1
20-280	32mm x 4.5mm x 25m	1

Multipurpose PVC Reinforced Hose

- Pressure hose designed for compressed air, light chemicals and oil-free substances
- Temperature range -10/+60°C
- Safety certificate, food quality certificate
- Colourless version hose



Product No	Size	Pack
20-102N	6mm x 2.5mm x 50m	1
20-103	8mm x 2.5mm x 50m	1
20-105	10mm x 3mm x 50m	1
20-106	12.5mm x 3mm x 50m	1
20-107	16mm x 3.5mm x 50m	1
20-108	19mm x 3.5mm x 50m	1
20-109	25mm x 4.5mm x 50m	1

Stand Version

Product No	Size	Pack
20-670	6mm x 2.5mm x 110m	1
20-671	8mm x 2.5mm x 80m	1
20-672	10mm x 3mm x 50m	1
20-673	12.5mm x 3mm x 40m	1
20-674	16mm x 3.5mm x 30m	1
20-675	19mm x 3.5mm x 30m	1
20-676	25mm x 4.5mm x 20m	1

Multipurpose PVC Hose

- Low-pressure hose designed for compressed air, light chemicals and oil-free substances
- Temperature range -10/+60°C
- Safety certificate, food quality certificate
- Colourless version hose



Product No	Size	Pack
20-400	4mm x 1mm x 50m	1
20-402	6mm x 1.5mm x 50m	1
20-403	8mm x 1.5mm x 50m	1
20-404	10mm x 1.5mm x 50m	1
20-405	12.5mm x 2mm x 50m	1
20-406	16mm x 2mm x 50m	1
20-427	19.5mm x 2.5mm x 50m	1
20-428	25mm x 3mm x 50m	1

Stand Version

Product No	Size	Pack
20-660	4mm x 1mm x 330m	1
20-661	6mm x 1.5mm x 160m	1
20-662	8mm x 1.5mm x 120m	1
20-664	10mm x 1.5mm x 100m	1
20-665	12mm x 2mm x 50m	1
20-666	16mm x 2mm x 50m	1
20-667	19mm x 3mm x 35m	1

Cable Tidy Clips

- Easy to use re-usable hooks designed not to damage or impact on walls
- Use for guiding cables along walls or tables or around computers and other electrical equipment
- Ideal for student halls, rental homes, caravans and other areas where walls need to be kept free from damage caused by nails or screws
- Featuring a heavy-duty adhesive that creates a strong bond to the wall
- Once the clips are not required, they can be removed by simply stretching off the adhesive – leaving the wall undamaged, with no unsightly holes or marks
- Supplied with additional adhesive strips, allowing them to be removed and used again and again



Product No	Size	Colour	Quantity	Pack
8100	Extra Small	Clear	18 Hooks / 24 Strips	12
8101	Small	White	5 Hooks / 8 Strips	12
8103	Large	White	5 Hooks / 8 Strips	12

Picture Wire Hanging Hooks

- Easy to use re-usable hooks designed not to damage or impact on walls
- Use for hanging pictures, canvases, photographs and other frames
- Ideal for student halls, rental homes, caravans and other areas where walls need to be kept free from damage caused by nails or screws
- Featuring a heavy-duty adhesive that creates a strong bond to the wall
- Once the hooks are not required, they can be removed by simply stretching off the adhesive – leaving the wall undamaged, with no unsightly holes or marks
- Supplied with additional adhesive strips, allowing them to be removed and used again and again



Product No	Size	Quantity	Pack
8201	Medium	2 Hooks / 4 Strips	12
8202	Medium	6 Hooks / 9 Strips	12
8203	Large	1 Hook / 2 Strips	12

Picture Hanging Strips

- Easy to use re-usable hooks designed not to damage or impact on walls
- Ideal for student halls, rental homes, caravans and other areas where walls need to be kept free from damage caused by nails or screws
- Featuring a heavy-duty adhesive that creates a strong bond to the wall
- Once the hooks are not required, they can be removed by simply stretching off the adhesive – leaving the wall undamaged, with no unsightly holes or marks



Product No	Size	Quantity	Pack
8204	Small	4 Pairs	12
8205	Medium	4 Pairs	12

Decorative Cone Hooks

- Easy to use re-usable hooks designed not to damage or impact on walls
- Ideal for student halls, rental homes, caravans and other areas where walls need to be kept free from damage caused by nails or screws
- Featuring a heavy-duty adhesive that creates a strong bond to the wall and are ideal for hanging items around the home and office
- Once the hooks are not required, they can be removed by simply stretching off the adhesive – leaving the wall undamaged, with no unsightly holes or marks
- Supplied with additional adhesive strips, allowing them to be removed and used again and again



Product No	Colour	Quantity	Pack
8305	Chrome	2 Hooks / 4 Strips	12
8304	White	2 Hooks / 4 Strips	12

Nail-In Pads

- Felt protects wooden floors



Product No	Size	Pack
9934	25mm	12
9935	38mm	12

Slide Glides

- Moves furniture and appliances easily
- Attach with screw fixing or adhesive



Product No	Size	Pack
9452	25mm	6
9453	51mm	6

Furniture Rests

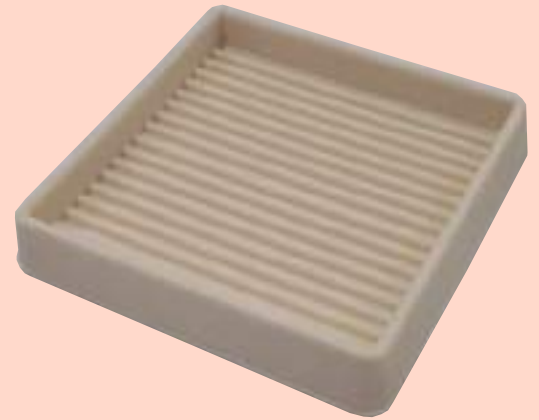

Product No	Type	Colour	Size	Pack
9168	Square Rubber	Almond	75mm	6

Surface Gard Furniture Protection



Product No	Type	Colour	Size	Pack
9956	Cut To Size Felt Sheets	Black	153mm x 113mm	12
9957	Round Felt Pads	White	10mm	12
9958	Round Felt Pads	Black	13mm	12
9959	Round Felt Pads	Black	22mm	12
9423	Assorted Round Felt Pads	Green	Various	12
9962	Round Cork Pads	Natural	13mm	12
9961	Round Cork Pads	Natural	19mm	12
9964	Round Vinyl Pads	Clear	10mm	12
9967	Round Vinyl Pads	Clear	13mm	12
9965	Round Vinyl Pads	Clear	19mm	12
9560	Cushion Bumpers Vinyl	White	13mm	6
9563	Cushion Bumpers Vinyl	White	19mm	6
9974	Non Slip Foam Pads	Black	13mm	6

Castor Cups



Felt Base

Product No	Colour	Size	Pack
9370	Beige	44mm	6
9372	Beige	60mm	6
9371	Brown	44mm	6
9373	Brown	60mm	6
9363	Light Wood Grain	44mm	6
9364	Light Wood Grain	60mm	6
9361	Dark Wood Grain	44mm	6
9362	Dark Wood Grain	60mm	6

Non-Slip Base

Product No	Colour	Size	Pack
9325	Light Wood Grain	44mm	6
9326	Light Wood Grain	60mm	6
9327	Dark Wood Grain	44mm	6
9328	Dark Wood Grain	60mm	6

Rubber

Product No	Colour	Size	Pack
9367	Brown	44mm	6
9368	Almond	44mm	6

Castor Cups For Carpets



Product No	Type	Colour	Size	Pack
9374	Plastic	Clear	45mm	10
3191	Plastic Bulk Pack of 100	Brown	45mm	1
3193	Plastic Bulk Pack of 100	Brown	60mm	1
9082	Spiked Plastic	Clear	48mm	6

Heavy Duty Felt

- Heavy duty felt protects wooden floors



Product No	Type	Size	Pack
9950	Cut To Size Sheets	153 x 113mm	12
9951	Round Pads	19mm	12
9952	Round Pads	25mm	12
9953	Round Pads	38mm	12
9927	Round Pads	50mm	6
9928	Round Pads	75mm	6
9954	Strips	13mm x 153mm	12
9947	Multi-Pack	Various	6

Rubber Leg Tips for Tubular Furniture



Product No	Colour	Size	Pack
31925	White	19mm	6
31926	White	22mm	6
31927	White	25mm	6
32014	White	28mm	6
31930	Black	19mm	6
31931	Black	22mm	6
31932	Black	25mm	6
32016	Black	28mm	6

Smart LED On/Off Dimmable GLS Bulb

- On/off and dimmable function
- WiFi enabled
- App/voice controlled
- Works with Amazon Alexa and Hey Google
- Easy set up
- Sets schedules and timers
- Group/room control or single control
- Downloadable app



Product No	Watt	Colour	Cap	Pack
ST216327	9	Warm White	BC	8
ST216334	9	Cool White	BC	8

Smart LED Colour Changing Temperature GLS Bulb

- Temperature colour changing function
- WiFi enabled
- App/voice controlled
- Works with Amazon Alexa and Hey Google
- Easy set up
- Sets schedules and timers
- Group/room control or single control
- Downloadable app



Product No	Watt	Cap	Pack
ST216310	9	ES	8

Smart LED Colour Changing Temperature Candle Bulb

- Temperature colour changing function
- WiFi enabled
- App/voice controlled
- Works with Amazon Alexa and Hey Google
- Easy set up
- Sets schedules and timers
- Group/room control or single control
- Downloadable app



Product No	Watt	Cap	Pack
ST216341	5.5	SES	8

Smart LED Colour Changing Temperature Round Bulb

- Temperature colour changing function
- WiFi enabled
- App/voice controlled
- Works with Amazon Alexa and Hey Google
- Easy set up
- Sets schedules and timers
- Group/room control or single control
- Downloadable app



Product No	Watt	Cap	Pack
ST216594	5.5	SES	8

Smart LED Colour Changing Temperature GU10 Bulb

- Temperature colour changing function
- WiFi enabled
- App/voice controlled
- Works with Amazon Alexa and Hey Google
- Easy set up
- Sets schedules and timers
- Group/room control or single control
- Downloadable app



Product No	Watt	Cap	Pack
ST216358	5.5	GU10	8

Smart LED Colour Changing RGBW Tape

- RGB colour changing function
- WiFi enabled
- App/voice controlled
- Works with Amazon Alexa and Hey Google
- Easy set up
- Remote control included
- Light controlled by music function
- Sets schedules and timers
- Group/room control or single control
- Downloadable app



Product No	Watt	LED	Length	Pack
ST218048	15	90	3m	4
ST218055	15	150	5m	4

STATUS[®]

Smart Home

works with | alexa

works with
Google Home

- Our smart products work via your **home Wi-Fi**.
- Set schedule and timers that **suit your lifestyle**.
- Create the **perfect room ambience**, using colour to set the mood.
- Control your home with the **Status Smart App**.

Control your home via **Simple Voice Commands**.

¹With compatible smart assistants.



LED Clear Filament Dimmable GLS Bulb



LED Clear Filament Dimmable Candle Bulb



LED Clear Filament Dimmable Round Bulb



Product No	Watt	Colour	Cap	Pack
ST204508	4.5	Warm White	BC	10
ST204515	4.5	Warm White	SES	10

Product No	Watt	Colour	Cap	Pack
ST204485	7	Warm White	BC	10
ST220348	7	Warm White	ES	10

Product No	Watt	Colour	Cap	Pack
ST204546	4.5	Warm White	SES	10

LED Clear Filament GLS Bulb



LED Clear Filament Candle Bulb



LED Clear Filament Round Bulb



Product No	Watt	Colour	Cap	Pack
ST199637	2.5	Warm White	BC	10
ST199644	2.5	Warm White	ES	10
ST199651	2.5	Warm White	SES	10
ST195073	4.5	Warm White	BC	10
ST195356	4.5	Warm White	ES	10
ST195080	4.5	Warm White	SES	10

Product No	Watt	Colour	Cap	Pack
ST195042	4.5	Warm White	BC	10
ST219618	7	Warm White	BC	10
ST218024	7	Warm White	ES	10

Product No	Watt	Colour	Cap	Pack
ST195134	2.5	Warm White	BC	10
ST195370	2.5	Warm White	ES	10
ST195141	2.5	Warm White	SES	10
ST195110	4.5	Warm White	BC	10
ST195387	4.5	Warm White	ES	10
ST195127	4.5	Warm White	SES	10

LED GLS Bulb Box Pack



LED Candle Bulb Box Pack



LED Round Bulb Box Pack



Product No	Watt	Colour	Cap	Pack
ST193093	5	Warm White	BC	10
ST193109	5	Warm White	ES	10
ST193116	5	Warm White	SES	10

Product No	Watt	Colour	Cap	Pack
ST192980	6	Warm White	BC	10
ST200890	6	Warm White	ES	10
ST200418	9	Warm White	BC	10
ST200425	9	Warm White	ES	10
ST216846	15	Warm White	BC	10
ST216853	15	Warm White	ES	10

Product No	Watt	Colour	Cap	Pack
ST193185	3	Warm White	BC	10
ST193192	3	Warm White	ES	10
ST193208	3	Warm White	SES	10
ST193215	5	Warm White	BC	10
ST193222	5	Warm White	ES	10
ST193239	5	Warm White	SES	10

LED 100° GU10 Bulb Box Pack



LED 38° GU10 Bulb

Product No	Watt	Colour	Cap	Pack
ST194212	4.9	Warm White	GU10	10



LED 38° MR16 Bulb



Product No	Watt	Colour	Cap	Pack
ST199552	5	Cool White	GU10	10
ST193314	5	Warm White	GU10	10

Product No	Watt	Colour	Cap	Pack
ST222212	5	Warm White	MR16	10

LED Pygmy/Fridge Bulb



LED Capsule Bulb

Product No	Watt	Cap	Pack
ST193499	1.5	G4	10
ST204560	2	G9	10



LED Linear Bulb



Product No	Watt	Colour	Cap	Pack
ST193512	1.5	Warm White	SES	10

Product No	Watt	Size	Cap	Pack
ST200388	8	118mm	R7	6

LED Strip Light Bulb



LED Clear Filament Cookerhood Bulb

Product No	Watt	Colour	Cap	Pack
ST203037	2.5	Warm White	SES	10



Oven Bulb



Product No	Watt	Colour	Size	Pack
ST189737	4.5	Warm White	284mm	6

Product No	Watt	Cap	Pack
ST143500	15	SES	16

13 Amp Plug

- 13 Amp fuse
- BS1363-1
- Sleeved pins
- Rewireable
- Supplied in a counter display



Product No	Pack
ST120150	16

Shaver Adaptor

- 1 Amp fuse
- BS1363
- Sleeved pins
- Maximum load of 1 Amp
- Supplied in a counter display

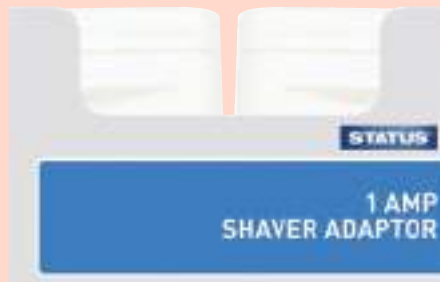

Product No	Pack
ST132450	16

2 Way Non-Fused Adaptor

- Non-fused
- BS1363-3
- Sleeved pins
- Maximum load of 13A 220V~250V 50Hz
- Supplied in a counter display

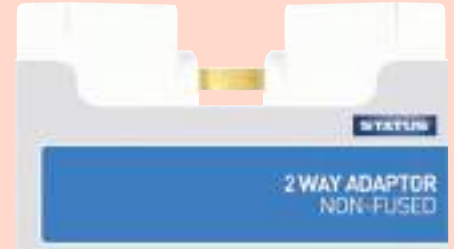

Product No	Pack
ST127401	8

3 Way Fused Adaptor

- 13 Amp fuse
- BS1363
- Sleeved pins
- Maximum load of 13A 220V~250V 50Hz
- Supplied in a counter display

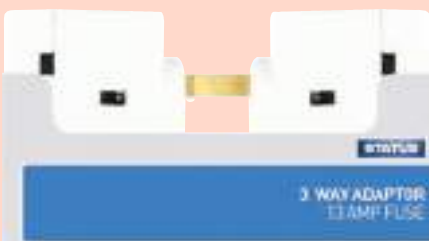

Product No	Pack
ST120051	8

European Travel Adaptor

- Not for use in the UK
- For use in all European and Mediterranean countries
- Indoor use only
- IEC60884
- Maximum load of 7.5 Amps



Product No	Pack
ST201293	12

UK Visitor Adaptor

- Suitable for visitors from Europe, USA and Australia
- 13 Amp fuse
- BS1363-3
- Maximum load of 13 Amps
- Sleeved pins
- Indoor use only
- 240v mains supply



Product No	Pack
ST159914	12

Heavy Duty Socket

- Available in 1 or 2 gang
- BS1363
- Maximum load of 13A 220V~250V



Product No	Type	Pack
ST192645	1 Gang	6
ST192652	2 Gang	6

Cable Free Socket

- 3 socket outlet
- BS1363-3 BS5733
- 13 Amp fuse
- Sleeved pins
- Maximum load of 13A 220V~250V 50Hz
- Tamper proof screws



Product No	Type	Pack
ST194984	3 Way	4

Extension Socket

- BS1363/A
- Neon indicator
- Fitted 13 Amp plug
- Tamper proof rivets
- Non-rewireable socket
- Maximum load of 13A 220V~250V 50Hz
- Poly bag and handle packaging



Product No	Type	Length	Pack
ST136120	1Way	5m	10
ST136137	2 Way	5m	20
ST172173	4 Way	2m	20
ST180192	4 Way	5m	20
ST136144	6 Way	2m	20

Cable Reel

- BS EN 61242
- Fitted 13 amp plug
- Thermal cut-out



Product No	Length	Pack
ST207547	10m	6
ST167810	20m	2
ST167803	50m	1

Starter Switch

- Fluorescent lamp starter switch
- BS EN 60155
- Easy to replace
- 2 pack



Product No	Type	Pack
ST154223	4-65W	6
ST155176	70-125W	6

Fuses

- 4 pack
- BS1362



Product No	Type	Pack
ST122857	3 Amp	10
ST122802	5 Amp	10
ST122758	13 Amp	10

Multi Amp Fuse Wire

- 3 pack
- BS1362
- Maximum load 1250W



Product No	Pack
ST174306	20

Terminal Block

- 12 connector block



Product No	Type	Pack
ST194861	5 Amp	12
ST194878	15 Amp	12
ST194885	30 Amp	12

Unswitched Lamp Holder

- Bayonet cap
- 2 Amp
- BS61184
- T2 rated
- Maximum load of 100W 220V~250V
- Fitting instructions included



Product No	Pack
ST172456	6

Switched Lamp Holder

- Bayonet cap
- 2 Amp
- BS61184
- T2 rated
- Maximum load of 100W 220V~250V
- Fitting instructions included



Product No	Pack
ST166042	12

6 Inch Ceiling Pendant

- Bayonet cap
- 6 Amp
- BS60598
- T2 rated
- Maximum load of 100W 220V~250V
- Wiring diagram included



Product No	Pack
ST172869	4

Ceiling Rose Batten Holder

- 5 Amp
- Bayonet cap
- T2 rated
- Maximum load of 100W 220V~250V
- Fitting instructions and wiring diagram included



Product No	Pack
ST173927	3

6 Amp Ceiling Switch With Pull Cord

- Adjustable pull cord
- BS60669
- 220V~250V
- Fitting instructions and wiring diagram included



Product No	Pack
ST172746	3

45 Amp Ceiling Switch With Pull Cord

- On/off neon indicator
- Adjustable pull cord
- 220V~250V
- Fixing screws included
- Fitting instructions and wiring diagram included



Product No	Pack
ST173941	3

2 Way Light Switch

- 10 Amp / 220V~250V
- BS60669
- Twin and earth terminals
- Fixing screws included
- Fitting instructions and wiring diagram included



Product No	Type	Pack
ST172661	1 Gang	5
ST172203	2 Gang	5

Switched Wall Socket

- On/off switch
- 13 Amp / 220V~250V
- BS1363
- Fixing screws included
- Fitting instructions and wiring diagram included



Product No	Type	Pack
ST172524	1 Gang	3
ST172739	2 Gang	4

Switched Wall Socket With 2 USB Ports

- On/off switch
- 13 Amp / 220V~250V
- 2 x USB charging ports
- Maximum load of 2100mA
- EN60950



Product No	Type	Pack
ST205161	1 Gang	4
ST192683	2 Gang	4

Plastic Pattress Box

- BS60670
- 25mm depth
- Surface mountable



Product No	Type	Pack
ST172777	1 Gang	4
ST172715	2 Gang	4

Metal Pattress Box

- BS4662
- 25mm depth
- Fixes into the wall (not surface mountable)



Product No	Type	Pack
ST180536	1 Gang	3
ST180543	2 Gang	3

Dry Lining Box

- BS60670
- 45mm depth
- Fixes into plaster boarded / dry lined walls



Product No	Type	Pack
ST193796	1 Gang	3
ST193789	2 Gang	3

Telephone Extension Lead

- Extension lead for telephone line
- 10m lead length



Product No	Pack
ST167544	3

24 Hour Timer Switch

- Plug-in
- BS1363-3
- 15 minutes push-down segments
- Manual on/off override
- Not for use on immersion heaters



Product No	Pack
ST123908	6

Cable Free Plug In Door Chime

- BS1363
- 150m range
- 32 melody tunes
- Easy installation, no wiring required
- Bell push has battery included
- Doorbell uses self-learning technology IC chip, with 1 million running codes to prevent any interference



Product No	Pack
ST152908	6

Photoelectric Smoke Alarm

- 9V
- BSEN14604
- Alarm test button
- Low battery signal
- 85dB alarm
- Battery operated
- Battery included
- Easy installation



Product No	Pack
ST170612	5

Carbon Monoxide Digital Alarm

- Provides early warning of the presence of CO in the home
- Loud 85dB alarm
- Low battery warning
- Test button
- LCD display
- Easy to install
- Battery operated
- Batteries included



Product No	Pack
ST194342	4

Round Cable Clips

- Use to keep cables neat and tidy
- Pack contains: 100no. 10mm and 50no. 5mm



Product No	Size	Pack
ST187665	5mm & 10mm	3

Cable Ties

- Use to keep cables neat and tidy
- Pack contains: 100mm, 25no. red and 25no. yellow 200mm, 25no. blue and 25no. black



Product No	Size	Pack
ST207417	100mm & 200mm	12

Hook & Loop Reusable Cable Straps

- Use to keep cables neat and tidy
- Reusable
- 5 mixed colours per pack: green, yellow, red, blue and black



Product No	Size	Pack
ST180253	150mm	12



Gorilla Glue

- Incredibly strong
- Ideal for most household fixes
- Bonds stone, metal, wood, ceramic, foam, glass, brick, concrete and more
- Can be used internally and externally
- 100% waterproof and temperature resistant
- Sandable, paintable and stainable



Product No	Size	Pack
1044202	60ml	5
1044404	115ml	8
1044805	250ml	6

Gorilla Glue Clear

- So clear it's virtually invisible
- Foam-free formula that doesn't expand when curing
- Seamless glue lines for a highly professional finish
- Ideal for glass applications, broken tiles, stone work and nearly all clear fixes



Product No	Size	Pack
1244002	50ml	5
1244401	110ml	8

Gorilla Wood Glue

- Incredibly strong
- Engineered to meet the demands of professional contractors and woodworkers
- Clamp time of just 20 minutes on most materials
- Internal and external use
- D3 water resistance
- Dries natural colour



Product No	Size	Pack
5044401	118ml	12
5044800	236ml	12
5044181	532ml	12
5044361	1L	4

Gorilla Super Glue

- Great impact strength
- Unique rubber particles provide built-in shock resistance for a less brittle bond
- Anti-clog cap with metal pin keeps nozzle clean and air tight
- Bonds just about anything
- Sticks to rubber, paper, wood, metal, ceramics, leather, most plastics and more
- Dries in 30-60 seconds



BEST SELLER

Product No	Size	Pack
404101	3g 2 Pack	10
4044201	15g	6
4044251	25g	6

Gorilla Super Glue Micro Precise

- The same strong and fast formula, now in a precise dispensing tool designed to fit comfortably in-hand
- Provides an easy-to-use, precise application
- Applies only the amount of glue required, in the exact place
- Anti-clog cap to ensure an airtight seal for maximum reusability



Product No	Size	Pack
4044702	5g	6

Gorilla Super Glue Brush & Nozzle

- Two ways to dispense for control and accuracy
- High strength and quick set-time make this the go-to product for a variety of household projects
- Developed for long-lasting repairs in an instant
- Dries in 10-30 seconds and is reinforced with rubber for increased impact resistance
- Stands up to wear and tear unlike any other instant glue
- Anti-clog cap with a metal pin inside to ensure an airtight seal for maximum reusability



Product No	Size	Pack
4044501	12g	6

Gorilla Super Glue Gel

- No run, control gel formula
- Great for use on vertical surfaces
- Bonds in 10 seconds
- Impact-tough
- Instant repairs on smaller, indoor projects
- Perfect for use on wood, stone, metal, ceramics, brick, paper, rubber and more
- Sandable
- Reduced clogging, with anti-clog tip
- Only 1 dab per sq. inch recommended



Product No	Size	Pack
4044601	3g 2 Pack	10
4044401	15g	6

Gorilla Epoxy

- Dries crystal clear
- Ideal for areas where an invisible bond is required
- Fills voids and bonds uneven vertical surfaces
- 5 minute setting time
- Withstands moderate exposure to water



Product No	Size	Pack
6044001	25ml	10

Gorilla Contact Adhesive

- A flexible, fast-setting, crystal clear glue that creates a strong, permanent bond
- Paintable and waterproof
- Repositionable - holds in seconds but allows flexibility when positioning
- Ideal for fabrics, it is washing machine safe and can withstand rain
- Applies and dries clear - ideal for glass



Product No	Size	Pack
2144001	75g	6

Gorilla Heavy Duty Grab Adhesive

- Grabs virtually anything instantly
- All-purpose way to bond building materials
- For indoor and outdoor use
- Can be used underwater
- Withstands extreme temperatures
- Gap-filling properties
- Paintable
- Ideal for use on wall partitioning, paneling, bathrooms, kitchens, worktops, flooring, decking, stonework and more



Product No	Colour	Size	Pack
2044101	White	290ml	12
2044311	White	200ml	6
2044301	White	80ml	6
2044402	Clear	270ml	12

Gorilla All-Conditions Sealant

- All-purpose, multi-surface sealant
- Perfect for both indoor and outdoor projects
- Repels and prevents the growth of mould and mildew
- Can be exposed to water in just 30 minutes after application
- Waterproof, shrink and crack proof
- Lifetime guarantee



Product No	Colour	Size	Pack
1144011	White	295ml	12
1144111	Clear	295ml	12

Gorilla Tape

- Extra strong grip
- Double-thick adhesive fills in gaps on all surfaces
- Sticks easily to wood, stone, stucco and brick
- Tough all-weather shell
- Tight woven backing makes it extra strong
- Available in handy 1" roll



Product No	Colour	Size	Pack
3044001	Black	48mm x 11m	6
3044011	Black	48mm x 32m	6
3044301	Black	73mm x 27m	6
3044401	Black	25mm x 9m	12
3044601	White	48mm x 27m	6
3044901	Silver	48mm x 32m	6

Gorilla Tape Crystal Clear

- Combines high strength with ultimate clarity
- Incredibly strong and perfect for virtually invisible repairs
- Forms a flexible, airtight seal, indoors and out - it even sticks underwater
- Hand tearable with an ultra-strong adhesive layer
- Perfect for professionals, DIY, crafting and everyday uses
- Use for sealing paddling pools, repairing camping equipment, phone screens and more



Product No	Size	Pack
3044701	48mm X 8.2m	6

Gorilla All-Weather Extreme Tape

- Withstands extreme weather
- 100% waterproof and holds strong in rain, snow, sun, and extreme weather conditions
- Extra-durable
- Resists cracking and peeling caused by weather extremes
- Strong, reinforced backing offers incredible strength yet can still be ripped neatly by hand
- The butyl adhesive creates a long-lasting bond which can withstand climatic extremes



Product No	Size	Pack
3044021	48mm x 11m	6

Gorilla Waterproof Patch & Seal Tape

- Extra-strong adhesive tape designed to patch holes, cracks, gaps and tears
- Perfect for instantly repairing emergency leaks
- The rubberised, UV-resistant backing can be flexed and stretched before application to adapt to the surface
- Once the extra strong tape has bonded, it stays that way
- Suitable for hot, cold, wet and dry conditions
- Forms a permanent bond and provides a waterproof barrier, indoors and out
- Great for: roofing, flashing, window frames, gutters, drainage pipes, tarpaulins, caravans, trailers, camping, pond liners, paddling pools and inflatables



Product No	Colour	Size	Pack
3044721	Black	100mm x 3m	3
3044751	Clear	100mm x 3m	3

Gorilla Heavy Duty Mounting Tape

- Provides a quick and easy solution to mount and repair where traditional fasteners can't
- Industrial strength clear tape
- Grips to smooth and rough surfaces, delivering an instant and weatherproof bond
- Indoor and outdoor use



Product No	Colour	Size	Pack
3044101	Clear	25mm x 1.5m	6
3044111	Clear	25mm Squares	6
3044121	Clear	25mm x 3.8m	5
3044201	Black	25mm x 1.5m	6

Gorilla Packaging Tape

- Easy to grip dispenser and heavy duty strength tape
- The perfect solution for moving, shipping and storing
- Moisture and temperature resistant for ultra durability wherever its used
- Easy refill dispenser makes application hassle free



Product No	Type	Pack
3044801	Tape & Dispenser	6
3044821	Refill 2 Pack	6

Heavy Duty Spray Adhesive

- Heavy duty permanent bond
- Indoor and outdoor use
- Repositionable
- Dries clear
- Photo safe
- Multi purpose, multi surface
- For DIY, craft, office, and upholstery use
- Bonds wood, MDF, metals, fabric, plastic, foam, paper, glass, leather, felt, stone, ceramics and more



Product No	Size	Pack
114943	400ml	6

Waterproof Coat & Seal Spray

- A flexible, rubberised repair spray that seals out water, air and moisture
- Perfect for repairing leaks, the spray is accurate and easy to apply
- The self levelling formula seals and protects by smoothly covering small gaps and cracks to create a weatherproof, watertight seal
- Great for use on roofing, gutters, conservatories, drainage pipes, windows, caravans, external chimneys and more



Product No	Size	Pack
1151736	450ml	6

Heavy Duty Expanding Foam

- Indoor and outdoor use
- Multi purpose, high density and gap filling
- Precise control makes it easy to apply
- Seals out water, air, moisture, and pests
- Reduces drafts
- Temperature and weather resistant
- Adheres to all common building surfaces
- Great for: attics, doors, crawlspaces, floors, garage doors, masonry, plumbing, vents, PVC, windows, skylights and more



Product No	Size	Pack
114972	340ml	6

Gorilla Clipstrips

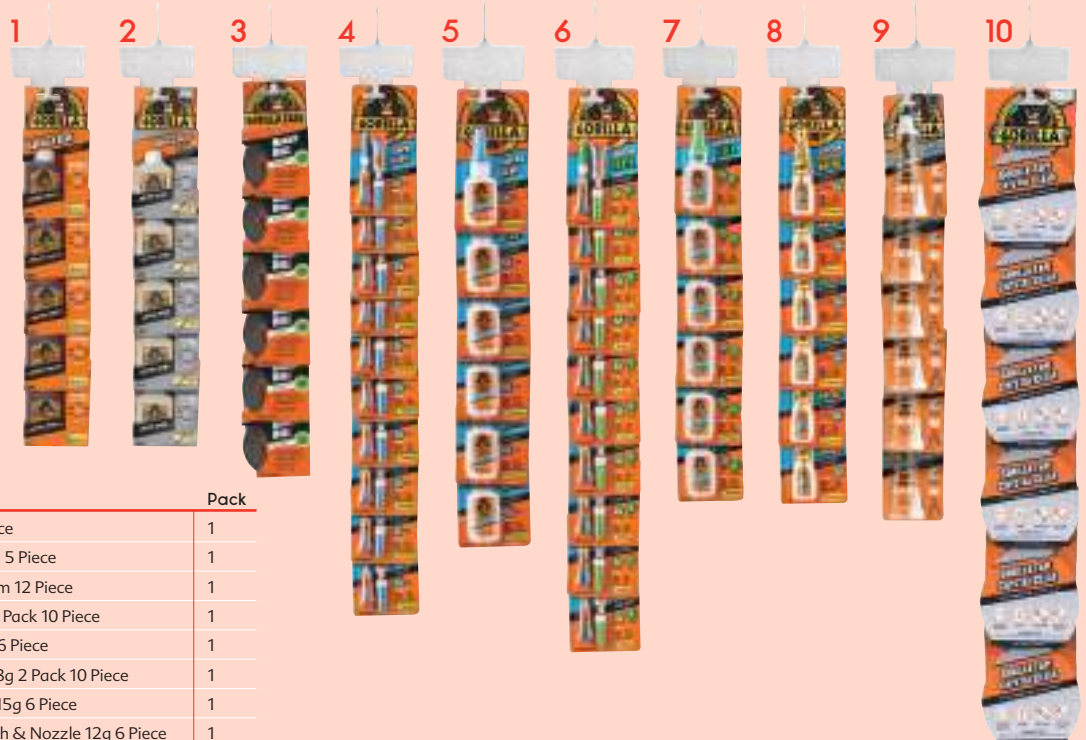

	Product No	Type	Pack
1	1044206	Gorilla Glue 60ml 5 Piece	1
2	1244005	Gorilla Glue Clear 50ml 5 Piece	1
3	3044405	Gorilla Tape 25mm x 9m 12 Piece	1
4	4044104	Gorilla Super Glue 3g 2 Pack 10 Piece	1
5	4044209	Gorilla Super Glue 15g 6 Piece	1
6	4044602	Gorilla Super Glue Gel 3g 2 Pack 10 Piece	1
7	4044407	Gorilla Super Glue Gel 15g 6 Piece	1
8	4044503	Gorilla Super Glue Brush & Nozzle 12g 6 Piece	1
9	2044005	Gorilla Heavy Duty Grab Adhesive 80ml 6 Piece	1
10	3044703	Gorilla Tape Crystal Clear 48mm x 8.2m 6 Piece	1

Sinks, Showers & Baths Unblocker

- A sodium hydroxide solution
- Designed to clear fat, grease and hair from kitchen sink, basin, bath and shower waste outlets



Product No	Size	Pack
KOKB.50	500ml	6
KOKB001	1L	4

Drains, Toilets & Urinals

- Unblock outside drains, toilets and urinals
- Contains wetting agent to accelerate action, suspend material and improve flow
- Ready to use formulation
- Breaks down the fats, grease and hair that commonly cause blockages or slow running wastes, leaving waste pipes clean and sanitized



Product No	Size	Pack
KODT.50	500ml	6
KODT001	1L	4

Biological Drain Treatment

- Active against all fats, carbohydrates, proteins and cellulose, without the need of any harmful or corrosive chemicals
- Safe for all drains, including septic tanks
- Can be used regularly as a maintenance product



Product No	Size	Pack
KOBD001	1L	6

Septic Tank Treatment

- Contains beneficial natural organisms to effectively digest septic tank waste, maintaining the balance required to ensure optimum efficiency of the system



Product No	Size	Pack
KOST001	1L	4

Household Ammonia

- Multi-purpose cleaner and laundry aid
- Cleans and degreases
- Also used to remove wax polish from floors



Product No	Size	Pack
AMMO.50	500ml	6

Caustic Soda

- Granules for dissolving in cold water to clear blocked drains and clean surfaces
- Can also be used to strip paint when neutralising with white vinegar
- Where kitchen waste disposal units are fitted or connected to a septic tank, use Knockout Biological Drain Treatment



Product No	Size	Pack
CSA6.50	500g	6
CSA6001	1kg	6
CSAK004	4kg	1

Multi-Purpose Descaler

- Strong and fast acting
- Use for descaling kettles, shower heads, and steam irons
- Efficient formic acid based formula removes limescale



Product No	Size	Pack
DEAK.25	250ml	12

Mould Stain Cleaner

- Cleans and bleaches stains caused by mould spores, fungus and algae from most surfaces including grout and the surface of silicone seals and other damp areas
- Once cleaned and with regular use it will help prevent re-growth and the reappearance of fungal stains
- With a 360° head for ease of use and accurate spray action
- For interior or exterior use



Product No	Size	Pack
KOMS.50	500ml	6

Mould & Mildew Cleaner

- For the control of mould, algae and fungi
- Suitable for use on most surfaces including timber, concrete, brick, plaster, stone, and tiles
- For internal and external use



Product No	Size	Pack
KOMM004	4L	4

Oil & Grease Remover

- Ready to use oil and grease cleaner
- Removes stubborn oil and grease stains
- Can be used neat to directly treat the stain
- Suitable for use on concrete, stone, and brick paths and driveways and all paving materials
- Not suitable for use on tarmac
- Ideal for general cleaning, degreasing, grime and dirt removal
- Can be applied by brush, cloth or mop
- Low odour formulation



Product No	Size	Pack
KOGR004	4L	4

Driveway, Decking & Patio Cleaner

- For use on most hard surfaces including: timber, concrete, brick, plaster, stone and tiles
- Can also be used internally on timber or stone surfaces to remove mould and algae prior to painting/decorating
- Contains a surface biocide to kill and reduce future mould and algae growth
- HSE registered product contains Benzalkonium Chloride
- Ready to use formulation



Product No	Size	Pack
DECL004	4L	4

Rapid Rescue Stain Remover

- Eco friendly yet powerful stain and smell remover (not perfumed)
- Beneficial natural microbes literally eat the stain and smell
- Won't damage surfaces
- Removes: food (including dairy and red wine), pet mess and smell, child accidents and sickness, smoke/cigarette smells
- Multiple uses in the home and trade
- Can be used on carpets, soft furnishings, hard floors, and in vehicles



Product No	Size	Pack
KORR.75	750ml	6

Anti-Fog Glass Cleaner

- Amazing fog preventing coating
- Cleans then leaves a fog beating film behind
- Great for steamy bathrooms and kitchens



Product No	Size	Pack
KOAF.50	500ml	6

Quicklight Fire Lighting Gel

- The easier way to light traditional fires, coal fires and chimeneas
- Instant lighting
- Low odour formula
- Bottled with a directional spout



Product No	Size	Pack
QLFGC01	1L	6

Liquid Heat Drain Unblocker

- Stronger, fast acting formula opens tough clogs in minutes
- Perfect for tough bathroom clogs
- Pours through standing water and penetrates the clog
- Dissolves build up, hair, and soap scum
- Safe for pipes and septic systems



Product No	Size	Pack
ZE281172	1L	6

10 Minute Hair Clog Remover

- Formulated to quickly dissolve hair clogs
- Ideal for use in sinks, baths and shower drains
- Safe for pipes and septic systems



Product No	Size	Pack
ZE280694	1L	6

CarPlan® Demon®

Your guide to a Wicked Shine!

Our Demon Shine treatment provides a wicked top gloss & waxed finish without the hard work! No hard rubbing or polishing, just a mirror finish shine that lasts for weeks. Use on paintwork, wheels and bumpers.

Our patented Demon Show Foam generates a dense foam that is easy to set up and use whilst relying only on standard household water pressure. Demon Foam effortlessly lifts dirt & contaminants from the surface & the high performance detergents powerfully remove all traces of traffic film, dirt and grease, leaving a spotless, streak-free and shiny finish.

CSV200 - CarPlan Demon Shine With Venturi Spray Gun 2L

CDW200 - CarPlan Demon Foam With Snow Foam Gun 2L

CDS101 - CarPlan Demon Shine 1L

CDW101 - CarPlan Demon Foam 1L

CDM101 - CarPlan Demon Machine 1L

CDD010 - CarPlan Demon Fresh 1L



CDE101 - CarPlan Demon Wheels 1L

CDC101 - CarPlan Demon Clean 1L

CDT101 - CarPlan Demon Tyres 1L

CDF101 - CarPlan Demon Fabric 1L

CDG101 - CarPlan Demon Glass 1L

9 EASY steps to car care:

- 1 Demon Machine**
Dissolves muck... right off!
- 2 Demon Wheels**
Cleans ALL wheels
- 3 Demon Foam**
Active foam formula
- 4 Demon Shine**
For an instant shine
- 5 Demon Clean**
All purpose interior & exterior cleaner
- 6 Demon Tyres**
Instant tyre shine
- 7 Demon Fabric**
Super upholstery shampoo
- 8 Demon Glass**
Active glass cleaner with anti-mist
- 9 Demon Fresh**
Powerful odour eliminator



Let the Demon do the Work!

Demon Foam

- Patented snow foam shampoo which generates a dense foam that is easy to set up and use whilst relying only on standard household water pressure
- Effortlessly lifts dirt and contaminants from the surface
- High performance detergents powerfully remove all traces of traffic film, dirt and grease, leaving a spotless, streak-free and shiny finish
- With an amazing cherry fragrance



Product No	Size	Pack
CDW101	1L	6
CDW201	2L	6
CDW200	Snow Foam Gun 2L	6



Demon Shine

- Top gloss treatment provides a just waxed finish without the hard work
- No hard rubbing or polishing
- Produces a mirror finish shine that lasts for weeks
- Use on paintwork, wheels and bumpers
- Pour-on or spray-on versions
- Cherry fragranced



Product No	Type	Size	Pack
CDS101	Spray On Shine	1L	6
CSV200	Spray On Shine With Shine Gun	2L	6
CDS201	Pour On Shine	2L	6

Demon Machine

- New technology rapid dirt shifter takes the hard scrubbing out of washing vehicles
- Simply spray all over vehicle before washing and watch the formula dissolve grease, grime, bird lime and tree sap
- Can be used on vehicle paintwork, glass, plastic and chrome



Product No	Size	Pack
CDM101	1L	6

Demon Wheels

- Universal fast wheel cleaner formula is safe to use on any wheels including chrome, plastic, alloys and split rims
- The fast acting formula removes baked on brake dust, road grime and oil
- Simple spray on action



Product No	Size	Pack
CDE101	1L	6

Demon Tyres

- Silicone free tyre shine for wet look tyres
- Easy one step action provides shine and protection that lasts
- The no wipe formula leaves a long lasting wet look that seals in shine



Product No	Size	Pack
CDT101	1L	6

Demon Clean

- The unique super active cleaner can be used to clean interior and exterior surfaces of the car
- Interior uses include dashboard, windows, plastic trim and other hard surfaces
- Exterior uses include plastic and trim surfaces
- The citrus fragranced formula works by effectively removing dirt, grease and grime leaving a pleasant aroma



Product No	Size	Pack
CDC101	1L	6

Demon Fabric

- Removes tough dirt and grime from all seats, roof lining and trim panels
- Fast-acting formula penetrates and lifts the dirt and grime whilst leaving a fresh linen fragrance that helps mask stale odours caused by food, tobacco and pets etc.



Product No	Size	Pack
CDF101	1L	6

Demon Glass

- Effortlessly cleans and polishes all glass and mirrors, leaving a streak-free shine both inside and out
- The fast acting formulation efficiently removes dirt, dust, grease, tobacco haze, finger marks, tree sap, bird lime and dead insects
- Also contains anti-mist protection



Product No	Size	Pack
CDG101	1L	6

Demon Fresh

- Combats unpleasant odours from inside the car, including tobacco, food, pets and damp
- Scientifically proven to quickly and effectively counteract stale molecules, leaving a subtle, fresh fragranced aroma
- Multi-use in cars, caravans and boats



Product No	Size	Pack
CDD010	1L	6

Demon Ice

- The first ever 2 in 1 ice preventer and de-icer - Effective down to -20°C
- Spray onto the windscreen the night before to prevent ice forming
- Solution sits on the windscreen and prevents ice sticking to the glass. Any residue can be cleared with wipers
- Can also be used as a high-performance de-icer



Product No	Size	Pack
CDI001	1L	6

Demon Freeze

- Highly concentrated formula
- Can be sprayed directly onto the windscreen or as a de-icer through the washer jets
- Prevents screen wash freezing in the tank and pipes
- Can also be diluted for summer use



Product No	Size	Pack
CDF025	2.5L	6

Demon Shot

- Super concentrated screen wash
- Makes up to 25L of standard screen wash
- Can also be used to boost existing screen wash freezing temperature
- Powerful Nanomeric formulation
- Effective down to -65°C when used neat



Product No	Size	Pack
DSW050	500ml	6

Demon Cool

- Clear formulation
- Mixes with all colours
- Simply pour in and top up
- No tools required
- Suitable for both petrol and diesel engines
- Meets BS6580 (2020) and ASTM D3306



Product No	Size	Pack
DCO101	1L	6

Demon Air Freshener

- Carded air freshener
- Cherry fragrance



Product No	Pack
DAC001	12

Demon Gift Pack

Gift pack of Demon products for complete car care cleaning, supplied in an eye catching box.

- **Set includes:**
 - Demon Clean 1L
 - Demon Shine 1L
 - Demon Tyres 1L
 - Demon Wheels 1L
 - Demon Foam 1L
 - Demon Air Freshener
 - Large sponge



Product No	Pack
DGP101	1

Blue Star Anti-Freeze

- Anti-freeze and engine coolant
- 2 years protection
- Contains rust inhibitors
- Conforms to BS6580:2010



Product No	Size	Pack
BSA001	1L	12
BSA002	2L	6

Blue Star Anti-Freeze Ready Mixed

- Ready to use formulation
- Exceptional all year round protection and performance in all driving conditions
- Contains anti-corrosion additives
- Blended from coolant concentrate that conforms to BS6580:2010



Product No	Size	Pack
BSR001	1L	12

All Seasons Screen Wash

- High power concentrate
- Removes dirt, grime and insect deposits
- Helps prevent freezing



Product No	Size	Pack
SWA001	1L	12
SWA025	2.5L	6
SWA005	5L	4

All Seasons Screen Wash Ready Mixed

- Blended from high power concentrate
- Removes dirt, grime and insect deposits
- Helps prevent freezing



Product No	Size	Pack
ASW055	5L	4

Blue Star De-Icer

- Fast acting powerful de-icer
- Effective down to -15°C



Product No	Size	Pack
SDI600	600ml	12

Blue Star De-Icer Trigger

- Melts ice fast
- Effective down to -15°C



Product No	Size	Pack
TDI501	500ml	12

Fuel Can

- Safe and secure way for storing fuel in the home or garage
- Manufactured from high-density polyethylene
- Flexible pouring spout
- Comply with SI 1982/630



Product No	Colour	Size	Pack
TPF005	Red	5L	10
TPH005	Green	5L	10

Jumbo Sponge

- Super-absorbent whilst holding water and removing dirt from surfaces
- Large surface area for effective cleaning with minimum effort, and won't scratch



Product No	Pack
CTA003	12

FOR SUMMER DAYS & NIGHTS



Target Insects Outdoors

Protect outdoor spaces from flying, biting and crawling insects with effective 'every day' insect control from Zero In.

Choose from a wide range of consumables, time-release units and electronic devices to provide complete protection against unwanted infestations.



For more information or to order, contact your local sales representative.

Restrictions apply. Chemical formulations subject to regulatory approval.

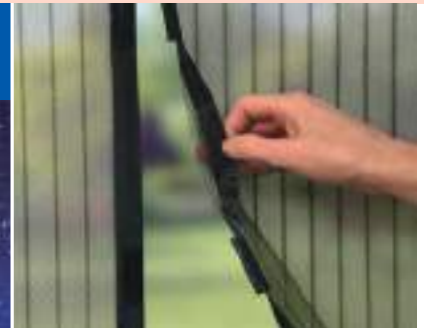

The **Big Cheese**

PROBLEM

PEST CONTROL

SOLVED

SNAP!

whenever mice and rats move in,
it's time to break out The Big Cheese!



4 EFFECTIVE WAYS

to rid your home and garden of mice and rats

**Bait
& Kill**

**Catch
& Kill**

**Catch
Alive**

Repel

Fresh Baited Trap

- Fresh baited, tested and proven to catch more rodents
- Poison-free
- Powerful spring mechanism
- Sleeved block for easy cleaning
- Suitable for indoor and outdoor use
- Refill with STV163



Product No	Type	Pack
STV194	Mouse	30
STV197	Mouse 2 Pack	12
STV195	Rat	6

Cheese Pedal Trap

- Flavoured cheese pedal requires no additional bait
- Only wood from FSC certified forests have been used for this product
- Powerful spring mechanism
- Dual settings – firm or fine



Product No	Type	Pack
STV100	Mouse 2 Pack	12
STV110	Rat	6

Wooden Trap

- Traditional trap design
- Entry-level value pack
- Powerful spring mechanism
- Indoor and outdoor use
- Flow-wrap packaging
- 10mm solid hardwood platform
- Bait with STV163



Product No	Type	Pack
STV040	Mouse 4 Pack	12
STV047	Rat 2 Pack	6

Quick Click Trap

- Powerful double-spring mechanism guarantees a quick kill
- One click to set and another click to dispose of catch
- Fresh baited and ready-to-use
- Pack of 2
- Refill with STV163



Product No	Type	Pack
STV147	Mouse	6
STV150	Rat	5



Live Catch Mouse Trap

- Simple tip-and-trap mechanism for easy setting
- Baited and ready to use
- Locking bar ensures that escape is impossible
- Welfare friendly trap that does not harm the mouse
- Twin pack



Product No	Pack
STV155	6

Live Multi-Catch Mouse Trap

- Baited and ready to use
- Catches up to 4 mice
- Self setting mechanism
- Safe for use near children and pets
- Clear view sliding lid for easy inspection and release of catch
- Unobtrusive for use around the home



Product No	Pack
STV162	6

Pet Safe Quick Click Mouse Trap

- Protect non-target animals from accidental contact with trap
- Semi-transparent housing allows for easy setting and trap inspection
- Powerful double-spring mechanism guarantees a quick kill
- Refill with STV163



Product No	Pack
STV157	4

Rat & Mouse Attractant

- Ideal for all traps
- Increases catch rate
- Clean and easy application
- Developed and tested by pest control professionals
- Contains only food grade ingredients



Product No	Size	Pack
STV163	26g	6

Mouse Bait Station

- Compact, tamper-resistant bait station with lockable lid helps protect children and pets from contact with bait (not included)
- Easy set-up and durable design for indoor and outdoor use
- A bait station is required by UK law when baiting mice and rats



Product No	Pack
STV170	12

Rat & Mouse Bait Station

- Compact, tamper-resistant bait station with lockable lid helps protect children and pets from contact with bait (not included)
- Easy set-up and durable design for indoor and outdoor use
- A bait station is required by UK law when baiting mice and rats



Product No	Pack
STV179	3

Rat Killer Grain Bait Sachet

- Palatable grain bait in single-use 150g sachet
- No bait handling required
- For indoor and outdoor use
- Must be used with a tamper-proof bait station (STV179)
- Contains Difenacoum



Product No	Pack
STV224	6

Mouse Killer Grain Bait Sachet

- No bait handling required - chew through sachets
- For indoor and outdoor use
- Must be used within a tamper-proof bait station (STV179 & STV170)
- Contains Difenacoum.



Product No	Size	Pack
STV239	3 x 25g	6

Rat & Mouse Killer Grain Bait Sachets

- Pre-measured natural grain bait sachets
- No bait handling required
- For indoor and outdoor use
- Must be used within a tamper-proof bait station (STV179 & STV170)
- Contains Difenacoum



Product No	Type	Pack
STV244	Rat & Mouse Killer 6 x 25g	6
STV245	Mouse Killer Kit	6

Mouse & Rat Killer Pasta Sachets

- Fresh pasta bait for maximum bait take
- Ideal for kitchen and food prep areas where there are competing food sources that may otherwise result in reduced bait-take
- Each pack contains gloves
- Must be used within a tamper-proof bait station (STV179)
- Contains Difenacoum



Product No	Type	Pack
STV222	Mouse & Rat Killer 6 Pack	6
STV223	Mouse & Rat Killer 15 Pack	6
STV228	Mouse Killer Kit	6

All-Weather Block Bait

- Moisture-resistant high palatability bait blocks
- Bait stays fresh in damp or wet weather
- Universal - fits all bait stations
- Indoor and outdoor use
- Must be used within a tamper-proof bait station (STV179)
- Contains Difenacoum



Product No	Size	Pack
STV211	6 x 10g	6
STV212	15 x 10g	6
STV213	30 x 10g	6

All-Weather Block Bait Mouse Killer Station

- Sealed and ready-to-use bait station
- Single use - no bait handling
- Clear inspection lid - see the bait go
- Corner fit with two-way entry
- Twin pack
- Contains Difenacoum



Product No	Pack
STV210	6

Anti Mouse Scent Sachets

- Destroys unpleasant odours and disrupts rodent pheromone trails
- All-natural formulation with powerful mint aroma
- Effective for up to 30 days
- Suitable for use in home living areas, especially food storage
- Refresh with STV405



Product No	Pack
STV401	6

Anti Mouse Refresher Spray

- Use to refresh Anti Mouse Scent Sachets
- Can also be used as a stand-alone spray-on treatment



Product No	Size	Pack
STV405	500ml	6
STV406	1L	6

Anti Mouse Lacquer

- Quick-dry formulation for surface treatment to deter rodent pests from chewing or biting treated areas
- 6 months protection of treated areas prevents damage
- Indoor and outdoor use
- Suitable for application to hard surfaces, including electric cabling and insulation
- Contains peppermint oil, castor oil, with added bittering agent



Product No	Size	Pack
STV403	300ml	6

Anti Mouse Repellent Kit

- Complete mouse repellent kit for home use
- Up to 6 months protection
- Ideal for hard-to-reach areas
- Pet-friendly kit, ideal for indoor use
- Includes STV820, STV403 and STV401



Product No	Pack
COM034	6

Anti Mouse Mini-Sonic Mouse Repellent

- New generation sonic repeller provides continuous ultrasonic output to help drive away rodents and prevent their return
- Low-cost, round-the-clock protection
- Discreet, micro-footprint does not obstruct other plug sockets
- Pet-safe and welfare-friendly deterrent that does not harm rodents
- Extended 2-year warranty



Product No	Type	Pack
STV826	Single	6
STV828	3 Pack	6

Anti Mouse Battery Powered Mouse Repellent

- Ideal for hard-to-reach areas away from mains power, i.e. lofts, sheds and garages
- Portable sonic repeller provides continuous output that's too high for humans and non-rodent pets to hear
- Single space treatment also suitable for holiday homes and caravans in out-of-season periods
- Welfare-friendly deterrent
- Low battery indicator
- Uses 3 x AA batteries which last for over 3 months (not included)



Product No	Pack
STV820	6

Sonic Repeller

- Test button halo-red LED for easy checking
- 2-year on-pack warranty
- Plug-in pest control for 24/7 home protection using ultra-sonic waves
- Protects up to 37m² and is safe for use around cats and dogs
- Maintenance free low-cost operation



Product No	Pack
STV717	6

Advanced Pest Repeller

- Combines swept ultra-sound and electromagnetic action
- Inaudible to humans, cats and dogs
- Test button and halo-red LED indicator



Product No	Pack
STV789	6

Selfset Metal Mouse Trap

- Classic trap design – made in Britain since 1947
- Galvanised metal with rust resistant springs
- Hair breadth sensitivity
- Use indoors and outdoors



Product No	Pack
TVS160	10

Selfset Metal Rat Trap

- Classic trap design – made in Britain since 1947
- Galvanised metal with rust resistant springs
- Hair breadth sensitivity
- Use indoors and outdoors



Product No	Pack
TVS165	5

The Big Cheese Clipstrips



Product No	Type	Pack
1	STV197CS Fresh Baited Mouse Trap Twin Pack	1
2	STV040CS Wooden Mouse Trap 4 Pack	1
3	STV163CS Mouse & Rat Attractant 26g	1
4	STV820CS Anti Mouse Battery Powered Mouse Repellent	1

The Big Cheese POS Displays



Contact us for details on display fills

Ultra Power Mouse Trap

- Guaranteed to kill mice fast
- One touch to set
- Baited ready for use
- Twin pack



Product No	Pack
STV148	6

Ultra Power Rat Trap

- One-touch-to-set
- Baited and ready to use
- Trap clicks open for easy disposal
- Twin pack



Product No	Pack
STV149	6

Ultra Power XL Rat Trap

- Supersized rat trap
- 50% more powerful than other traps
- Baited ready-to-use
- Removable bait cup
- Satisfaction guaranteed – money-back consumer guarantee on pack



Product No	Pack
STV108	4

Ultra Power All-Metal Selfset Mouse Trap

- All-weather galvanised mouse trap
- High performance snap and hold
- Indoor and outdoor use
- Bait with STV163
- Twin pack



Product No	Pack
STV167	10

Ultra Power All-Metal Selfset Rat Trap

- All-weather galvanised rat trap
- High performance snap and hold
- Integrated sure-grip spikes
- Indoor and outdoor use
- Bait with STV163

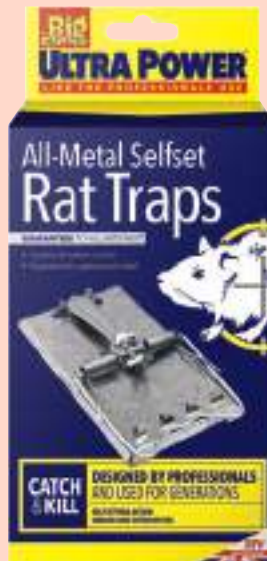

Product No	Pack
STV169	5

Ultra Power Live Multi-Catch Mouse Trap

- Galvanised steel design
- Traps 10 or more mice
- Self setting mechanism
- Safe for use near children and pets
- Clear view flip top lid for easy inspection and cleaning



Product No	Pack
STV177	6

Ultra Power Live Catch Traps

- Galvanised, heavy-duty traps with lifetime warranty
- Fast action, spring-activated trap doors for improved catch rates
- Suitable for indoor and outdoor use
- Machine-finished mesh without sharp edges to ensure safety of target pests
- Solid tops and protected carrier handles for operator safety
- Bait with STV163



Product No	Type	Pack
STV075	Rat & Small Animal	6
STV080	Multi-Catch Rat	6

Ultra Power Mouse Trap Kit

- Secure lockable trap station
- Includes baited Ultra Power Mouse Trap
- Protects children and pets from trap
- Indoor and outdoor use
- Bait block fixings included



Product No	Pack
STV563	6

Ultra Power Rat Trap Kit

- Secure lockable trap station
- Includes baited Ultra Power Rat Trap
- Protects children and pets from trap
- Indoor and outdoor use
- Bait block fixings included



Product No	Pack
STV564	6

Ultra Power Block Bait Mouse Killer Kit

- Refillable mouse bait station
- Tamper-resistant design protects children and pets from contact with bait
- Translucent inspection chamber - see the bait go
- Corner fit with two-way entry
- Easy set-up and replenish
- Supplied with 5 x 20g Brodifacoum blocks
- Fast acting bait - kills mice in one feed
- Use indoors and around buildings



Product No	Pack
STV565	5

Ultra Power Block Bait Rodent Killer Kit

- Fast acting - kills rats and mice in one feed
- Pre-baited station
- Contains 3 x 20g Brodifacoum blocks
- Refillable with lock and key feature
- Use indoors and around buildings



Product No	Pack
STV566	3

Ultra Power Block Bait Rodent Killer

- Fast acting - kills rats and mice in one feed
- Bait refills for use with STV565 and STV566
- Contains Brodifacoum
- Use indoors and around buildings



Product No	Size	Pack
STV567	6 x 20g	6
STV568	15 x 20g	6

Ultra Power All-Weather Bait Station

- Tamper-resistant bait station with lockable lid
- Protects children and pets from contact with bait
- Universal – suitable for use with all baits
- Includes ground anchors
- Use indoors and outdoors



Product No	Pack
STV175	1

Ultra Power XL Outdoor Bait Station

- Large tamper-resistant bait station for rats
- Protects children and pets from contact with bait
- Suitable for use with all baits
- Constructed with durable plastics for long-life
- Outdoor use only



Product No	Pack
STV172	1

Ultra Power Electronic Mouse Killer

- Kills 100+ mice per set of AA batteries (not included)
- Quick, effective and humane
- Kills mice in seconds
- Kill indicator shows when trap needs resetting
- Safe for use around children and pets
- Satisfaction guaranteed – money-back consumer guarantee on pack



Product No	Pack
STV722	6

NOT FOR SALE IN THE REPUBLIC OF IRELAND

Ultra Power Neo-Zap Electronic Rat Killer

- Overcomes neophobia of target rats using non-toxic bait developed by pest control professionals
- Safe and effective – kills rats in seconds
- Delivers up to 50 kills per battery set (4 x AA batteries – not included)
- Starter pack of 6 poison-free Neo-Zap Baits included
- Micro-switch protection for safe handling and re-baiting
- Smart-circuit technology re-sets automatically



Product No	Type	Pack
STV721	Rat Killer	1
STV724	Bait Refill	6

NOT FOR SALE IN THE REPUBLIC OF IRELAND

Mega-Sonic Twin-Speaker Ultrasonic Pest Repeller

- The only scientifically tested and proven ultrasonic pest deterrent on the market
- Next generation ultrasonic waves guaranteed to drive out rodent pests
- Twin speakers, wide angle output for whole room protection
- Almost double the coverage area of other repeller units (60m²)
- Low running cost: less than 1p per day



Product No	Pack
STV725	1

Mega-Sonic Plug-In Twin-Speaker Ultrasonic Pest Repeller

- Next generation attack waves guaranteed to drive out rodent pests
- 2 times more powerful than single speaker repellers
- Wide angle output for whole room protection
- Direct plug-in suitable for low-level power sockets
- Test button
- Covers an area up to 60m²
- Low running costs



Product No	Pack
STV723	1

Mega-Sonic Multi-Speaker Ultrasonic All-Pest Repeller

- Multiple ultrasonic band ranges to target specific pests
- Next generation attack waves guaranteed to drive out rodent pests
- Audible test button and LED status indicator
- 360° swept ultrasonic output
- Mains powered - 9v transformer included
- 5-Speaker system covers an area over 200m²
- IP44 rating - all-weather tested



Product No	Pack
STV748	1

The Big Cheese Ultra Power Clipstrip



Product No	Type	Pack
STV148CS	Ultra Power Mouse Trap 2 Pack	1

The **Big Cheese**

PROBLEM

PEST CONTROL

SOLVED

RISK-FREE CONTROL OF MICE & RATS

find out
more



POISON-FREE SAFE & EFFECTIVE

alternatives to traditional baits and traps

**FACT: 88% of Barn Owls
have detectable traces of
rodenticide in their liver***

SUPPORT THE BIG CHEESE - WORK TOWARDS A POISON-FREE FUTURE

*UK Centre for Ecology & Hydrology Second generation anticoagulant rodenticide residues in barn owls 2020 found that overall 88% of owls had detectable liver residues of one or more SGAR

Poison Free Mouse & Rat Block Bait

- Poison-free block bait for targeted treatments using bait stations, traps and cage traps
- Highly palatable and effective mouse and rat bait
- Indoor and outdoor use, durable in damp conditions
- Clean and easy disposal in household waste



Product No	Size	Pack
STV201	30 x 10g	6

Poison Free Ready-Baited Bait Station

- See-through stations for at-a-glance monitoring of bait take
- Ready-baited, with safe and easy refill and lockable lids
- Monitor vulnerable areas continually and then treat infestations only as needed
- Refill with Mouse & Rat Block Bait (STV201)



Product No	Type	Pack
STV206	Mouse	12
STV205	Mouse & Rat	6

Poison Free Ready-Baited Multi-Catch Live Mouse Trap

- Welfare friendly control of mice
- Dual settings to monitor vulnerable areas and control as necessary
- Durable and long lasting - traps work well indoors and out
- STV043 supplied in two colours
- Refill with Mouse & Rat Block Bait (STV201)

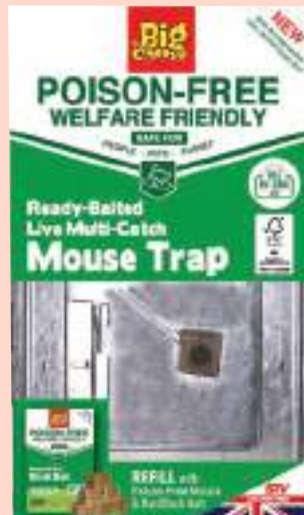

Product No	Type	Pack
STV043	Round	6
STV202	Rectangular	6

Poison Free Ready-Baited Rat Cage Trap

- Easy-set mechanisms for welfare friendly control of rats around the home and garden
- Dual settings to monitor vulnerable areas and control as necessary
- Durable and long lasting galvanised traps work well indoors and out
- Refill with Mouse & Rat Block Bait (STV201)



Product No	Type	Pack
STV203	Rat Trap	6
STV204	Multi-Catch Rat Trap	6

Mega-Sonic Solar Cat Repeller

- Deter cats from fouling on lawns and gardens
- Day and night operation
- 60m² coverage
- USB or solar Rechargeable (cable supplied)
- Weather tested to IP44 rating
- Safe for wildlife and pets
- Powered by 3 x AA Rechargeable batteries (supplied)

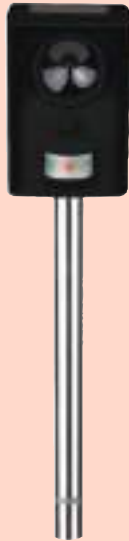

Product No	Pack
STV601	6

Mega-Sonic Cat Repeller

- Stops cats from fouling on lawns and gardens
- 50% bigger coverage area than other equivalent models
- PIR sensor
- In-built mounting stake for secure placement
- 120m² coverage
- Welfare-friendly deterrent that does not harm cats, dogs or other wildlife
- Battery or mains powered using 9v Universal Mains Adaptor (STV612)



Product No	Pack
STV606	3

9v Universal Mains Adaptor

- 9v DC adaptor with 7m cable length for use with the following:
STV606 Mega-Sonic Cat Repeller
STV608 Mega-Sonic Fox Repeller (as a replacement)



Product No	Pack
STV612	6

Cat & Dog Scatter Granules

- 100% natural and biodegradable scatter granules with aromatic plant oils
- Aversive training aid suitable for treating areas affected by cats and dogs
- STV616 re-useable pack with integrated shaker cap dispenser - treats 150m²
- STV631 compostable paper pack - use as a refill, or apply direct using this perforated shaker pack - treats 250m²
- For outdoor use only



Product No	Size	Pack
STV616	450g	6
STV631	750g	6

Cat & Dog Scatter Spray

- Natural aromatic plant oils suitable for treating any outdoor areas affected by cats and dogs
- For outdoor use only - repeat treatment every 48 hours
- Ready-to-use formulation deters cats and dogs without harm
- Child and pet safe once dried
- Contains Aluminium Ammonium Sulphate



Product No	Size	Pack
STV623	1L	6
STV624	1.5L Pressure Spray	4
STV637	2L RTU Sprayer	6

Cat & Dog Crystal Gel

- Biodegradable liquid crystals with aromatic plant oils
- Aversive training aid suitable for treating any outdoor areas affected by cats and dogs
- Treats up to 40m²
- Repeat treatments of affected areas after wet weather, or every 48 hours
- Non-garlic formulation
- For outdoor use only



Product No	Size	Pack
STV619	450ml	6

Pepper Dust

- 100% natural and biodegradable formula deters cats, dogs and wildlife from digging, scratching and fouling
- Non-harmful to animals – no need to exclude children or pets from treated areas
- STV614 re-usable pack with integrated shaker cap dispenser - treats 10m²
- STV633 compostable paper pack - use as a refill, or apply direct using this perforated shaker pack - treats 14m²



Product No	Size	Pack
STV614	300g	6
STV633	400g	6

Hot Nuts

- Formulated with natural ingredients which are an irritant and distasteful to squirrels but palatable to wild birds
- Keeps bird food for the birds
- Apply directly to bird food in feeders and on tables
- Welfare-friendly
- Contains capsicum chilli



Product No	Size	Pack
STV627	1L	6

Mega-Sonic Deer & Wildlife Deterrent

- Flashlight and audible speaker deters animals without harm
- Battery powered for easy set-up, with PIR detection to conserve battery life
- Weather-resistant housing with mounting system for easy fixing on trees, fences or walls
- Deters deer and other dawn-raiders from foraging vulnerable plants and shrubs



Product No	Pack
STV688	3

Fox & Wildlife Repellent

- Formulation deters foxes and other wildlife without harm
- Child and pet safe once dried
- Contains Aluminium Ammonium Sulphate
- Always read the label – use pesticides safely



Product No	Size	Pack
STV416	2 x 50g sachets	6
STV417	2L RTU	6

NOT FOR SALE IN THE REPUBLIC OF IRELAND

Mega-Sonic Fox Repeller

- Dual-action, audio visual deterrent with flashing red LEDs and ultrasonic repellent
- Day and night protection: intermittent flashing LED lights mimic nocturnal predator eyes to help keep foxes out of protected areas
- Mains power-pack included, with optional battery power for hard-to-reach areas
- PIR detects up to 10m range with 100m² coverage
- All-weather tested to IP44 rating
- 2-year extended warranty



Product No	Pack
STV608	3



Run Rabbit Repellent

- Simply empty sachet into a watering can or sprayer and dilute to apply
- Deters rabbits without harm
- Treats up to 34m
- Contains Aluminium Ammonium Sulphate



Product No	Size	Pack
STV419	2 x 50g	6

NOT FOR SALE IN THE REPUBLIC OF IRELAND

Prickle Strip

- Polypropylene prickles strips
- Protects properties from intruders such as cats and squirrels



Product No	Type	Size	Pack
STV909	Fence Topper - 6 pack	4.5cm x 45cm lengths	1
STV908	Fence Topper	4.5cm x 45cm lengths	24
STV907	Fence Top & Sides	2.5cm x 3cm x 45cm lengths	24
STV906	Brick & Sill Topper	23cm x 9cm lengths	24

Dig Stopper

- Prevents cats, dogs and wildlife from digging in planted areas, gravel borders and soil
- Easy to install just below ground level
- Weather resistant and durable
- 2m long x 28cm wide – can be trimmed to length or joined side-by-side



Product No	Pack
STV628	6

Animal Trap

- Easy to set cages with positive spring-loaded trigger actions and protective hand plates
- Long-lasting galvanised mesh design with external joints and no sharp edges
- Suitable for indoor and outdoor use
- Includes lifetime guarantee



Product No	Size	Pack
STV076	44cmx 19cmx 19cm	6
STV072	60cmx 19cmx 19cm	1
STV071	67cmx 27cmx 28cm	1

Repeller Ribbon

- Iridescent tape flashes and reflects light to repel birds, deer and other nuisance animals
- Protects fruit and vegetable gardens, trees, seedlings and newly seeded lawns
- Welfare-friendly deterrent that is safe for wildlife and pets
- Tough, weatherproof and long lasting



Product No	Size	Pack
STV922	30m	6

Inflatable Bird Scarer

- Protects crops and vulnerable areas from bird damage
- Inflatable eyeball with reflective eyes and streamer tail
- Wind activated movement mimics in-flight predators
- Safe for wildlife and pets



Product No	Pack
STV960	6

All-Weather Silicone Adhesive

- Cures to a cast iron grip in 24 hours
- Resistant to extreme weather conditions
- Dries clear, solvent free with low odour
- 80g tube provides enough glue for up to 3 metres of fixings
- Use to affix a range of The Big Cheese wildlife deterrents, including strips and decoys



Product No	Size	Pack
STV902	80g	6

Hawk Kite

- Effective bird scaring device, suitable for small-holdings and keen garden growers
- Pole mounted kite suspends over crops, swooping and diving even in the lightest of winds
- All-weather durable materials
- 4 metre fibreglass mounting pole and ground spike provided
- Can be mounted onto hard surfaces using STV948 Stand



Product No	Type	Pack
STV968	Hawk Kite	5
UFD005	20 Piece Display	1
STV948	Hawk Kite Stand	4

Flying Falcon

- Diving bird of prey with 21" wingspan
- Hanging system included for mounting on walls and trees



Product No	Pack
STV971	4

Falcon

- Life-like bird of prey deters other nuisance birds and animals from vulnerable areas
- 14" high with natural colouring



Product No	Pack
STV942	4

Wind Action Owl

- Protects vulnerable garden areas including seedlings from birds
- Wind-activated rotating head and reflective eyes give life-like owl features
- Realistic profile deters birds and nuisance pests from any garden



Product No	Type	Pack
STV965	Single	6
STV965SP	18 Piece Display	1

Owl

- 17" long eared owl acts as an effective deterrent against roosting birds
- Life-like eyes and colouring for maximum impact
- Durable construction of owl fascia
- Can be hung or fixed to hard surface



Product No	Pack
STV966	12

Fly Max Fly Catcher

- 2 re-usable Fly Catcher bottles
- Includes super effective fly attractant
- Flies get in and can't get out
- Outdoor use
- Attracts flies up to 10m radius
- Refills available



Product No	Type	Pack
STV336	Catcher	6
STV337	Refill	6

Fly Max Disposable Fly Trap

- Just add water to activate
- Super effective fly attractant
- Flies get in and can't get out
- Fill it 'n' bin it
- Outdoor use
- Attracts flies up to 10m radius
- Clean and easy disposal



Product No	Pack
STV334	6

Wasp Trap With Bait

- Easy-to-use
- Yellow design to help attract wasps and deter them from other areas of the garden
- Simply mix sachet contents with water
- Unscrew lid for easy emptying and re-using
- Refill with STV371
- Poison-free sachet



Product No	Pack
ZER365	12

Honey Pot Wasp Trap With Bait

- Supplied in variety packs of 6 different colours
- Includes bait sachet
- Redesign of classic favourite to allow easy baiting and safe usage
- Lightweight but strong ABS plastic replaces traditional glass design
- Threaded base-section for easier baiting and clean-up
- Screw-top closure with integral wire hanger



Product No	Type	Pack
STV368	Trap	6
STV371	Refill	6

Wasp Free Zone

- Visual wasp deterrent creates a large wasp free zone without killing wasps
- Natural and effective wasp deterrent
- Wasps assume the territory has already been claimed
- Provides up to 10m radius of wasp-free zone
- Must be hung in plain sight
- 2 pack



Product No	Pack
STV369	6

Big Head Fly Swat

- Mixed pastel colours
- Big head design for increased strike rate
- Square head gets into tight corners
- Tough, polypropylene shaft maximizes swish



Product No	Pack
STV216	36

Bug Bat

- Ideal for camping, BBQs and picnics
- Kills mosquitoes and midges on contact
- Indoor and outdoor use
- Push button activation with on/off indication



Product No	Size	Pack
STV881	Handy	12
STV882	Standard	6

Lantern Bug Zapper

- Kills nuisance biting flies and mosquitoes on contact
- Ideal for BBQs, camping and caravanning
- Suitable for indoor and outdoor use
- Can be used free-standing or hanging
- 4 built-in LED lights
- USB rechargeable battery pack



Product No	Pack
STV887	1

Night Owl Bug Zapper

- Kills nuisance biting flies and mosquitoes on contact via electric grid
- Ideal for summer evenings, BBQs, camping and caravanning
- Most effective in low-light conditions
- Indoor and outdoor use
- Hang or free-stand
- 4 built-in LED lights
- USB rechargeable battery pack



Product No	Pack
ZER888	6

Strip Blind For Doors

- 90cm x 200cm walk-through plastic strips
- Traditional low-cost insect control
- Three mixed colours in every pack
- Easy set up with hang-bar and fixing holes



Product No	Pack
STV235	12

Walk Through Insect Curtain

- Insect curtain with weighted mesh panels which open easily for entry and then swing back into place
- Includes complete installation kit
- Fits any hinged or sliding doorway
- Washable and UV resistant
- Charcoal colour



Product No	Pack
STV231	1

Window Fly Screen

- Fine meshed window screen for an effective barrier against flying insects
- Universal products trim to fit any hinged window measuring 1.3m x 1.5m
- Easy-fit system with hook and loop fixing tape included



Product No	Pack
STV229	6

Magnetic Insect Curtain

- Fine mesh door and window screens form an effective barrier against flying and biting insects
- Easy-fit systems with fixings and full instructions included
- Universal products: can fit any window up to 1.3m x 1.5m or doorway up to 1.0m x 2.1m
- Washable fabric
- UV light resistant



Product No	Type	Pack
ZER236	Doorway	12
ZER234	Window 2 Pack	12

Fly & Wasp Killer Spray

- Kills flies, wasps and biting insects on contact
- Fast acting killer that instantly stops wasps and flies
- Active ingredient is Permethrin Tetramethrin



Product No	Size	Pack
ZER916	300ml	6

Wasp Nest Destroyer Foam

- Home and garden use
- Kills wasps in the nest
- Sufficient for 2-3 treatments
- Contains Permethrin and Teramethrin



Product No	Size	Pack
ZER904	300ml	6

Wasp Nest Killer Powder

- Puffer pack for crack and crevice control of wasps in the nest
- Treat nest in late evening or early morning
- Child resistant cap
- Contains Permethrin



Product No	Size	Pack
ZER910	300g	6

Wasp Killer Kit

- Complete control of wasps around the home, and out in the garden
- Poison-free deterrent and contact killer included
- Kit includes ZER367, ZER910, ZER904, and ZER569



Product No	Pack
COM037	6

Fly Papers

- Kills over 30% more flies than other brands
- Baited with insect attractant
- Clean white paper for indoor and outdoor use
- Traditional, cost effective insect control



Product No	Size	Pack
ZER015	4 pack	24
ZER878	8 pack	12

Kitchen Insect Killer

- Adhesive stick attracts and kills flying insects
- 26cm long
- Aureola yellow colouring attracts flying insects to its long lasting adhesive coating
- Decorative box hides dead flies from sight



Product No	Pack
ZER502	6

90-Day Knockdown Flying Insect Killer

- Discreet adjustable release unit kills and repels flying insects in the home
- Lasts 90 days
- Built-in date reminder slider
- Portable insect control, ideal for holiday travel
- Indoor use
- Covers up to 40m²
- Contains Transfluthrin and Geraniol



Product No	Pack
ZER883	12

Knockdown Mosquito Killer

- Discreet plug-in unit kills mosquitoes and other nuisance flying insects on contact
- Ideal for home, caravan and holiday travel
- Whole room protection
- Lasts up to 360 hours/45 nights
- Refill available
- Contains Prallethrin



Product No	Type	Pack
ZER740	Unit	6
ZER742	Refill	6

High Voltage Insect Killer

- Kills flies, moths and midges
- Collects dead insects hygienically
- Poison-free insect control
- For indoor use



Product No	Pack
ZER880	1

Night Time Insect Killer

- Night-time protection against mosquitoes and other biting insects
- Insects are attracted to the UV LED lights, drawn inside and stick to the adhesive sheets
- Includes 5 adhesive sheets
- Direct indoor plug-in
- Refill available



Product No	Type	Pack
ZER738	Unit	6
ZER737	Refill	6

Fruit Fly Traps

- Non-spill trap discreetly attracts and traps fruit flies
- Non toxic bait solution
- Provides up to 30 days of continuous and discreet control
- Twinpack
- Refill available



Product No	Type	Pack
ZER701	Unit	6
ZER702	Refill	6

NOT FOR SALE IN THE REPUBLIC OF IRELAND

Food & Pantry Moth Traps

- Poison-free protection of food storage and kitchen areas from infestation of pantry moths
- New generation pheromone lure attracts and traps adult moths, their eggs and larvae
- Long lasting – effective for 4-6 weeks
- Easy set-up and discreet protection for kitchens and food storage areas

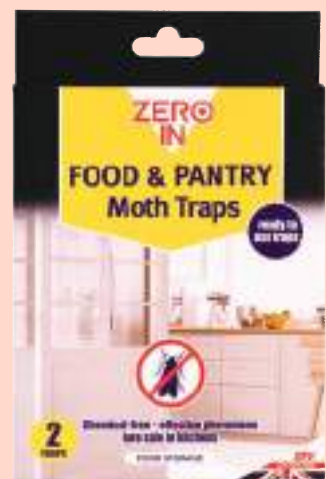

Product No	Pack
ZER711	12

Pot Plant Bug Traps

- Aureola-yellow traps specially designed to attract bugs away from indoor plants
- Clean and easy to use
- UV-light resistant glue stays sticky for months
- Odourless and chemical free



Product No Pack
ZER017 | 12

Pot Plant Bug Sticks

- Aureola-yellow traps specially designed to attract bugs
- Easy to dispose in household waste
- Non-toxic plant protection
- Sticks are made from ethically sourced Bamboo



Product No Pack
ZER018 | 12

60-Day Adjustable Diffuser

- Attractive adjustable release unit
- Citronella fragrance
- Easy twist to open and close
- Portable insect control for holiday travel
- Covers up to 40m²
- Lasts up to 60 days
- Indoor and outdoor use



Product No Pack
ZER885 | 6

30-Day Gel Diffuser

- Can be used in the home and garden
- Harmless to bees and other beneficial insects
- 2 levels of scent release
- Made with natural citronella oil



Product No Pack
ZER871 | 12

30-Day Bamboo Diffuser

- Made from natural bamboo
- Made with natural citronella oil
- Works in any room including offices, caravans, bathrooms
- Harmless to bees and other beneficial insects
- Great for patios and conservatories



Product No Pack
ZER872 | 12

20-Hour Jar Candle

- Use as a stand-alone tabletop candle
- 20 hours burn time
- Made with natural citronella oil
- With wind resistant wick
- Can be used in the home and garden



Product No Pack
ZER875 | 6

Ant & Crawling Insect Killer Spray

- Kills insects on contact
- Residual action against repeat infestations



Product No	Size	Pack
ZER917	300ml	6

Ant Killer Powder

- Controls ants, woodlice, cockroaches, and earwigs
- Puffer pack for crack and crevice treatments around the home
- Treats up to 15m²
- Child resistant cap
- Contains Permethrin



Product No	Size	Pack
ZER964	300g	6
STV950	450g	6

Dual Action Gel Ant Bait

- Baited and ready to use
- Worker ants are attracted to the bait and carry it as food back to their nest, killing the queen and colony
- Enclosed bait protects children and pets



Product No	Pack
ZER965	12

Ant & Cockroach Killer

- 2-in-1 action kills ants and cockroaches and the germs they leave behind
- Odourless treatment ideal for household surfaces
- Water-based formulation – solvent-free
- Contains Cypermethrin and Benzalkonium Chloride



Product No	Size	Pack
ZER958	500ml	6
STV932	1L	6
STV931	1.5L Pressure Sprayer	4

Ant Killer Kit

- Complete Ant Killer Kit
- Kills ants and their nests
- Fast acting contact killers with long-lasting residual action
- Kit includes ZER965, ZER962, and ZER917



Product No	Pack
COM035	6

Total Insect Killer

- Flying and crawling insect control
- Kills most insects on contact
- For indoor use



Product No	Size	Pack
ZER911	300ml	6

Total Household Insect & Germ Killer

- Kills crawling insects and the germs they leave behind
- 2-in-1 action
- Long lasting control
- Ready-to-use formulation for indoor use
- Contains Cypermethrin and Benzalkonium Chloride



Product No	Size	Pack
ZER907	500ml	6

Total Insect Killer Bomb

- Rapid-action knockdown of most flying and crawling insects
- Breaks insect breeding cycle
- Contains Pyrethrins - plant-based ingredients that leave no residues
- For indoor use



Product No	Size	Pack
ZER900	150ml	6

Total Insect & Germ Killer Kit

- Complete Insect & Germ Killer Kit
- 2-in-1 action kills flying and crawling insects and the germs they leave
- Knockdown action as well as long-lasting residual control
- Includes ZER911, ZER907, and ZER900



Product No	Pack
COM032	6

Woodworm Destroyer

- Ready-to-use woodworm treatment protects internal timber, joinery and furniture
- Eradicates and prevents attack by wood-boring beetles
- Micro emulsion formulation allows deep penetration into wood for maximum effectiveness
- Invisible finish, quick-dry formula
- Water-based low odour solution
- Contains Permethrin



Product No	Size	Pack
ZER978	250ml	6
ZER992	500ml	6
ZER993	1L	6

NOT FOR SALE IN THE REPUBLIC OF IRELAND

Bed Bug & Dust Mite Killer Spray

- Treats mattresses, beds and bedroom furniture
- Long-term protection for more than 12 months
- Natural floral fragrance



BEST SELLER

Product No	Size	Pack
ZER968	300ml	12

Bed Bug Killer Spray

- Kills bed bugs and dust mites, and helps prevent allergies
- Water-based treatment for mattresses, beds and household furniture
- Long-lasting, solvent-free odourless treatment
- Contains Cypermethrin



Product No	Size	Pack
ZER983	500ml	6

Bed Bug & Dust Mite Killer Powder

- Treats mattresses, beds and bedroom furniture
- Long-term protection for more than 12 months
- Natural floral fragrance



Product No	Size	Pack
ZER982	250g	6

Bed Bug Traps

- Trap and kill bed bugs discretely and effectively
- Each trap provides up to 60 days protection
- Catches bed bugs at all stages of development
- Poison-free
- 3 pack



Product No	Pack
ZER967	6

Bed Bug & Dust Mite Bomb

- Rapid knock-down and kill of adult and larvae in the home
- Whole-room treatment of up to 40m³ per can
- For use on hard and soft surfaces, including bedding, rugs and carpets
- Cleaner and safer to use than incendiary smoke bombs
- Breaks the breeding cycle and helps reduce re-infestation
- No harmful residues
- Contains natural Pyrethrins



Product No	Size	Pack
ZER984	150ml	6

NOT FOR SALE IN THE REPUBLIC OF IRELAND

Bed Bug Killer Kit

- Complete home protection kit for monitoring and control bed bugs
- Protection of up to 12 months
- Includes Pyrethrins that leave no harmful residues
- Kit includes combination of ZER967, ZER968, and ZER982



Product No	Pack
COM008	6

Carpet Beetle & Moth Killer Spray

- Kills carpet beetles and larvae on contact
- Long lasting protection for up to 12 months
- Treats carpets, upholstery and surfaces where carpet beetles and larvae have been seen
- Contains Permethrin

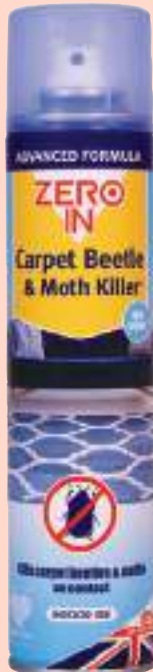

Product No	Size	Pack
ZER977	300ml	6

Carpet Beetle & Moth Killer

- Long-lasting, solvent-free and odourless
- Water-based treatment for household soft furnishings
- With advanced antibacterial action, leaving the treated surface free from germs
- Contains Cypermethrin and Benzalkonium Chloride



Product No	Size	Pack
ZER979	500ml	6

Carpet Beetle & Moth Killer Powder

- Effective control of carpet beetle and moth infestations around the home
- Advanced puffer pack with positive-flow dip tube design to ensure even application rates
- Ideal for crack and crevice treatments and hard to reach areas
- No odours or unpleasant smells
- Contains natural Pyrethrins



Product No	Size	Pack
ZER986	250g	6

Carpet Beetle Killer Strips

- Kills carpet beetles, larvae and eggs
- 20 tear-off strips
- Up to 6 months protection
- Dry treatment – no staining or odour
- Contains Transfluthrin



Product No	Pack
ZER974	12

Carpet Beetle & Moth Bomb

- Rapid knock-down and kill of adult and larvae in the home
- Whole-room treatment of up to 40m³ per can
- For use on hard and soft surfaces, including carpets, rugs and soft furnishings
- Cleaner and safer to use than incendiary smoke bombs
- Breaks the breeding cycle and helps reduce re-infestation
- No harmful residues
- Contains natural Pyrethrins



Product No	Size	Pack
ZER987	150ml	6

Carpet Beetle & Moth Killer Kit

- Complete home protection kit for control of carpet beetles, woolly bears, and their eggs
- Protection of up to 6 months
- Kit includes ZER977, ZER974, and ZER986



Product No	Pack
COM038	6

NOT FOR SALE IN THE REPUBLIC OF IRELAND

Demi-Diamond Clothes Moth Trap

- Uses the latest pheromone technology to protect woollens and natural fibres from moth damage
- Delivers maximum catch rates
- Treats a standard wardrobe area for up to 3 months



Product No	Type	Pack
ZER437	Unit	6
ZER438	Refills	6

Clothes Moth Killer Strips

- Kills moths, their larvae and eggs
- 20 patterned tear off strips
- Up to 6 months protection
- Dry treatment – no drips or stains



Product No	Pack
ZER429	12

Clothes Moth Killer Hanging Unit

- Continuous effective protection against moths, their larvae and eggs for clothes in wardrobes, cupboards and storage areas
- Lasts up to 4 months
- No unpleasant smells, drips or staining
- Contains Transfluthrin and Geraniol



Product No	Type	Pack
ZER432	Single Hook	12
ZER433	Multi-Hook	12

Moth Balls

- New generation moth balls effectively kill moths, larvae and eggs
- Protect clothes in wardrobes, cupboards, drawers and storage
- No fumes, no unpleasant smells, no stains
- Up to 3 months protection
- Contains Transfluthrin



**BEST
SELLER**

Product No	Type	Pack
ZER436	10 pack	6
ZER426	30 pack	6

Cedarwood Moth Balls

- Made from 100% natural Eastern aromatic red cedar for effective, long-lasting, chemical-free control of clothes moths
- Refreshes clothes and helps prevent build-up of mustiness and mildew
- Can be placed in drawers and cupboards
- Fragrance can be refreshed by rubbing with a fine-grade of sandpaper or by using Cedarwood Refresher Spray (ZER039)



Product No	Pack
ZER031	6

Cedarwood Moth Rings

- Made from 100% natural Eastern aromatic red cedar for effective, long-lasting, chemical-free control of clothes moths
- Refreshes clothes and helps prevent build-up of mustiness and mildew
- Can be placed in drawers and cupboards
- Fragrance can be refreshed by rubbing with a fine-grade of sandpaper or by using Cedarwood Refresher Spray (ZER039)



Product No	Pack
ZER035	6

Cedarwood Refresher Spray

- Natural Eastern Aromatic Red Cedar spray refreshes cedarwood products
- Long lasting fragrance in atomising spray dispenser



Product No	Size	Pack
ZER039	75ml	6

Clothes Moth Killer

- Total control – kills clothes moths, their larvae and eggs
- Water-based surface treatment for wardrobes, cupboards and drawers
- Odourless treatment
- Long-lasting protection
- Contains Cypermethrin



Product No	Size	Pack
ZER434	300ml	6

Clothes Moth Killer Spray

- Water-based surface treatment for wardrobes, cupboards and drawers
- Anti-bacterial action, leaving the treated surface free from germs
- Solvent-free, odourless treatment
- Contains Cypermethrin and Benzalkonium Chloride



Product No	Size	Pack
ZER427	500ml	6

Clothes Moth Killer Kit

- Complete home protection kit for control of clothes moths, their eggs and larvae
- Protection of up to 12 months
- Protect valuable fabrics from damage
- Kit includes ZER434, ZER036, ZER432, and ZER436



Product No	Pack
COM039	6

Household Flea Killer Kit

- Complete Household Flea Killer Kit
- Kills cat and dog fleas, as well as their eggs and larvae
- Off-pet treatment
- Whole room treatment of up to 40m³
- Kit includes ZER026, ZER024, and ZER027



Product No	Pack
COM033	6

NOT FOR SALE IN THE REPUBLIC OF IRELAND

Home Flea Powder

- For treatment of living areas including carpets, rugs and soft furnishings
- Shake and vacuum formula absorbs pet odours and leaves living areas with fresh fragrance
- One pack treats up to 10m²
- Kills cat and dog fleas and larvae



Product No	Size	Pack
ZER024	300g	6

NOT FOR SALE IN THE REPUBLIC OF IRELAND

Home Flea Killer Spray

- For treatment of living areas including pet bedding, baskets, cushions and rugs
- Kills cat and dog fleas and larvae
- Not suitable for use on pets, humans or human bedding



Product No	Size	Pack
ZER026	300ml	6

Home Flea Spray

- Kills fleas and larvae on contact
- Water-based treatment for pet bedding, baskets, cushions and rugs
- Odourless
- Long-lasting protection
- Contains Cypermethrin



Product No	Size	Pack
ZER021	500ml	6

Natural Insect Killer Flea Bomb

- Rapid knock-down and kill of adult and larval fleas in the home
- Whole room treatment of all flea harbours - up to 40m³ per can
- For use on hard and soft surfaces, including bedding, rugs and carpets
- Cleaner and safer to use than incendiary smoke bombs
- Breaks the flea breeding cycle and helps reduce re-infestation
- Use to control a wide range of flying and crawling insects in the home
- No harmful residues
- Contains Pyrethrins



Product No	Size	Pack
ZER027	150ml	6

NOT FOR SALE IN THE REPUBLIC OF IRELAND

Flea Killer

- 7w heat lamp mimics warm-blooded animals to attract fleas from bedding and carpets over a 10m radius
- Sticky pad (3 included) acts as an early indicator of flea infestation
- Constant monitor and control of flea problems in home environments
- Refill packs available



Product No	Type	Pack
ZER020	Killer	1
ZER019	Refill	3

Flea Killer Comb

- Safe and effective flea and tick control on cats and dogs
- Kills and removes fleas at adult, egg and larvae stages
- Delivers electrical charge harmless to pets
- Push-button control, ergonomic and fitting design



Product No	Pack
ZER023	3

Spider Repellent

- Ready to use natural formula
- Does not harm spiders
- Spray around windows and doors to create a barrier



Product No	Size	Pack
STV981	500ml	6

NOT FOR SALE IN THE REPUBLIC OF IRELAND

Handy Spider Catcher

- Easy way to remove spiders and insects from the home
- Keeps spiders at a safe distance
- Gentle bristles catch spiders, moths and daddy-long-legs without harm
- Enables catchment in hard to reach areas



Product No	Pack
ZER317	6

Zero In Clipstrips

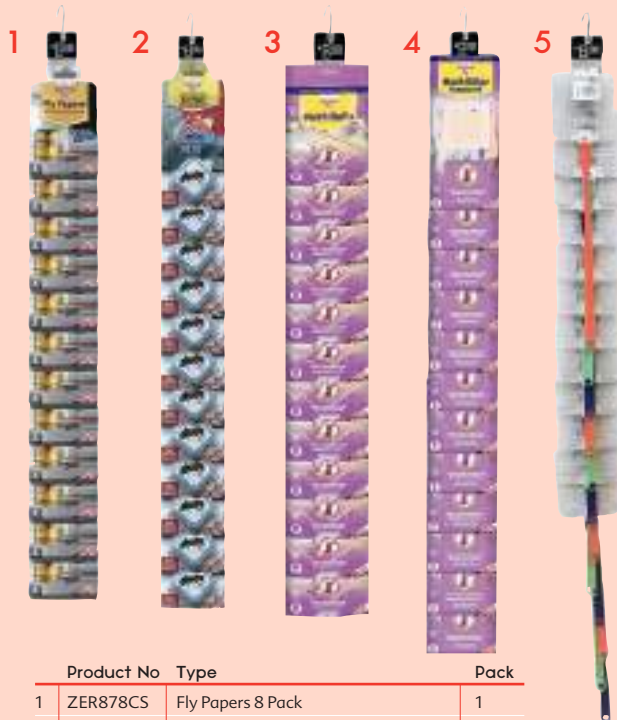

	Product No	Type	Pack
1	ZER878CS	Fly Papers 8 Pack	1
2	ZER965CS	Dual Action Gel Ant Bait	1
3	ZER436CS	Moth Balls 10 Pack	1
4	ZER432CS	Moth Killer Hanging Unit Twinpack	1
5	STV216CS	Big Head Fly Swat	1

Zero In POS Displays

Contact us for details on display fills



Ultra Power Ant & Insect Killer

- Effective, fast acting contact killer of crawling insects, including ants, cockroaches, earwigs, woodlice and silverfish
- Specially formulated to include long-lasting residual action that prevents re-infestation
- Ergonomic trigger handle delivers clean and easy targeted application of insecticide spray
- Contains Tetramethrin and Permethrin



Product No	Size	Pack
ZER554	600ml	6

Ultra Power Fly & Wasp Killer

- Effective knock-down fly and wasp killer, ideal for use in domestic and commercial kitchens and premises alike
- Ergonomic trigger handle delivers clean and easy targeted application of insecticide spray
- Contains Tetramethrin and Permethrin



Product No	Size	Pack
ZER552	600ml	6

Ultra Power Hornet & Wasp Nest Killer Foam

- Foaming wasp nest killer suitable for controlling nests indoors and out
- Spray up to 2 metres for safe application
- Treat nests in early morning or late evening for best results
- Sufficient to kill 4-7 wasps nests
- Contains Tetramethrin and Permethrin



Product No	Size	Pack
ZER556	600ml	6

Ultra Power Household Pest Killer

- Effective, fast-acting contact killer of fleas, bed bugs, clothes moths and other household pests
- Residual action delivers post-treatment control for up to 12 weeks of emerging insect eggs and larvae
- Contains Tetramethrin and Permethrin



Product No	Size	Pack
ZER558	600ml	6

Ultra Power Bed Bug & Dust Mite Killer

- Fast acting formula kills bed bugs and dust mites on contact
- Traditional nozzle, or extended lance spray option ideal for hard to reach areas
- Low odour formulation contains Cyphenothrin and Prallethrin



Product No	Size	Pack
ZER567	500ml	6

Ultra Power Carpet Beetle & Moth Killer

- Fast acting formula
- Traditional nozzle, or extended lance spray option ideal for hard to reach areas
- Low odour formulation contains Cyphenothrin and Prallethrin



Product No	Size	Pack
ZER568	500ml	6

Ultra Power Freeze Spray

- 100% Poison-Free
- Paralyzes insects at -40 degrees
- Precision nozzle and lance ideal for targeting larger individual insects
- Safe for use around food
- Safety lock feature



Product No	Size	Pack
ZER569	500ml	6

Ultra Power Household Germ & Insect Killer

- Kills fleas, bed bugs, clothes moths and other crawling insect pests on contact
- With anti-bacterial additive to prevent the spread of insect germs in kitchens and vulnerable areas
- Accurate and consistent application using pump action pressure spray
- Adjustable nozzle for hard-to-reach areas
- Contains Cypermethrin and Benzalkonium Chloride
- Indoor use



Product No	Size	Pack
ZER550	1.5L	4

Ultra Power Natural Insect Killer Auto Dispenser

- Automatic flying insect killer
- Kill flies, wasps, mosquitoes and other nuisance flying insects
- 24 hour protection
- Contains dispenser and one refill can
- Additional refills available
- Contains natural Pyrethrins



Product No	Type	Pack
ZER562	Dispenser	6
ZER564	Refill	6

NOT FOR SALE IN THE REPUBLIC OF IRELAND

Ultra Power Natural Insect Killer Bomb

- One-shot aerosol bomb delivers rapid knockdown and kill of flies, cluster flies, fleas, bed bugs and other insect pests
- Total room treatment is ideal for indoor living spaces, as well as lofts, outbuildings, stables and poultry houses
- Each aerosol dispenses for 3-4 minutes
- Contains natural Pyrethrins
- 2 pack



Product No	Size	Pack
ZER560	150ml	6

NOT FOR SALE IN THE REPUBLIC OF IRELAND

Ultra Power High Voltage Flying Insect Killer

- Powerful plug-in insect killer
- 2 x 10w UV-A bulbs attract flies, wasps and other nuisance flying insects
- High-voltage 4000v kill grid with insect access from 3 sides
- Eliminates flying insects hygienically and without pesticides
- Removable collection tray for easy cleaning
- Free-standing or hanging use - hanging chain included
- Dimensions: 255mm x 440mm x 90mm



Product No	Pack
ZER570	1

Ultra Power XL Fly Stick

- For summer-long control of flying insects in indoor and sheltered outdoor areas
- Ideal for commercial kitchens, stables, or refuse areas
- Effective control of big fly problems
- Aureola yellow colouring to attract more flies
- Dual use - use with hang hook supplied, or laying on window sills and out of reach areas
- Long-lasting adhesive coating



Product No	Size	Pack
ZER500	60cm	12

Ultra Power Outdoor Fly Trap

- Disposable fly trap
- Holds up to 20,000 flies
- Just add water to activate
- Flies get in and can't get out
- Resealable for extended life
- Outdoor use - attracts flies up to 10m radius and keeps them out of homes and buildings



Product No	Type	Pack
ZER544	Trap	6
ZER546	Refill	6

Ultra Power Ultimate Outdoor Fly Trap

- Giant, reusable fly trap
- Holds up to 60,000 flies
- Includes super effective fly attractant
- Ideal for smallholdings, refuse areas and stables
- Suitable for big fly problems
- Faster catch rate using multiple entry ports
- Outdoor use - attracts flies up to 10m radius
- Refills available



Product No	Type	Pack
ZER540	Trap	4
ZER546	Refill	6

Ultra Power XL Outdoor Fly Trap

- Reusable fly trap catches up to 40,000 flies per fill
- Includes super effective fly attractant
- Ideal for gardens, smallholdings, refuse areas and stables
- Fast catch rates with large 4-way cap entry
- Outdoor use - attracts flies up to 10m radius
- Integrated plastic hanger - hang or stand
- Just add water to activate
- Keeps working for up to 4 weeks
- Refill with ZER546



Product No	Pack
ZER545	6

Ultra Power XL Wasp Trap With Bait

- Includes super-effective wasp attractant
- Made from lightweight and strong plastic
- Twist-on base section for easier baiting, emptying and clean-up
- Integrated plastic hanger
- Refills available



Product No	Type	Pack
ZER565	Trap	6
ZER566	Refill	6



YOUR CASTLE, YOUR HOME

castle-living.co.uk

castle
living[®]
FIRESIDE





Coal Hod

- A stylish and practical solution for storing and transporting coal
- Designed to withstand the demands of daily use, ensuring longevity
- The convenient handle and compact size make it easy to carry and pour coal



Product No	Colour	Size	Pack
CL404722	Black	23cm x 56cm	6
CL404739	Black & Brass	27cm x 54cm	4

Ellipse Coal Hod

- Built to last, ensuring a reliable and long-lasting storage solution
- With a sturdy handle and a wide opening, making it easy to carry and load coal
- A versatile fireside essential that adds both charm and utility to the fireplace



Product No	Size	Pack
CL404746	23cm x 40cm	4

Silver Band Ellipse Coal Hod

- Features a silver band design that adds a touch of elegance
- With a generous capacity, it efficiently holds coal and fuel, keeping the area tidy
- Its sturdy handle and ergonomic design make transporting and loading fuel easy



Product No	Size	Pack
CL404753	25cm x 54cm	1

Antique Brass Band Ellipse Coal Hod

- A stylish and functional addition to any home
- Hand crafted, this coal hod features an elegant antique brass design that adds a touch of sophistication
- With a generous capacity, it provides a convenient and attractive way to store and transport coal



Product No	Size	Pack
CL407914	22cm x 48cm	4

Dimple Ellipse Coal Hod

- A stylish and functional addition to any fireplace or hearth
- Crafted with high-quality materials for durability and longevity
- Features an elegant dimple design and a convenient handle for easy transportation



Product No	Size	Pack
CL404760	26cm x 41cm	1

Stainless Steel Ellipse Coal Hod

- A stylish and durable solution for storing and transporting coal
- Crafted from high-quality steel, this coal hod is built to last, resisting wear over time
- Its ellipse shape provides both functionality and aesthetics, making it a practical addition to any fireplace or stove



Product No	Size	Pack
CL407907	23cm x 41cm	1

Black Coal Bucket & Shovel

- A stylish and functional addition to any fireplace or stove
- Made from high-quality materials, ensuring it can withstand daily use
- Its classic black finish and elegant design make it a perfect complement to both traditional and modern home decor
- The included shovel adds convenience to the set, making it easy to transport and manage coal



Product No	Size	Pack
CL404777	37cm x 34cm	1

Waterloo Coal Bucket

- Crafted with high-quality materials, it's built to withstand daily use
- The generous size and sturdy handle make it easy to transport and store coal



Product No	Size	Pack
CL404784	33cm x 25cm	4

Silver Band Waterloo Coal Bucket

- Features a classic design with a silver band that adds a touch of sophistication
- Its sturdy construction ensures durability, making it perfect for storing and carrying coal for the fireplace or stove



Product No	Size	Pack
CL404791	34cm x 32cm	1

Dimple Waterloo Coal Bucket

- Boasts a durable construction, ensuring it stands the test of time
- The generous size and sturdy handle make it easy to transport and store coal
- Its dimple design and black finish add a touch of sophistication to the hearth



Product No	Size	Pack
CL404807	37cm x 41cm	1

Small Coal Bucket

- A compact and stylish solution for fireplace needs
- Designed to complement any home decor while keeping the fireplace area tidy
- Its convenient size makes it easy to handle, ensuring a hassle-free experience when handling coal or kindling



Product No	Size	Pack
CL404814	29cm x 25cm	4

Coal Bucket & Shovel

- Crafted with durability in mind, this set is made to withstand daily use
- Its generous size ensures storage for an ample supply of coal or wood, reducing the need for frequent refills
- The included shovel adds convenience to the set, making it easy to transport and manage coal



Product No	Size	Pack
CL407921	28cm x 28cm	1

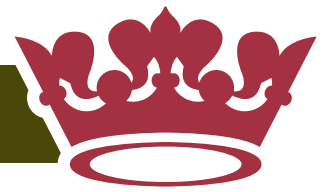

Coal Bucket & Shovel

- Crafted with durability in mind, this set is made to withstand daily use
- Its generous size ensures storage for an ample supply of coal or wood, reducing the need for frequent refills
- The included shovel adds convenience to the set, making it easy to transport and handle coal



Product No	Size	Pack
CL404869	28cm x 31cm	1

Helmet Coal Bucket & Shovel

- Crafted with durable materials and a sleek black finish, this set adds an elegant traditional touch to the home
- Its generous size ensures storage for an ample supply of coal or wood, reducing the need for frequent refills
- The included shovel adds convenience to the set, making it easy to transport and manage coal



Product No	Size	Pack
CL404852	36cm x 34cm	1

Helmet Coal Bucket

- Designed to seamlessly complement traditional home decor while keeping the fireplace area neat and tidy
- Its sturdy construction ensures longevity, while the ergonomic handle provides easy transport and handling of coal or firewood
- Its generous size ensures storage for an ample supply of coal or wood, reducing the need for frequent refills



Product No	Colour	Size	Pack
CL404821	Black	33cm x 29cm	4
CL404838	Black & Chrome	36cm x 28cm	4
CL404845	Black & Brass	34cm x 26cm	4

Premium Coal Bucket & Shovel

- Crafted with high-quality materials, this coal bucket is designed to withstand daily use and provide long-lasting durability
- The set includes a convenient shovel, making it easy to handle and transport coal or other fuels, keeping the fireplace area clean and organized



Product No	Size	Pack
CL404876	28cm x 38cm	1

Wood Pellet Holder

- A stylish and functional storage solution for wood pellets
- Crafted from high-quality steel, this holder adds a touch of elegance to home decor
- A must-have for pellet stove owners



Product No	Size	Pack
CL407952	26cm x 57cm	1

Wood Pellet Dispenser

- Offers convenient and efficient handling of wood pellets
- A perfect addition to any pellet stove, streamlining the reloading process



Product No	Size	Pack
CL407945	11cm x 20cm	8

Ivory Ash Bucket & Lid

- A stylish addition to any fireplace or stove
- Crafted with high-quality materials, this ash bucket and lid offers a tidy ash disposal solution
- The lid keeps ashes contained and out of sight



Product No	Size	Pack
CL404906	34cm x 47cm	4

Black Ash Bucket & Lid

- A stylish addition to any fireplace or stove
- Crafted with high-quality materials, this ash bucket and lid offers a tidy ash disposal solution
- The lid keeps ashes contained and out of sight



Product No	Size	Pack
CL404913	34cm x 47cm	6

Galvanised Ash Bucket & Lid

- A stylish addition to any fireplace or stove
- Crafted with high-quality materials, this ash bucket and lid offers a tidy ash disposal solution
- The lid keeps ashes contained and out of sight



Product No	Size	Pack
CL405903	34cm x 47cm	4

Metal Ash Bucket & Lid

- A functional addition to any fireplace
- Offers a tidy ash disposal solution
- The lid keeps ashes contained and out of sight



Product No	Size	Pack
CL404883	33cm x 43cm	1

Galvanised Ash Box

- A functional addition to any fireplace or stove setup
- Crafted with high-quality materials, this ash box offers a tidy ash disposal solution
- Easy to clean and maintain, this is a must-have accessory for a clean and organized hearth



Product No	Size	Pack
CL404890	47cm x 23cm	1

Black Ash Box

- A functional addition to any fireplace or stove setup
- Crafted with high-quality materials, this ash box offers a tidy ash disposal solution
- Easy to clean and maintain, this is a must-have accessory for a clean and organized hearth



Product No	Size	Pack
CL407938	47cm x 23cm	1

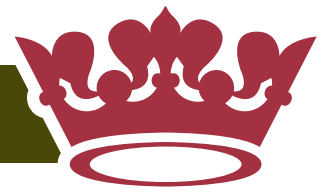

Firelighting Set Grey

- A stylish and functional addition to any home
- Crafted with high-quality materials, this set includes everything needed to start a fire with ease
- The sleek designs and neutral colour make it a perfect fit for any home decor



Product No	Pack
CL406863	1

Ivory Kindling Bucket

- A stylish and practical addition to any fireplace or stove area
- This bucket combines elegance with functionality, making it easy to store and access kindling wood
- Its ivory finish and sturdy handle offer a touch of sophistication, while the durable construction ensures long-lasting use



Product No	Size	Pack
CL404920	47cm x 31cm	4

Kindling Bucket

- A stylish and functional addition to any home's fireplace area
- Crafted with quality materials, this bucket is designed to withstand regular use, ensuring long-lasting durability
- Its spacious capacity makes it perfect for storing and easily accessing kindling
- The ideal accessory for keeping the fireplace well-stocked



Product No	Size	Pack
CL404937	24cm x 21cm	2

Log Splitter

- A powerful and efficient tool designed to make splitting firewood easy
- The product's innovative design ensures safety and precision, reducing the effort required to split logs, and removing the requirement for an axe or other cutting tools



Product No	Pack
CL406924	1

Logs Bucket

- A stylish and functional addition to any home decor
- Crafted from durable materials, this bucket is designed to hold and display firewood attractively
- Its sleek, minimalist design seamlessly blends with various interior styles, adding a touch of elegance to the living space



Product No	Size	Pack
CL404944	34cm x 29cm	2

Circle Design Folding Log Rack

- A stylish and practical solution for organizing and storing firewood
- Crafted with precision, this log rack boasts a circular design that adds a touch of elegance to any living space
- Its folding feature allows for easy storage when not in use, making it a space-saving and convenient addition to the fireplace or wood-burning stove area



Product No	Size	Pack
CL404951	43cm x 33cm	2

Celtic Log Bucket

- This elegantly designed log bucket adds a touch of timeless charm to any fireplace or wood-burning stove setup
- Handcrafted with attention to detail, this log bucket showcases Celtic-inspired aesthetics, making it both a functional and decorative addition to the home
- Constructed from robust materials and finished in classic patina



Product No	Size	Pack
CL406870	54cm	1

Round Log & Kindling Holder

- This sleek and sturdy log holder is perfect for organizing and displaying firewood in style
- This holder not only keeps firewood neatly stored but also adds a touch of elegance to the fireplace or wood-burning stove area
- Crafted with high-quality materials, it is built to withstand daily use and will remain a reliable addition to the home for years to come



Product No	Size	Pack
CL406887	21"/53.5cm	2

Circle Log Holder Pewter

- An elegant and functional addition to any fireplace or hearth, available in a stylish pewter finish
- Available in two sizes, it neatly stores firewood logs, keeping them organized and within easy reach
- Designed to withstand daily use and adds a touch of sophistication to the living space



Product No	Size	Pack
CL406900	Medium 24"/61cm	2
CL406917	Small 20"/52cm	2



Round Rattan Log Basket With Removable Lining

- Crafted from durable rattan, it adds a touch of rustic charm to the living space while helping keep the fireplace area neat and organized
- Features a removable lining for easy cleaning and transport of firewood, making it a practical and convenient choice for homeowners



Product No	Size	Pack
CL406931	50cm x 43cm	10

Rectangle Rattan Log Basket With Wooden Handles

- Crafted from durable rattan and a wooden handle, this basket is both functional and aesthetically pleasing, and features a removable lining for easy cleaning
- Its spacious design ensures ample room for logs, making it a practical and decorative addition to the fireplace area



Product No	Size	Pack
CL406948	58cm x 45cm x 29cm	10

Wheeled Rattan Log Basket With Removable Lining

- Designed to effortlessly transport firewood
- Crafted from durable rattan and features a removable lining for easy cleaning
- With its convenient wheels, moving heavy loads of firewood is made easy, reducing strain and effort for the user



Product No	Size	Pack
CL406955	54cm x 42cm x 51/83cm	5

Round Nested Rattan Log Basket Set of 3

- A stylish and functional addition to any home decor
- Crafted from high-quality rattan, these baskets are not only durable but also add a touch of natural beauty to the living space
- With three different sizes included, this set offers versatility for organizing logs, magazines, or other items, while maintaining a cohesive aesthetic
- With removable lining



Product No	Size	Pack
CL407877	Various	1

Tall Rectangle Rattan Log Basket Set of 2

- Adds a touch of rustic elegance to any living space
- Meticulously handwoven from durable rattan, ensuring both style and longevity
- Perfect for storing firewood, blankets or magazines, these baskets blend seamlessly into various room aesthetics
- With removable lining



Product No	Size	Pack
CL407884	Various	1

Oval Wire Mesh Log Basket With Lining

- With a contemporary oval shape and a durable wire mesh construction, this log basket adds a touch of sophistication
- The removable liner prevents debris from falling out
- Designed for longevity, this log basket is built to withstand the demands of daily use while maintaining its aesthetic appeal



Product No	Size	Pack
CL407105	60cm x 28cm	1

Round Wire Mesh Log Basket With Lining

- Crafted with durable wire mesh, this log basket not only provides a sturdy storage solution for firewood but also adds a touch of rustic charm to the living space
- The removable liner keeps debris contained, making clean-up easy and preserving the cleanliness of the home



Product No	Size	Pack
CL407112	55cm x 28cm	1

Round Wire Log Basket With Rope Handles & Lining

- Featuring sturdy rope handles, this basket is easy to carry and transport firewood, making it a practical choice for the fireplace
- The removable liner prevents debris from falling out



Product No	Size	Pack
CL407129	48cm x 28cm	1

Black Spark Guard

- A must-have fireplace accessory
- Designed to keep embers and sparks safely contained within the fireplace, preventing any potential hazards
- Made from quality materials to withstand the rigors of frequent use



Product No	Size	Pack
CL404999	24"/61cm	10

Dome Spark Guard

- Designed to keep embers and sparks safely contained within the fireplace, preventing any potential hazards
- Made from premium materials, this spark guard enhances the safety of the fireplace and adds a touch of sophistication to the living space



Product No	Size	Pack
CL405002	28"/71cm	4

Heavy Duty Spark Guard

- Crafted with durability in mind, this spark guard effectively prevents embers and sparks from escaping the fireplace
- Its sleek black finish adds a touch of elegance to any hearth, seamlessly blending with various home decor styles
- Made from premium heavy-duty materials



Product No	Size	Pack
CL405019	24"/61cm	4
CL405026	28"/71cm	4

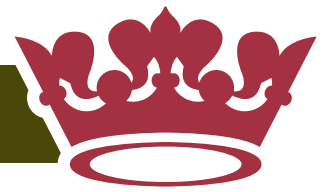

Curved Spark Guard

- Offers stylish protection for the fireplace with its elegant nickel finish and durable construction
- Effectively prevents sparks and embers from escaping, ensuring safety while maintaining a clear view of the fire



Product No	Size	Pack
CL405033	25"/63cm	4

Crest Spark Guard

- Crafted with durability in mind, this spark guard provides essential protection against flying embers and sparks, ensuring a safer and more enjoyable fireside experience
- Its elegant design complements a variety of interior styles



Product No	Size	Pack
CL405040	26.5"/67cm	2

3 Panel Scroll Firescreen

- Crafted with a scrollwork design, this firescreen adds an elegant touch to any living space, seamlessly blending style and functionality
- Built with durable materials, it ensures long-lasting use and effectively shields the home from sparks and embers



Product No	Size	Pack
CL405057	28"/71cm	3

3 Panel Pattern Firescreen

- Featuring a timeless black finish and classic patterned panels, this firescreen adds a touch of sophistication to any home decor
- Crafted with high-quality materials, it offers excellent protection from sparks and embers, ensuring safety while adding charm to the living space



Product No	Size	Pack
CL405064	28"/71cm	3

3 Panel Circle Design Firescreen

- Featuring a timeless black finish and smart circle design panels, this firescreen adds a touch of sophistication to any home decor
- Crafted with high-quality materials, it offers excellent protection from sparks and embers, ensuring safety while adding charm to the living space



Product No	Size	Pack
CL405071	25"/63cm	3

4 Panel Firescreen



Product No	Colour	Size	Pack
21026	Black	32"	3
21028	Black	25"	3
21029	Black	28"	3

Black Nursery Guard

- A versatile and stylish solution for child safety
- Crafted with durable materials and an adjustable design, which fits most fireplaces
- Its sleek black finish complements any decor
- Easy to install and remove, it offers both convenience and peace of mind for parents

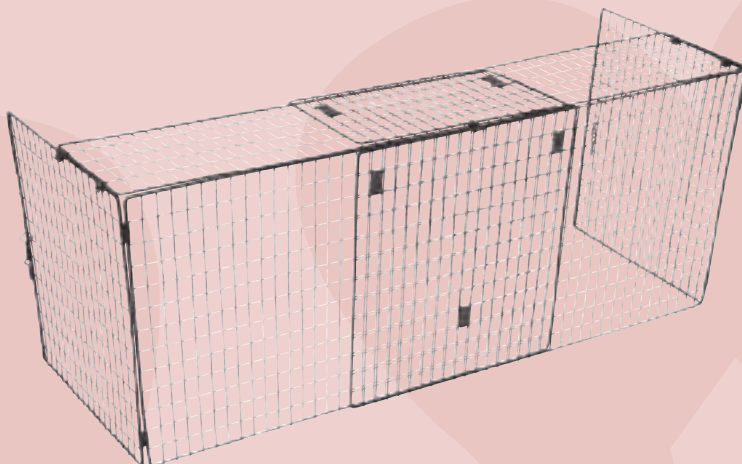

Product No	Size	Pack
CL405088	91-167cm x 66cm	3

Stove Guard

- Ensures protection and safety around wood-burning stoves
- Crafted with high-quality materials, this stove guard is designed to withstand heat
- Its sleek black finish seamlessly blends with any decor while keeping children and pets safe from the stove's hot surfaces
- Easy to install and a must-have accessory for any stove owner

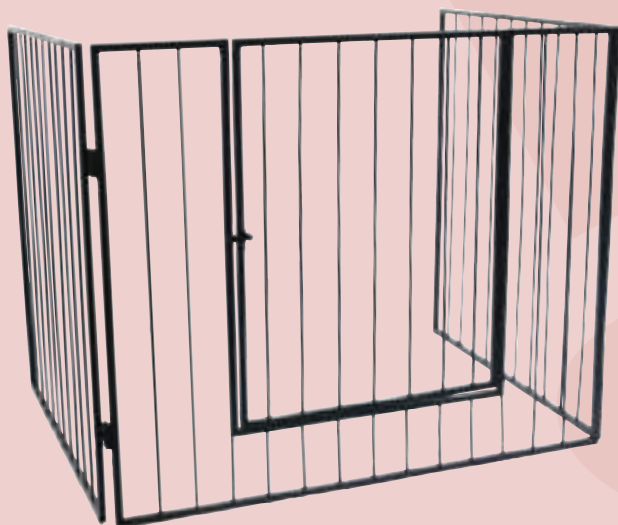

Product No	Size	Pack
CL406788	91cm x 74cm x 76cm	1

Folding Stove Guard

- A must-have safety accessory for every home with a stove, providing peace of mind to families with young children
- Crafted with high-quality materials, this stove guard boasts a durable construction that withstands everyday wear and tear, ensuring long-lasting protection
- Its folding design allows for easy storage when not in use, and it assembles effortlessly to create a sturdy barrier, keeping curious little hands away from hot stoves

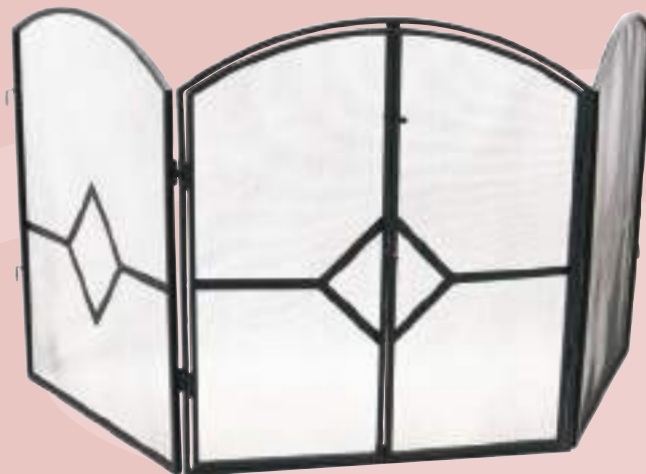

Product No	Size	Pack
CL406795	72cm x 62cm x 80cm	1

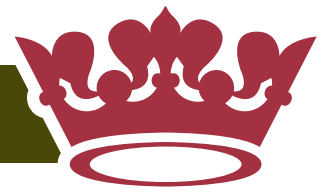

Leather Hearth Tidy

- Crafted from high-quality materials and leather handles, it adds a touch of sophistication to a living space
- Designed to keep the hearth clean and organized, it's both functional and stylish
- A must-have for any modern fireplace



Product No	Pack
CL406818	4

Leather 5 Piece Companion Set

- Crafted from high-quality materials and leather handles for a sleek and sophisticated look
- This set includes all the essential fireplace tools for a fireplace
- With a 28" length, it offers great reach for tending fires



Product No	Size	Pack
CL406801	28"/73cm	4

Leather Magazine Rack

- Crafted from premium leather, it offers both style and durability to any living space
- Provides an elegant storage solution for organized reading materials
- Its smart aesthetic seamlessly complements any interior decor, making it a versatile addition to the home living area or office



Product No	Pack
CL406832	6

Leather Log Bucket

- Crafted from sturdy metal with leather handles, this log bucket is built to last
- With a generous capacity, it can hold a large quantity of logs, making it convenient for keeping firewood neatly organized and easily accessible
- The combination of leather and metal creates a timeless design that seamlessly blends with various home decor styles



Product No	Size	Pack
CL407891	45cm x 35cm	6

Leather Log Holder

- Adds a touch of elegance to any hearth
- Handcrafted with precision, this log holder is made from high-quality materials and a durable leather handle, ensuring a style that will last for years
- It accommodates a generous amount of firewood, keeping logs organized and easily accessible



Product No	Size	Pack
CL406825	17"/43cm	1

Quad 5 Piece Companion Set

- A modern and functional addition to any fireplace
- Hand crafted with attention to detail, this set includes a poker, brush, shovel, and tongs, all elegantly designed in a modern finish
- The tool length ensures safety and ease of use



Product No	Colour	Size	Pack
CL407969	Black	20"/52cm	4
CL407976	Antique Brass	20"/52cm	4

Oblong 5 Piece Companion Set

- The classic oblong design and finish make this set a stylish addition to both traditional and modern home decor
- Hand crafted with attention to detail, this companion set is made to last
- Includes a poker, brush, shovel, tongs, and a stand, making it easy to maintain the fireplace and keep it looking its best



Product No	Colour	Size	Pack
CL407983	Black	31"/79cm	3
CL407990	Antique Brass	31"/79cm	3

Hanging 5 Piece Companion Set

- An exquisite companion set in a modern antique copper finish
- Hand crafted with attention to detail
- Includes a poker, tongs, brush, and shovel, all conveniently hung on a stylish stand
- Adds a touch of sophistication to the living space

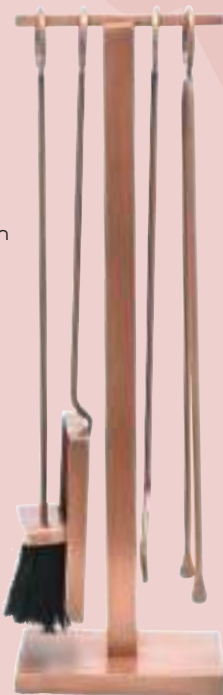

Product No	Colour	Size	Pack
CL408003	Antique Copper	24"/63cm	4

Cement Base 5 Piece Companion Set

- A premium companion set in a modern design
- Crafted with a durable cement base, this set offers both durability and style, making it a perfect addition to any home decor
- The 5-piece set includes a poker, brush, shovel, tongs, and a sturdy base for convenient storage and accessibility



Product No	Colour	Size	Pack
CL408010	Black	24"/61cm	4

Wooden Handle 4 Piece Companion Set

- Crafted with premium quality materials, this set includes a poker, brush, and shovel, all with comfortable wooden handles for a timeless and elegant look
- Keep fireplaces clean and well-maintained with ease, thanks to the stand with an integrated debris tray



Product No	Colour	Size	Pack
CL408027	Black	24"/61cm	1



Loop 5 Piece Companion Set

- A stylish and functional addition to any fireplace
- Crafted from durable steel, this set includes the essential tools for fireplace maintenance
- Featuring a poker, tongs, brush, shovel, and a sturdy stand to keep everything organized and within reach



BEST SELLER

Product No	Colour	Size	Pack
CL405095	Black	24"/61cm	4
CL405101	Black & Nickel	24"/61cm	4
CL405118	Black & Brass	24"/61cm	6

Cube 5 Piece Companion Set

- A smart and stylish solution for organizing fireplace essentials
- Crafted with durability in mind, this set includes a poker, shovel, brush, and tongs, all neatly stored on a sturdy stand
- Seamlessly complements any home decor, adding both functionality and aesthetic appeal to the fireplace area



Product No	Size	Pack
CL405125	23.5"/60cm	6

Gallery 5 Piece Companion Set

- Crafted for both style and functionality, this companion set includes a poker, brush, shovel, tongs, and an elegant stand to keep them organized
- The sleek black finish adds a touch of sophistication to the hearth, while the sturdy construction ensures durability and reliability for years to come



Product No	Size	Pack
CL405132	22"/59cm	6

Fleur De Lys 5 Piece Companion Set

- Features a durable black finish and intricate Fleur De Lys detailing for added charm
- Includes all essential tools for maintaining a fireplace, including a poker, brush, shovel, tongs, and stand



Product No	Size	Pack
CL405149	21"/53cm	6

Basket 5 Piece Companion Set

- A stylish and practical addition to any fireplace
- Crafted with a sleek black finish, this set includes essential tools for maintaining a fire
- The set includes a poker, brush, shovel, tongs, and a stand



Product No	Size	Pack
CL405156	16"/40cm	4

Ball 5 Piece Companion Set

- A stylish and functional addition to any fireplace
- This set includes essential tools for maintaining a fireplace, including a poker, brush, shovel, and tongs, all neatly displayed on a matching stand
- Crafted with durability in mind, the set is made from high-quality materials to ensure long-lasting performance and easy maintenance



Product No	Colour	Size	Pack
CL405163	Black	23"/58cm	4
CL405170	Black & Pewter	23"/58cm	4
CL405187	Black & Brass	23"/58cm	4
CL405194	Pewter	23"/58cm	4

Column 5 Piece Companion Set

- A stylish and practical addition to any fireplace
- Crafted with precision, this set includes a brush, shovel, tongs, and poker, all designed for easy and efficient use
- Its sleek finish adds a touch of elegance to the hearth, making it a perfect blend of form and function



Product No	Colour	Size	Pack
CL405200	Black & Nickel	26"/66cm	4
CL405217	Black & Brass	26"/66cm	4

Orb 5 Piece Companion Set

- A stylish and functional addition to any fireplace or hearth
- Crafted with durability in mind, this set includes a poker, brush, shovel, tongs, and a sturdy stand to keep them organized
- The sleek black finish adds a touch of elegance to the home decor



Product No	Size	Pack
CL405224	16"/40cm	6

Spiral 5 Piece Companion Set

- A stylish and functional addition to any fireplace or hearth
- Crafted in a sleek black finish, this set includes a brush, shovel, poker, and tongs to keep the fireplace clean and well-maintained
- Designed with both beauty and durability in mind, the set features a spiral handle design that adds an elegant touch to the fireplace



Product No	Colour	Size	Pack
CL405231	Black	24"/61cm	4
CL405248	Black & Brass	24"/61cm	4

Curve 5 Piece Companion Set

- A stylish and functional addition to any fireplace or hearth, available in a sleek black finish
- This set includes a poker, brush, shovel, tongs, and a stand for convenient storage
- Crafted with durability in mind, this companion set is built to last, ensuring years of reliable use and making it an excellent investment for the home



Product No	Size	Pack
CL405255	23"/58cm	4

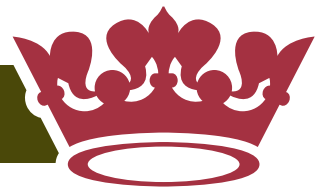

Stainless Steel 5 Piece Companion Set

- A must-have addition to any fireplace, offering both functionality and style
- Crafted from durable stainless steel, this set includes a poker, tongs, brush, shovel, and a stylish stand for easy storage
- Designed for convenience and durability, this companion set is built to withstand the rigors of regular use while adding an elegant touch to the fireplace area



Product No	Size	Pack
CL405262	25"/65cm	6

Hanging 5 Piece Fire Tools Set

- A functional addition to any fireplace or hearth
- Crafted with precision and durability in mind, this set includes a poker, shovel, brush, tongs, and a sturdy hanger for easy access and storage



Product No	Type	Pack
CL405286	Hanger & Tools Set	4
CL405293	Hanger Only	4

Upright Hearth Tidy

- A sleek and stylish addition to any fireplace area
- Crafted with high-quality materials, this tidy offers durability and longevity
- Its upright design saves space and ensures that the tools are within easy reach



Product No	Colour	Pack
CL405309	Black	8
CL405316	Black & Pewter	8

Loop Hearth Tidy

- A stylish and functional addition to any fireplace, designed to keep the hearth area neat and organized
- Crafted with high-quality materials, this hearth tidy features a sleek black finish that complements various home decor styles
- Its loop handle design ensures comfort in use



Product No	Colour	Pack
CL405323	Black	12
CL405330	Black & Brass	12

Ball Hearth Tidy

- A stylish and functional addition to any home fireplace
- Crafted with precision, this hearth tidy combines a classic design with modern durability



Product No	Pack
CL405347	8

Column Hearth Tidy

- A stylish and functional addition to any fireplace
- Crafted with precision, this tidy complements the hearth with its sleek black and nickel finish
- Designed to keep the fireplace area clean and organized, while using minimal space



Product No	Pack
CL405354	8

Poker With Stand

- Designed for both functionality and style
- Crafted from high-quality materials, this poker set ensures durability and reliability
- Its elegant black finish adds a touch of sophistication to any hearth

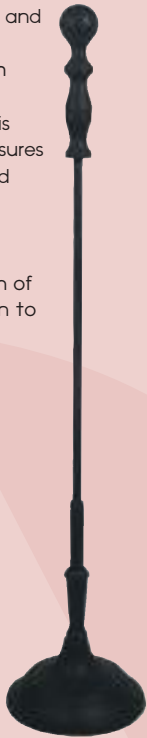

Product No	Size	Pack
CL405385	23"/58cm	12

Twist Poker

Product No	Size	Pack
CL405392	18"/45cm	20

- A timeless addition to any fireplace set
- Crafted with precision and elegance, this poker tool combines functionality with aesthetic appeal
- Its long length ensures safety and convenience when tending to the fire



Black Poker

- A functional fireplace accessory
- Its long length ensures safety and convenience when tending to the fire



Product No	Size	Pack
CL405408	19"/48cm	30

L Rake

Product No	Size	Pack
CL405415	18"/45cm	25

- A versatile tool for fireplace maintenance
- Crafted from durable materials, designed for long-lasting performance
- Effortlessly clean ash and debris from the fireplace with its ergonomic design

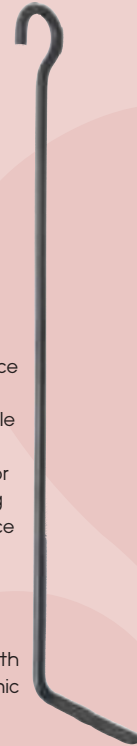

D Rake

- A versatile tool for fireplace maintenance
- Crafted from durable materials, designed for long-lasting performance
- Effortlessly clean ash and debris from the fireplace with its ergonomic design



Product No	Size	Pack
CL405422	18"/45cm	20

Cast Iron Fire Tongs

- Expertly crafted from cast iron
- Built to withstand frequent use
- With a strong grip and precision control, these tongs make it easy to apply fuel to the fire



Product No	Pack
29008	10

Heavy Duty Fire Tongs

- Expertly crafted for safe and efficient fireplace fuel handling
- Made from high-quality materials, these tongs are built to withstand frequent use
- With a strong grip and precision control, these tongs make it easy to arrange fuel and tend to the fire



Product No	Size	Pack
CL405361	15"/38cm	10

Black Fire Tongs

- The essential fireplace accessory
- Made from quality materials, these tongs are designed to withstand daily use, ensuring long-lasting performance
- The handle provides a comfortable grip, making it easy to handle fuel



Product No	Size	Pack
CL405378	12.5"/32cm	20



Twist Shovel

- Enhance the fireplace with this beautifully handcrafted tool, featuring a timeless rope twist design
- Made from high-quality materials, it is built to withstand the demands of regular fireplace use while adding a touch of sophistication



Product No	Size	Pack
CL405439	4"/10cm	20

Black Shovel

- Made from high-quality steel for long-lasting performance
- Its design ensures comfortable handling, making ash removal and fire maintenance easy



Product No	Size	Pack
CL405446	4"/10cm	20
CL405453	5"/12cm	20
CL405460	6"/15cm	10

Wooden Handle Shovel

- Perfect for handling fuel, embers, and ashes, this versatile shovel is an essential addition to any fireplace or wood-burning stove area
- The ergonomic wood handle provides a comfortable and secure grip, ensuring ease of use and preventing hand fatigue during use



Product No	Size	Pack
CL405477	7"/17cm	10
CL405484	9"/22cm	10

Twist Hearth Brush

- Adds elegance and functionality to the hearth
- Handcrafted with precision, it boasts a timeless design and durable build to withstand daily use
- Its natural bristles effortlessly sweep away ash and debris, leaving the hearth clean and inviting



Product No	Size	Pack
CL405491	18"/45cm	20

Red Hearth Brush

- Designed to effortlessly clean ashes and maintain a clean hearth
- The timeless design makes it a stylish addition to the fireplace



Product No	Pack
CL405507	24

Rectangular Hearth Brush Refill

- A convenient replacement for companion set hearth brushes, ensuring that fireplaces are kept clean



Product No	Pack
CL405514	10

Round Hearth Brush Refill

- A convenient replacement for companion set hearth brushes, ensuring that fireplaces are kept clean



Product No	Pack
CL405521	10

Fire Grate

- Made from high-quality iron, this fire grate is built to withstand the rigours of regular use, ensuring long-lasting performance
- Designed with precision, it enhances airflow for a more efficient and controlled burning experience



You may also need...

SEE PAGE 166

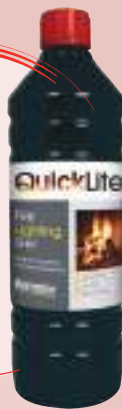

Product No	Size	Pack
CL405538	16"/40cm	2
CL405545	18"/45cm	2

Heavy Duty Fire Grate

- Crafted with durability, this fire grate ensures long-lasting performance, making it a reliable addition to the home
- Its robust construction allows for efficient airflow, promoting a more consistent and efficient burn

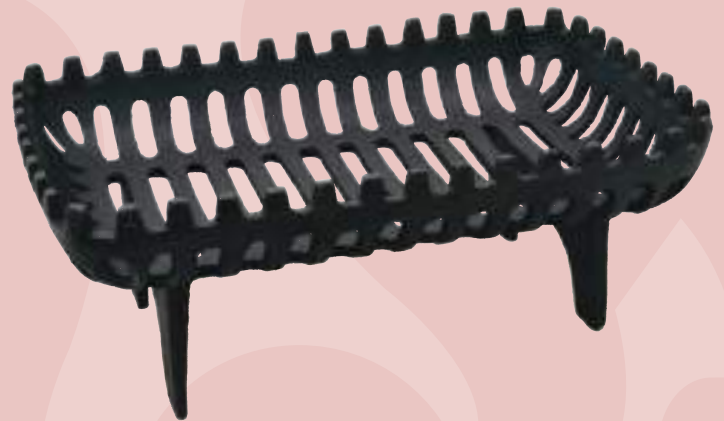

Product No	Size	Pack
CL405552	16"/40cm	1
CL405569	18"/45cm	1

Ash Pan

- A must-have accessory for maintaining a clean and tidy fireplace
- Designed to withstand high temperatures and frequent use, ensuring long-lasting performance
- Its design provides ample space to efficiently collect ashes



Product No	Size	Pack
CL405576	16"/40cm	12
CL405583	18"/45cm	12

Heavy Duty Ash Pan

- Made from high-quality materials, this ash pan is built ensure long-lasting performance
- Its design provides ample space for collecting ash and debris
- Designed for easy and safe collection of ashes, reducing mess and hassle during cleanup



Product No	Size	Pack
CL405590	16"/40cm	12
CL405606	18"/45cm	12

Ash Pan Handle

- Designed to fit a variety of ash pans



Product No	Pack
CL405613	10



Fire Front

- Designed to keep embers safely contained, reducing the risk of accidents
- Crafted from heavy-duty materials and finished in sleek black, it adds protection and also complements the fireplace's aesthetics
- Helps keep the hearth area clean by preventing ash and debris from spilling out, ensuring a tidy and safe fireplace environment



Product No	Size	Pack
CL405620	16"/40cm	4
CL405637	18"/45cm	3

Regal Fire Front

- Crafted from high-quality materials, this fire front offers durability and long-lasting performance
- Designed to keep embers safely contained, it ensures safety while adding a touch of elegance to the hearth

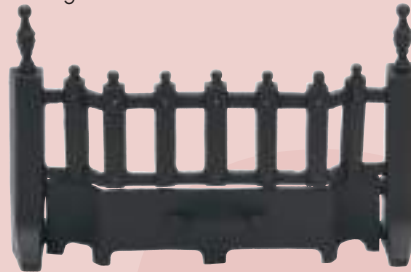

Product No	Size	Pack
CL406849	16"/40cm	1

Regal Fire Starter Set

- Designed for convenience, featuring a 16" (40cm) size to fit most fireplaces
- Crafted with durability in mind, this set includes a sleek black fire front to enhance the fireplace's aesthetics while protecting against falling embers
- The set includes a fire front, grate, ash pan and ash pan handle

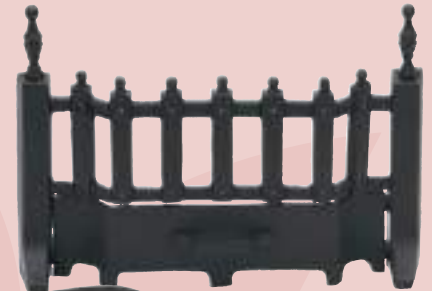

Product No	Size	Pack
CL406856	16"/40cm	4

Coal Saver

- Designed to keep embers safely contained, reducing the risk of accidents
- Helps keep the hearth area clean by preventing ash and debris from spilling out, ensuring a tidy and safe fireplace environment



Product No	Size	Pack
CL405644	16"/40cm	25
CL405651	18"/45cm	25

Ball 3 Piece Fire Fender

Spiral 3 Piece Fire Fender

Product No	Colour	Pack
31004	Black	1



Product No	Colour	Pack
31002	Black	1
31003	Black & Brass	1
31007	Black & Nickel	1

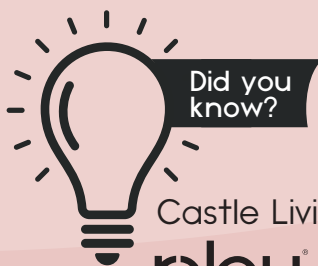

Castle Living is a **relay** brand

Matches & Holder

- Provides a convenient and safe way to store and access matches
- A stylish and functional accessory for any fireplace



Product No	Pack
CL405668	25

Long Matches

- Extended reach reduces the risk of burns and keeps fingers safe from flames
- Each box contains approximately 90 matches

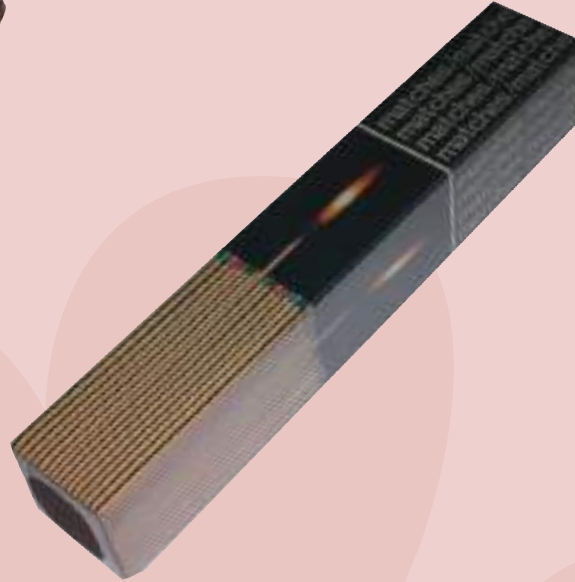

Product No	Size	Pack
CBS2029	11"	16

Long Neck Gas Torch

- Refillable
- Supplied in a display box
- Ideal for lighting fires, gas rings, candles etc.



Product No	Pack
40411182	16

castleliving[®]
 ...at the HEARTH
 of every home



My mats®



A COMPREHENSIVE RANGE OF STYLISH, PRACTICAL & AFFORDABLE MATS

OUR RANGE INCLUDES...

COTTON INDOOR MATS



NYLON INDOOR MATS



STAIN RESISTANT PATTERNED MATS



OUTDOOR



COIR MATS



My Mats® is an exciting range of branded floor and doormats giving you a comprehensive collection to appeal to your customers.

My Mats® is the result of extensive research by Phoenix Textiles who have over 60 years of trusted experience in floor textiles. The range includes all the most popular types of mat in designs and colourways that reflect the latest trends. Create a branded area in your outlet, that customers will find irresistible.

This is a range of very high quality products with all the key features that are normally associated with a higher price point. We've added an attractive brand design to make it even more appealing to your customers and encourage impulse purchase at point of sale. **My Mats®** make commodity products feel energised and exciting, making the consumer feel as if it's been made for them.

– Not just any mats, they're **My Mats®**

...Not just any mats, they're **My Mats®**

BRITISH MANUFACTURED MAT INFORMATION



NYLON INDOOR MAT RANGE...

LONG LASTING: Our nylon tufting is soft, durable and stays looking good for longer. These nylon mats have a high fibre density which makes them extremely resilient, crush resistant and hard wearing – they clean the dirt off your shoes to create the perfect barrier mat. The short cropped pile allows the perfect surface for printing our lovely designs and again is more crush resistant so keeping the mat looking like new.

EASY CLEAN: Nylon is naturally resistant to staining so washing restores the mat, making it look fresh and new time after time. Quick drying enhances the easy care of the mat.

VIBRANT COLOURS: Nylon enhances the mats colours and stays colour fast and vibrant wash after wash.

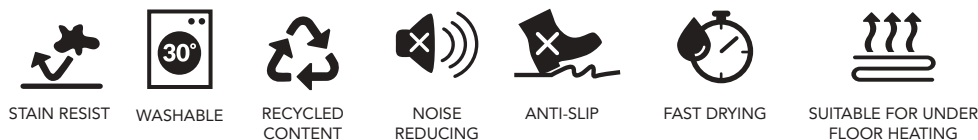

COTTON INDOOR MAT RANGE...

RECYCLED COTTON WITH ADDED MICROFIBRE: Our recycled cotton tufts are mixed with microfibre to create an ultra absorbent mat that traps up to 95% dirt, dust and mud. They are able to absorb up to 3x their own weight in water making them highly efficient at keeping your floors clean.

EASY CLEAN: Washable at 30°C and they get more effective with every wash.

SIMPLE FLECK DESIGN: The cotton mats are made of coloured yarn so keep their colour, the simple fleck design complements any interior also helps to hide dirty marks.



RUBBER BACKING ON NYLON & COTTON...

ANTI-SLIP: Waffle design combined with soft latex rubber allows grip on hard polished surfaces and carpets to stop the mat from slipping or creeping.

ANTI-STAIN: Our stable rubber compound backing is designed not to leave marks, is non-damaging and contains non-staining antioxidants – tested for use on a wide variety of floorings. Our backing is also free from both vinyl and PVC.

RECYCLED CONTENT: Our extra tough membrane that holds the tufts to the backing is made 100% from recycled plastic bottles and we use recycled industrial plastic waste in our rubber backing! Our textile mills in Yorkshire are powered by green energy and are ZERO to landfill!

LONG LASTING: Heavyweight rubber combined with a specially designed extra strong, fibre membrane to bond the fibres to the backing.

MACHINE WASHABLE: Washable at 30°C. Due to the strong bonding layer and the flexible rubber backing the mats can be washed over and over again. The tufted surface becomes more absorbent once washed.

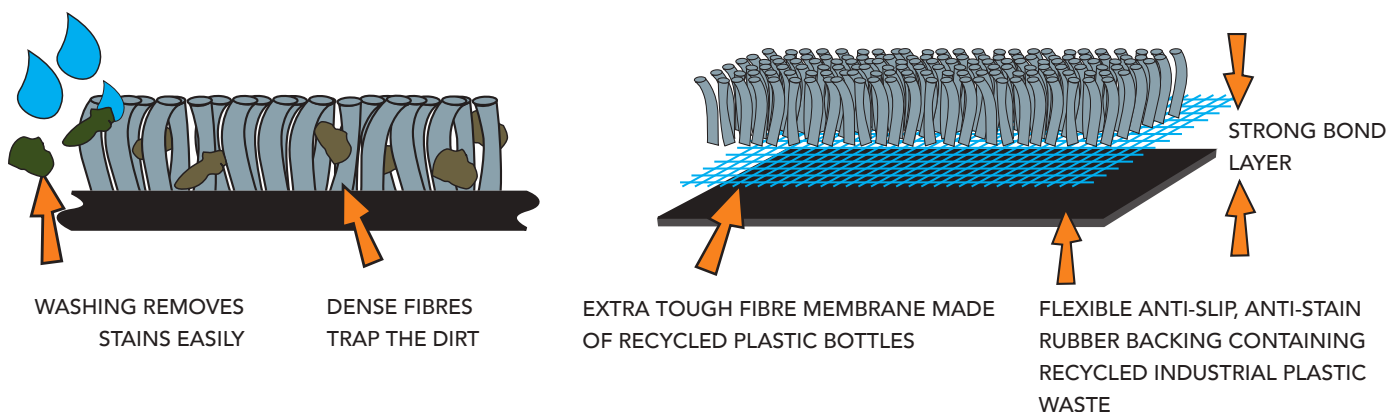

Mymats® WASHABLE COTTON MATS

PLAIN FLECK



Product No	Colour	Size	Pack
PT595934	Sage Green	50cm x 75cm	1
PT595958	Sage Green	80cm x 95cm	1
PT595941	Sage Green	50cm x 150cm	1



Product No	Colour	Size	Pack
PT595972	Terracotta	50cm x 75cm	1
PT595996	Terracotta	80cm x 95cm	1
PT595989	Terracotta	50cm x 150cm	1



Product No	Colour	Size	Pack
PT567979	Indigo	50cm x 75cm	1
PT595910	Indigo	80cm x 95cm	1
PT567986	Indigo	50cm x 150cm	1



Product No	Colour	Size	Pack
PT533448	Linen	50cm x 75cm	1
PT533509	Linen	80cm x 95cm	1
PT533561	Linen	50cm x 150cm	1



Product No	Colour	Size	Pack
PT533431	Coffee	50cm x 75cm	1
PT533493	Coffee	80cm x 95cm	1
PT533554	Coffee	50cm x 150cm	1



Product No	Colour	Size	Pack
PT533462	Slate	50cm x 75cm	1
PT533523	Slate	80cm x 95cm	1
PT533585	Slate	50cm x 150cm	1



Product No	Colour	Size	Pack
PT550605	Charcoal	50cm x 75cm	1
PT550698	Charcoal	80cm x 95cm	1
PT550780	Charcoal	50cm x 150cm	1



ALL COLOURS AVAILABLE AS RUNNERS



COTTON



WASHABLE



ABSORBENT



ECO-FRIENDLY



RECYCLED
CONTENT



NOISE
REDUCING



ANTI-SLIP



SUITABLE FOR UNDER
FLOOR HEATING



PORTLAND STRIPE

CANDY STRIPE & ZIG-ZAG



Product No	Colour	Size	Pack
PT621220	Portland Stripe	50cm x 75cm	1
PT621213	Portland Stripe	80cm x 95cm	1
PT621237	Portland Stripe	50cm x 150cm	1



Product No	Colour	Size	Pack
PT620490	Candy Sage	50cm x 75cm	1
PT620506	Candy Sage	80cm x 95cm	1
PT620483	Candy Sage	50cm x 150cm	1



Product No	Colour	Size	Pack
PT620520	Ribbon Grey	50cm x 75cm	1
PT620537	Ribbon Grey	80cm x 95cm	1
PT620513	Ribbon Grey	50cm x 150cm	1



Product No	Colour	Size	Pack
PT533417	Candy Spice	50cm x 75cm	1
PT533479	Candy Spice	80cm x 95cm	1
PT533530	Candy Spice	50cm x 150cm	1



Product No	Colour	Size	Pack
PT533424	Candy Rock	50cm x 75cm	1
PT533486	Candy Rock	80cm x 95cm	1
PT533547	Candy Rock	50cm x 150cm	1



Product No	Colour	Size	Pack
PT554689	Candy Linen	50cm x 75cm	1
PT554702	Candy Linen	80cm x 95cm	1
PT554726	Candy Linen	50cm x 150cm	1



Product No	Colour	Size	Pack
PT550629	Candy Spice Zig Zag	50cm x 75cm	1
PT550728	Candy Spice Zig Zag	80cm x 95cm	1
PT550810	Candy Spice Zig Zag	50cm x 150cm	1



Product No	Colour	Size	Pack
PT550643	Candy Rock Zig Zag	50cm x 75cm	1
PT550742	Candy Rock Zig Zag	80cm x 95cm	1
PT550834	Candy Rock Zig Zag	50cm x 150cm	1



Product No	Colour	Size	Pack
PT554696	Candy Linen Zig Zag	50cm x 75cm	1
PT554719	Candy Linen Zig Zag	80cm x 95cm	1
PT554733	Candy Linen Zig Zag	50cm x 150cm	1



CANDY SPICE



CANDY ROCK

These are the same as our plain fleck mats but using a range of the coloured fibres tufted together to make stripes and zig zags. The cotton fibres are combined with microfibre to allow even greater dirt trapping ability whilst keeping the natural feel and look of cotton.

My mats® SOFT WASHABLE MATS

PLAIN SOLID COLOUR

These fibres are made of recycled plastic bottles, creating a super soft mat that is washable and stain resistant. The non-slip backing also contains recycled plastic making this an eco-friendly option.



NEW



Product No	Colour	Size	Pack
PT620551	Charcoal	50cm x 75cm	1
PT620568	Charcoal	80cm x 95cm	1
PT620544	Charcoal	50cm x 150cm	1

NEW



Product No	Colour	Size	Pack
PT620582	Clove Brown	50cm x 75cm	1
PT620599	Clove Brown	80cm x 95cm	1
PT620575	Clove Brown	50cm x 150cm	1

NEW



Product No	Colour	Size	Pack
PT620612	Ghost Grey	50cm x 75cm	1
PT620629	Ghost Grey	80cm x 95cm	1
PT620605	Ghost Grey	50cm x 150cm	1

NEW



Product No	Colour	Size	Pack
PT620643	Stone	50cm x 75cm	1
PT620650	Stone	80cm x 95cm	1
PT620636	Stone	50cm x 150cm	1



MADE FROM RECYCLED PLASTIC BOTTLES



WASHABLE



ABSORBENT



ECO-FRIENDLY



NOISE REDUCING



ANTI-SLIP



SUITABLE FOR UNDER FLOOR HEATING

Construction:
Tufted using 100% recycled plastic bottles
Rubber backing containing recycled plastic



My mats® STAIN RESISTANT DURABLE MATS

Stain Resistant Durable Mats – Ultra practical and made with a short loop pile, this great range of interior barrier mats is 100% British made and available at an attractive price point. Stain and bacteria resistant leaving the mats fresher for longer.



NEW



NEW



NAVY
CHARCOAL
STONE

Product No	Colour	Size	Pack	Product No	Colour	Size	Pack	Product No	Colour	Size	Pack
PT620742	Broken Stripe Silver	50cm x 80cm	1	PT620759	Broken Stripe Silver	67cm x 100cm	1	PT620766	Broken Stripe Silver	67cm x 150cm	1
PT620704	Broken Stripe Navy	50cm x 80cm	1	PT620711	Broken Stripe Navy	67cm x 100cm	1	PT620728	Broken Stripe Navy	67cm x 150cm	1
PT620667	Broken Stripe Charcoal	50cm x 80cm	1	PT620674	Broken Stripe Charcoal	67cm x 100cm	1	PT620681	Broken Stripe Charcoal	67cm x 150cm	1
PT620780	Broken Stripe Stone	50cm x 80cm	1	PT620797	Broken Stripe Stone	67cm x 100cm	1	PT620803	Broken Stripe Stone	67cm x 150cm	1



NEW



NEW



IVORY
CHARCOAL
STONE
SILVER

Product No	Colour	Size	Pack	Product No	Colour	Size	Pack	Product No	Colour	Size	Pack
PT620902	Plain Navy	50cm x 80cm	1	PT620919	Plain Navy	67cm x 100cm	1	PT920926	Plain Navy	67cm x 150cm	1
PT620865	Plain Ivory	50cm x 80cm	1	PT620872	Plain Ivory	67cm x 100cm	1	PT620889	Plain Ivory	67cm x 150cm	1
PT620827	Plain Charcoal	50cm x 80cm	1	PT620834	Plain Charcoal	67cm x 100cm	1	PT620841	Plain Charcoal	67cm x 150cm	1
PT620988	Plain Stone	50cm x 80cm	1	PT620995	Plain Stone	67cm x 100cm	1	PT621008	Plain Stone	67cm x 150cm	1
PT620940	Plain Silver	50cm x 80cm	1	PT620957	Plain Silver	67cm x 100cm	1	PT620964	Plain Silver	67cm x 150cm	1



STAIN RESIST



WASHABLE



ABSORBENT



RECYCLED CONTENT



NOISE REDUCING



ANTI-SLIP



FAST DRYING



SUITABLE FOR UNDER FLOOR HEATING

My mats® STAIN RESISTANT DURABLE MATS



Product No	Colour	Size	Pack
PT611108	Arbor Silver	50cm x 80cm	1
PT611368	Arbor Navy	50cm x 80cm	1
PT611320	Arbor Charcoal	50cm x 80cm	1
PT611283	Arbor Stone	50cm x 80cm	1

Product No	Colour	Size	Pack
PT611122	Arbor Silver	67cm x 100cm	1
PT611375	Arbor Navy	67cm x 100cm	1
PT611337	Arbor Charcoal	67cm x 100cm	1
PT611290	Arbor Stone	67cm x 100cm	1

Product No	Colour	Size	Pack
PT611115	Arbor Silver	67cm x 150cm	1
PT611382	Arbor Navy	67cm x 150cm	1
PT611344	Arbor Charcoal	67cm x 150cm	1
PT611306	Arbor Stone	67cm x 150cm	1

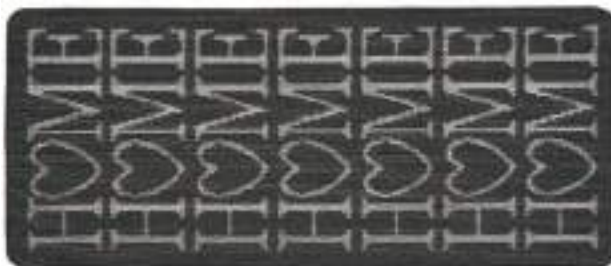

Product No	Colour	Size	Pack
PT544888	Home Charcoal	50cm x 80cm	1
PT604407	Home Navy	50cm x 80cm	1
PT544864	Home Stone	50cm x 80cm	1
PT544871	Home Silver	50cm x 80cm	1

Product No	Colour	Size	Pack
PT539303	Home Charcoal	67cm x 100cm	1
PT604414	Home Navy	67cm x 100cm	1
PT539242	Home Stone	67cm x 100cm	1
PT539273	Home Silver	67cm x 100cm	1

Product No	Colour	Size	Pack
PT539310	Home Charcoal	67cm x 150cm	1
PT604421	Home Navy	67cm x 150cm	1
PT539259	Home Stone	67cm x 150cm	1
PT539280	Home Silver	67cm x 150cm	1



Product No	Colour	Size	Pack
PT611061	Crescent Stone	50cm x 80cm	1
PT611207	Crescent Navy	50cm x 80cm	1
PT611160	Crescent Charcoal	50cm x 80cm	1
PT611245	Crescent Silver	50cm x 80cm	1

Product No	Colour	Size	Pack
PT611085	Crescent Stone	67cm x 100cm	1
PT611214	Crescent Navy	67cm x 100cm	1
PT611177	Crescent Charcoal	67cm x 100cm	1
PT611252	Crescent Silver	67cm x 100cm	1

Product No	Colour	Size	Pack
PT611078	Crescent Stone	67cm x 150cm	1
PT611221	Crescent Navy	67cm x 150cm	1
PT611184	Crescent Charcoal	67cm x 150cm	1
PT611269	Crescent Silver	67cm x 150cm	1





Product No	Colour	Size	Pack
PT604360	Stripe Navy	50cm x 80cm	1
PT544918	Stripe Charcoal	50cm x 80cm	1
PT544895	Stripe Stone	50cm x 80cm	1
PT544901	Stripe Silver	50cm x 80cm	1

Product No	Colour	Size	Pack
PT604377	Stripe Navy	67cm x 100cm	1
PT539396	Stripe Charcoal	67cm x 100cm	1
PT539334	Stripe Stone	67cm x 100cm	1
PT539365	Stripe Silver	67cm x 100cm	1

Product No	Colour	Size	Pack
PT604384	Stripe Navy	67cm x 150cm	1
PT539402	Stripe Charcoal	67cm x 150cm	1
PT539341	Stripe Stone	67cm x 150cm	1
PT539372	Stripe Silver	67cm x 150cm	1



Product No	Colour	Size	Pack
PT546271	Star Stone	50cm x 80cm	1
PT604445	Star Navy	50cm x 80cm	1
PT546356	Star Charcoal	50cm x 80cm	1
PT546318	Star Silver	50cm x 80cm	1

Product No	Colour	Size	Pack
PT546288	Star Stone	67cm x 100cm	1
PT604452	Star Navy	67cm x 100cm	1
PT546363	Star Charcoal	67cm x 100cm	1
PT546325	Star Silver	67cm x 100cm	1

Product No	Colour	Size	Pack
PT546295	Star Stone	67cm x 150cm	1
PT604469	Star Navy	67cm x 150cm	1
PT546370	Star Charcoal	67cm x 150cm	1
PT546332	Star Silver	67cm x 150cm	1



Product No	Colour	Size	Pack
PT552685	Cosy Geo Charcoal	50cm x 80cm	1
PT603288	Cosy Geo Navy	50cm x 80cm	1
PT609211	Cosy Geo Stone	50cm x 80cm	1
PT609242	Cosy Geo Silver	50cm x 80cm	1

Product No	Colour	Size	Pack
PT621275	Cosy Geo Charcoal	67cm x 100cm	1
PT621268	Cosy Geo Navy	67cm x 100cm	1
PT621244	Cosy Geo Stone	67cm x 100cm	1
PT621251	Cosy Geo Silver	67cm x 100cm	1

Product No	Colour	Size	Pack
PT552715	Cosy Geo Charcoal	67cm x 150cm	1
PT603417	Cosy Geo Navy	67cm x 150cm	1
PT609228	Cosy Geo Stone	67cm x 150cm	1
PT609259	Cosy Geo Silver	67cm x 150cm	1



STAIN RESIST



WASHABLE



ABSORBENT



RECYCLED
CONTENT



NOISE
REDUCING



ANTI-SLIP



FAST DRYING



SUITABLE FOR UNDER
FLOOR HEATING

Construction:

Tufts: Polypropylene

Backing: Rubber backing
containing recycled plastic

My mats® WASHABLE PATTERNED NYLON MATS

MAT DESIGNS



Product No	Design	Size	Pack
PT610804	Floral Hedgehog	50cm x 75cm	1



Product No	Design	Size	Pack
PT610897	Butterfly	50cm x 75cm	1



Product No	Design	Size	Pack
PT610880	Flying Ducks	50cm x 75cm	1

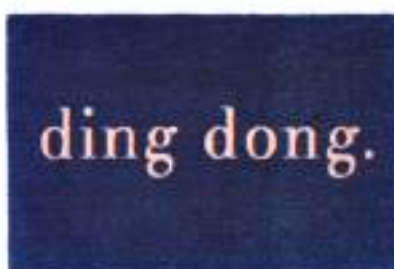

Product No	Design	Size	Pack
PT610767	Ding Dong	50cm x 75cm	1



Product No	Design	Size	Pack
PT610774	Home 3	50cm x 75cm	1



Product No	Design	Size	Pack
PT575264	Sunflowers	50cm x 75cm	1



Product No	Design	Size	Pack
PT593015	Hello	50cm x 75cm	1



Product No	Design	Size	Pack
PT554672	Wellies	50cm x 75cm	1



Product No	Design	Size	Pack
PT603301	Kaleidoscope	50cm x 75cm	1



Product No	Design	Size	Pack
PT593053	Welcome	50cm x 75cm	1



Product No	Design	Size	Pack
PT554665	Home 1	50cm x 75cm	1





MATCHING MATS & RUNNERS

NEW



Product No	Design	Size	Pack
PT621121	Stripe Red	50cm x 75cm	1



Product No	Design	Size	Pack
PT621138	Stripe Red	50cm x 150cm	1

NEW



Product No	Design	Size	Pack
PT621107	Stripe Green	50cm x 75cm	1



Product No	Design	Size	Pack
PT621114	Stripe Green	50cm x 150cm	1

NEW



Product No	Design	Size	Pack
PT621145	Abstract Geo	50cm x 75cm	1



Product No	Design	Size	Pack
PT621152	Abstract Geo	50cm x 150cm	1



STAIN RESIST



WASHABLE



ABSORBENT



RECYCLED
CONTENT



NOISE
REDUCING



ANTI-SLIP



FAST DRYING



SUITABLE FOR UNDER
FLOOR HEATING

Construction:

Tufted 100% Nylon fibres

Backing: Rubber backing
containing recycled plastic

NEW



Product No	Design	Size	Pack
PT621183	Heritage Blue	50cm x 75cm	1



Product No	Design	Size	Pack
PT621190	Heritage Blue	50cm x 150cm	1

NEW



Product No	Design	Size	Pack
PT621183	Heritage Green	50cm x 75cm	1



Product No	Design	Size	Pack
PT621176	Heritage Green	50cm x 150cm	1



Product No	Design	Size	Pack
PT610781	Retro Floral	50cm x 75cm	1



Product No	Design	Size	Pack
PT610798	Retro Floral	50cm x 150cm	1



Product No	Design	Size	Pack
PT610866	Fern Leaves	50cm x 75cm	1



Product No	Design	Size	Pack
PT610873	Fern Leaves	50cm x 150cm	1





Product No	Design	Size	Pack
PT610842	Bluebells	50cm x 75cm	1



Product No	Design	Size	Pack
PT610859	Bluebells	50cm x 150cm	1



Product No	Design	Size	Pack
PT610736	Border Geo	50cm x 75cm	1



Product No	Design	Size	Pack
PT610743	Border Geo	50cm x 150cm	1



STAIN RESIST



WASHABLE



ABSORBENT



RECYCLED
CONTENT



NOISE
REDUCING



ANTI-SLIP



FAST DRYING



SUITABLE FOR UNDER
FLOOR HEATING

Construction:

Tufted 100% Nylon fibres

Backing: Rubber backing
containing recycled plastic

My mats® MATCHING MATS & RUNNERS



Product No	Design	Size	Pack
PT603431	Tribal 1	50cm x 75cm	1



Product No	Design	Size	Pack
PT603448	Tribal 1	50cm x 150cm	1



Product No	Design	Size	Pack
PT603356	Harlequin Tile Blue	50cm x 75cm	1



Product No	Design	Size	Pack
PT603370	Harlequin Tile Blue	50cm x 150cm	1



Product No	Design	Size	Pack
PT603387	Harlequin Tile Green	50cm x 75cm	1



Product No	Design	Size	Pack
PT603400	Harlequin Tile Green	50cm x 150cm	1



Product No	Design	Size	Pack
PT603332	Welcome Hearts	50cm x 75cm	1



Product No	Design	Size	Pack
PT603349	Welcome Hearts	50cm x 150cm	1





Product No	Design	Size	Pack
PT533639	Pheasant	50cm x 75cm	1



Product No	Design	Size	Pack
PT539983	Pheasant	50cm x 150cm	1



Product No	Design	Size	Pack
PT546417	Leaves 2	50cm x 75cm	1



Product No	Design	Size	Pack
PT546424	Leaves 2	50cm x 150cm	1



Product No	Design	Size	Pack
PT572614	Bee 1	50cm x 75cm	1



Product No	Design	Size	Pack
PT572621	Bee 1	50cm x 150cm	1



STAIN RESIST



WASHABLE



ABSORBENT



RECYCLED
CONTENT



NOISE
REDUCING



ANTI-SLIP



FAST DRYING



SUITABLE FOR UNDER
FLOOR HEATING

Construction:

Tufted 100% Nylon fibres

Backing: Rubber backing
containing recycled plastic

My mats® OUTDOOR RANGE

ROPE MATS



Product No	Colour	Size	Pack
PT604568	Black	45cm x 75cm	1
PT604575	Black	60cm x 90cm	1



Product No	Colour	Size	Pack
PT604582	Natural	45cm x 75cm	1
PT604599	Natural	60cm x 90cm	1



Product No	Colour	Size	Pack
PT604605	Navy	45cm x 75cm	1
PT604612	Navy	60cm x 90cm	1

SCRAPER MATS



Product No	Design	Size	Pack
PT567122	Diamond Graphite	45cm x 75cm	1



Product No	Design	Size	Pack
PT601888	Rubber Cross Hatch	45cm x 75cm	1



Product No	Design	Size	Pack
PT531987	Rubber Cast Iron	45cm x 75cm	1



Product No	Design	Size	Pack
PT611009	Fibre Scraper	45cm x 75cm	1



Product No	Design	Size	Pack
PT611016	Ridged Scraper	45cm x 75cm	1

Construction:

Rope Mats – 100% polypropylene

Eco-outdoor – Recycled plastic bottles

Rubber scrapers – 100% rubber

Fibre & Ridged scrapers – Polypropylene with rubber surround and backing

ROPE MAT & ALL SCRAPERS



HARD WEARING



JET WASH



REMOVES MUD

ECO-OUTDOOR



ECO-FRIENDLY



REDUCES BACTERIA



HARD WEARING



JET WASH



REMOVES MUD



REVERSIBLE RUBBER SCRAPER MATS



Product No	Design	Size	Pack
PT611023	Reversible Rubber Zig Zag	45cm x 75cm	1



Product No	Design	Size	Pack
PT611030	Reversible Rubber Curve	45cm x 75cm	1

COIR SCRAPER, PLAIN & CARVED COIR



Product No	Design	Size	Pack
PT531680	Coir Scraper Black	40cm x 60cm	1



Product No	Design	Size	Pack
PT531697	Coir Scraper Natural	40cm x 60cm	1



Product No	Design	Size	Pack
PT567092	Plain Coir	45cm x 75cm	1



Product No	Design	Size	Pack
PT567108	Plain Half Moon	45cm x 75cm	1



Product No	Design	Size	Pack
PT611047	Embossed Curve	45cm x 75cm	1



Product No	Design	Size	Pack
PT611054	Embossed Hello	45cm x 75cm	1



NATURAL
COIR



ECO-FRIENDLY



HARD
WEARING



REMOVES
MUD

Coir Mats – Coir is one of nature's wonder materials, this range takes full advantage of its natural, hard wearing properties. Made from high grade coir, producing less shedding and maximum longevity. They are rot proof and moth proof and fungi resistant.

Coir Construction:

Tufted 100% natural coconut husk fibres
Backing: Coir scrapers are made of rubber, plain and carved coir mats are backed with eco-friendly latex.

My mats® OUTDOOR SURROUNDS & COIR INSERTS

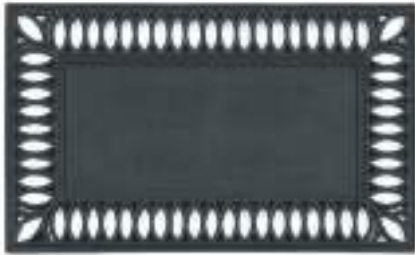

Product No	Design	Size	Pack
PT531666	Castle	45cm x 75cm	1

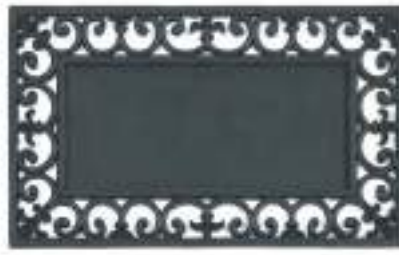

Product No	Design	Size	Pack
PT531673	Marley	45cm x 75cm	1

SURROUNDS – 45cm x 75cm

INSERTS – 23cm x 53cm

NEW



Product No	Design	Pack
PT620100	Bright Tile	1

NEW



Product No	Design	Pack
PT620087	Green Leaves	1

NEW



Product No	Design	Pack
PT620094	Hello	1



Product No	Design	Pack
PT531864	Plain	1



Product No	Design	Pack
PT594692	Daffodil	1



Product No	Design	Pack
PT531901	Welcome	1



Product No	Design	Pack
PT531932	Heart	1



Product No	Design	Pack
PT561694	Buzzy Bee	1



Product No	Design	Pack
PT531925	Pheasant	1



Product No	Design	Pack
PT531871	Stags Head	1



Product No	Design	Pack
PT528918	Star	1



Product No	Design	Pack
PT531918	Lavender	1



Product No	Design	Pack
PT531895	Topiary	1



NATURAL
COIR



ECO-FRIENDLY



HARD
WEARING



REMOVES
MUD

Construction:

Tufted 100% natural coconut husk fibres

Backing: Surrounds are made of rubber, Inserts are backed with eco-friendly latex.



My mats® OUTDOOR PRINTED COIR

A wide range of options available from traditional to fun and contemporary. High quality printing makes the designs long lasting and resistant to fading.



Product No	Design	Size	Pack
PT618992	Bee Happy	45cm x 75cm	1



Product No	Design	Size	Pack
PT619005	Navy Border Stripe	45cm x 75cm	1



Product No	Design	Size	Pack
PT618985	Duck	45cm x 75cm	1



Product No	Design	Size	Pack
PT619036	Bright Ikat	45cm x 75cm	1



Product No	Design	Size	Pack
PT618961	Green Woodblock	45cm x 75cm	1



Product No	Design	Size	Pack
PT619029	Ladybirds	45cm x 75cm	1



Product No	Design	Size	Pack
PT619012	Green Scallop Border	45cm x 75cm	1



Product No	Design	Size	Pack
PT618978	Scroll	45cm x 75cm	1



Product No	Design	Size	Pack
PT610927	Floral Hedgehog	45cm x 75cm	1





OUTDOOR PRINTED COIR



Product No	Design	Size	Pack
PT603059	Hello There	45cm x 75cm	1



Product No	Design	Size	Pack
PT531802	Heart	45cm x 75cm	1



Product No	Design	Size	Pack
PT531727	Wipe Your Paws	45cm x 75cm	1

2 SIZES AVAILABLE



Product No	Design	Size	Pack
PT594661	Daffodil	45cm x 75cm	1



Product No	Design	Size	Pack
PT528901	Star	45cm x 75cm	1



Product No	Design	Size	Pack
PT572591	Inverse Star	45cm x 75cm	1
PT570023	Inverse Star	60cm x 90cm	1



Product No	Design	Size	Pack
PT572539	English Garden 1	45cm x 75cm	1



Product No	Design	Size	Pack
PT572553	English Garden 2	45cm x 75cm	1



Product No	Design	Size	Pack
PT572577	English Garden 3	45cm x 75cm	1



Product No	Design	Size	Pack
PT531772	Pheasant	45cm x 75cm	1

2 SIZES AVAILABLE



Product No	Design	Size	Pack
PT531819	Welcome	45cm x 75cm	1
PT570009	Welcome	60cm x 90cm	1

2 SIZES AVAILABLE



Product No	Design	Size	Pack
PT531826	Buzzy Bees	45cm x 75cm	1
PT570047	Buzzy Bees	60cm x 90cm	1

NEW

BEST SELLER



Product No	Design	Size	Pack
PT546240	Green Border	45cm x 75cm	1
PT619043	Green Border	45cm x 75cm	1
PT570016	Green Border	60cm x 90cm	1
PT619500	Green Border	60cm x 90cm	1
PT546257	Green Border	55cm x 125cm	1
PT619050	Green Border	55cm x 125cm	1

Now all 3 sizes available with green border



Product No	Design	Size	Pack
PT610996	Blues Stripe	45cm x 75cm	1



Product No	Design	Size	Pack
PT610941	Bright Tile	45cm x 75cm	1



Product No	Design	Size	Pack
PT610989	I'm Busy	45cm x 75cm	1



Product No	Design	Size	Pack
PT610972	Icat Blues	45cm x 75cm	1



Product No	Design	Size	Pack
PT610965	Green Leaves	45cm x 75cm	1



Product No	Design	Size	Pack
PT610958	Floral Hello	45cm x 75cm	1



Product No	Design	Size	Pack
PT531833	Stags Head	45cm x 75cm	1



Product No	Design	Size	Pack
PT610910	Hi Bye	45cm x 75cm	1



Product No	Design	Size	Pack
PT610934	Deco	45cm x 75cm	1



Product No	Design	Size	Pack
PT531796	Polka Dots	45cm x 75cm	1



Product No	Design	Size	Pack
PT561656	Geo 1 Triangle	45cm x 75cm	1



Product No	Design	Size	Pack
PT562295	Geo 2 Hexagon	45cm x 75cm	1



Product No	Design	Size	Pack
PT531765	Lavender	45cm x 75cm	1



Product No	Design	Size	Pack
PT531857	Topiary	45cm x 75cm	1

SHEDDING: All coir doormats are made from natural coconut fibres and may shed in the first few months of use. During this period simply brush or shake the mat to maintain its best appearance. **OUTDOOR USE:** If you are using this product outside we recommend that you place your mat in a sheltered area to avoid direct contact with water.



NATURAL COIR



ECO-FRIENDLY



HARD WEARING



REMOVES MUD



Construction:

Tufted 100% natural coconut husk fibres

Backing: Printed coir mats are backed with eco-friendly latex.



MERCHANDISING DISPLAY STANDS

Our display stand collection has been specially created to help you maximise retail floor space, this is enhanced by our bespoke merchandising and display stand, which contains a perfect mix of designs, materials and features. Our displays will let you create a branded area in your outlet that consumers will find irresistible.



MULTI DISPLAY STAND
190cm wide x 80cm deep x 195cm high



4 SIDED STAND
75cm wide x 90cm deep x 249cm high



WATERFALL STAND
66cm wide x 69cm deep x 210cm high



WALL UNITS
125cm wide sections x 67cm deep x 220cm high

Howler & Scratch

PET MAT RANGE



INSPIRED BY OUR LOVE OF PETS



Howler & Scratch WASHABLE PET RANGE

PET MAT RANGE



Product No	Design	Size	Pack
PT610835	Park 1	50cm x 75cm	1



Product No	Design	Size	Pack
PT593824	Going Out 1	50cm x 75cm	1



Product No	Design	Size	Pack
PT593848	Welcome Doggie	50cm x 75cm	1



Product No	Design	Size	Pack
PT519190	Catch 2	50cm x 75cm	1



Product No	Design	Size	Pack
PT538726	Home Paw 1	50cm x 75cm	1



Product No	Design	Size	Pack
PT547117	Wipe Your Paws 1	50cm x 75cm	1

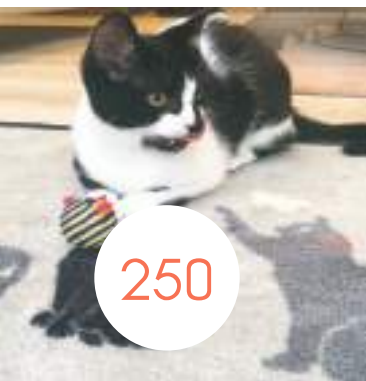



Product No	Design	Size	Pack
PT518254	Big Paws 2	50cm x 75cm	1



Product No	Design	Size	Pack
PT519251	Big Paws 2	50cm x 150cm	1



Product No	Design	Size	Pack
PT518247	Big Paws 1	50cm x 75cm	1



Product No	Design	Size	Pack
PT519244	Big Paws 1	50cm x 150cm	1



Product No	Design	Size	Pack
PT518995	Home 2	50cm x 75cm	1



Product No	Design	Size	Pack
PT519039	Home 2	50cm x 150cm	1



STAIN RESIST



WASHABLE



ABSORBENT



RECYCLED CONTENT



NOISE REDUCING



ANTI-SLIP



FAST DRYING



SUITABLE FOR UNDER FLOOR HEATING

Construction:

Tufted 100% Nylon fibres

Backing: Rubber backing

containing recycled plastic



Piccolo Mail Box

- High-strength plastic mail box
- Anti-UV
- Does not rust
- Waterproof
- Easy maintenance
- Ideal for use in coastal areas
- Dimensions 252mm x 110mm x 377mm



Product No	Colour	Pack
0044007	White	2
0044009	Grey	2
0044003	Green	2

Black Refuse Sack

- Manufactured from reclaimed LDPE
- 50µm and 80µm thickness
- Supplied as a roll
- Each roll individually barcoded
- Each bag is double sealed to help prevent leakage
- Design incorporates unique tie handle

Refuse Sack

- 10 sacks per roll
- Each roll individually barcoded
- With built in tie
- 180 gauge strength

Rubble Sack

- Manufactured from reclaimed LDPE
- 120µm thickness
- Supplied as a roll
- Each roll individually barcoded

Product No	Pack
RS10HD	30



Product No	Size	Weight	Roll Qty	Pack
EL370261	72cm x 110cm	50µm	10	28
EL371749	90cm x 120cm	80µm	6	20

Product No	Size	Weight	Roll Qty	Pack
EL370315	50cm x 80cm	120µm	10	20



relay.global



HOMENEWARE 2024

Astonish SPECIALIST



Award Winning Cleaning Products!
Stock up to Astonish your Sales!



Specialist Kitchen Cleaner

- All round kitchen solution
- Concentrated grease removal formula
- Cuts through grease and dirt quickly and easily
- Leaves surfaces sparklingly clean
- With a zesty Citrus Grove scent



Product No	Size	Pack
C6760	750ml	12

Specialist Antibacterial Surface Cleanser

- For hygienically clean surfaces
- Kills 99.9% of bacteria, effective against e-coli, salmonella and listeria
- With no bleach, no taint and no odour, the product is suitable for use on food preparation areas
- Also ideal for use in fridges, on high chairs, bins and toilets



Product No	Size	Pack
C6700	750ml	12

Specialist Grease Lifter

- With the mighty degreasing power of baking soda
- Fast acting and easy to use
- Simply spray, leave and wipe letting the formula do the hard work
- Ideal for use on baking trays, grill pans, cooker hoods, kitchen surfaces and many more items prone to grease build-ups



Product No	Size	Pack
C6750	750ml	12

Specialist Stainless Steel & Shine

- Removes grease, finger prints and water marks
- Leaves surfaces streak-free and gleaming
- Gentle on polished surfaces
- With a fresh Clear Waters scent
- For use on polished and brushed stainless steel, including fridges, extractor fans and splashbacks



Product No	Size	Pack
C6920	750ml	12

Specialist Multi-Surface Cleaner

- With the added benefit of pure orange oil to power through tough grease deposits and stains
- Use on surfaces around the home where grease gathers, including kitchen surfaces, hobs and oven doors
- Leaves surfaces sparklingly clean
- With a zesty Orange Grove scent



Product No	Size	Pack
C6790	750ml	12

Specialist Window & Glass

- Removes grease, dirt and fingerprints
- Leaves windows streak-free and with a sparkling shine
- Anti-fog technology prevents windows misting up, leaving a crystal clear view



Product No	Size	Pack
C6950	750ml	12

Specialist Mold & Mildew Stain Blaster

- Effectively removes mold and mildew stains in minutes
- No scrubbing required
- The active formula helps prevent return, giving a long-lasting cleaning solution
- Ideal for use on walls, uPVC window frames, glass, plastic shower curtains, bathroom tiles, grout, silicone sealant, concrete, sinks and plugholes



Product No	Size	Pack
C1121	750ml	12

Specialist Multi-Purpose With Bleach

- For use on surfaces all around the home
- With the stain removing power of bleach for helping to remove tough stains
- Leave for a minute to take action before wiping clean to deliver maximum results
- Leaves surfaces hygienically clean



Product No	Size	Pack
C6780	750ml	12

Specialist Bathroom Cleaner

- All over bathroom solution
- Removes soap scum, water marks and limescale
- Cleans to leave a streak-free shine
- With a Fresh Breeze scent
- Ideal for use on baths, wash basins, taps, glazed ceramic tiles and shower heads



Product No	Size	Pack
C6710	750ml	12

Specialist Daily Shower & Shine

- Quick and easy cleaning solution, simply spray and leave, no scrubbing required
- Dissolve soap scum and water marks, leaving a crystal clear shine
- Regular use helps prevent limescale build-up
- Use on plastic and glass screens, enamel trays, tiles and vinyl curtains
- With a fresh Ocean Mist scent



Product No	Size	Pack
C6730	750ml	12

Specialist Ultimate Limescale Remover

- Dissolves limescale, rust and calcium deposits
- Quick and easy to use, no scrubbing required. Simply spray, leave and then wipe clean
- Ideal for hard water areas
- Regular use helps prevent return
- Ideal for problem areas in the bathroom and kitchen including taps, shower heads and sinks
- With a Cool Eucalyptus scent



Product No	Size	Pack
C6940	750ml	12

Specialist Carpet & Upholstery

- Powerful stain remover loosens and lifts away dirt, whilst being gentle on fabrics
- Ideal for accidental spills and spot stain removal on those hard-to-laundry items, such as carpets, curtains and chairs
- The deep cleaning action also works to neutralise unpleasant odours
- Suitable for use on wool and synthetic fabrics



Product No	Size	Pack
C6720	750ml	12

Specialist Machine Carpet Shampoo

- For use with most major carpet cleaning machines
- Powerful cleaning action loosens and lifts away dirt, neutralising unpleasant odours
- Super concentrated, dilute to use



Product No	Size	Pack
C6150	1L	12

Specialist Floor Cleaner

- Removes dirt and grime
- Leaves a brilliant shine
- With advanced dirt repelling technology to leave a protective coating after cleaning, helping to prevent further staining
- Concentrated, dilute to use
- Lavender Blossom fragrance



Product No	Size	Pack
C6110	1L	12

Specialist Hob Cream Cleaner

- An everyday essential
- Removes burnt on spills and dried on food
- Polishes to a sparkling shine
- Leaves a protective coating to help prevent damage from further spillages
- Ideal for use on ceramic, glass induction and halogen hobs as well as microwaves



Product No	Size	Pack
C1089	500ml	6

Specialist Clean & Revive

- Banishes ingrained stains that dishwashing alone leaves behind
- Removes stains and restores items to like new
- Ideal for use on tea and coffee cups, tea pots and flasks
- No scrubbing required
- Simply add one scoop to hot water and watch as the instant foaming action gets to work
- Taint free, leaves no aftertaste



Product No	Size	Pack
C9630	350g	12

Specialist Oven & Grill Cleaner

- Powers through oven dirt, tackling the entire oven including the door
- With the addition of orange oil to cut thorough grease with ease
- Includes a surface specific sponge suitable for doing the job in hand
- With no harsh chemicals there is no need to wear gloves or have a child safety cap unlike many other oven cleaners
- Tried and tested, it's Good Housekeeping Institute approved



Product No	Size	Pack
C8600	250g	6

Multi-Purpose Cleaner With Bleach

- For use on surfaces all around the home, from the bathroom to the kitchen
- With the stain removing power of bleach for when that extra helping hand is needed to remove tough stains
- Kills germs to leaves surfaces hygienically clean
- Leave for a minute to take action before wiping clean to deliver maximum results



Product No	Size	Pack
C1945	750ml	12

Kitchen Cleaner

- All-round kitchen solution
- Cuts through grease and dirt quickly and easily
- Leaves surfaces sparkling clean
- With a Zesty Lemon scent



Product No	Size	Pack
C9618	750ml	12

Mould & Mildew Blaster

- Effectively removes mould and mildew
- Kills 99.9% of bacteria
- No scrubbing required
- The active formula helps prevent return, giving a long lasting cleaning solution
- Ideal for use on walls, uPVC window frames, glass, plastic shower curtains, bathroom tiles, grout, silicone sealant, concrete, sinks and plugholes
- Good Housekeeping Institute approved



Product No	Size	Pack
C9955	750ml	12

Bathroom Cleaner

- All-over bathroom solution
- Removes soap scum, water marks and limescale
- Leaves a streak free shine
- With a fresh pine fragrance
- Ideal for use on baths, wash basins, taps, glazed ceramic tiles and shower heads



Product No	Size	Pack
C9716	750ml	12

Daily Shower & Shine

- Quick and easy cleaning solution, simply spray and leave, no scrubbing required
- Works to dissolve soap scum and water marks leaving a crystal clear shine
- Regular use helps prevent limescale build-up
- Use on plastic and glass screens, enamel trays, tiles and vinyl curtains
- With a fresh Ocean Mist scent



Product No	Size	Pack
C1031	750ml	12

Window & Glass Cleaner

- Removes grease, dirt and finger prints
- With the natural cleaning power of vinegar to leave a crystal clear, streak free shine



Product No	Size	Pack
C1690	750ml	12

Oxy Active Fabric Stain Remover

- A cupboard staple, on hand to remove stains from fabrics instantly, or for treating prior to washing
- Instant stain removal
- Tough on stains, gentle on fabrics
- Recyclable packaging
- Pink Blossom fragrance



Product No	Size	Pack
C9330	750ml	12

Oxy Active Fabric Stain Remover

- Add one scoop to every wash to boost stain removal, remove unpleasant odours and brighten fabrics
- For extra tough stains or to whiten dulled whites use as a pre-treat/soak



Product No	Size	Pack
C1405	625g	12
C1410	1.25kg	6

Protect & Care Laundry Cleanser

- Kills 99.9% of bacteria for confidence that laundry is hygienically clean every time, even at temperatures as low as 20°C
- Freshness all day - prevents malodour on washed clothes left damp in the washing machine, it doesn't just mask malodour but eliminates odour-causing bacteria at the source
- Non-bio



Product No	Size	Pack
C3390	1L	6

Floor Cleaner

- Removes dirt and grime, cleaning to a sparkling shine
- With dirt repelling technology to leave a protective coating after cleaning which helps to prevent further staining
- Concentrated, dilute to use
- Zesty Lemon fragrance



Product No	Size	Pack
C2630	1L	12

Cream Cleaner With Bleach

- A hard working cream cleaner for a deeper clean
- With degreasing agents to cut through tough grease and dirt
- With micro mineral technology: Millions of micro mineral particles built in to help lift dirt away, making tough cleaning jobs easier
- Leaves a sparkling shine



Product No	Size	Pack
C2380	500ml	12

All In 1 Dishwasher Tablets

- Formulated with a powerful cleaning action to remove tough stains including tea, coffee and dried on food
- Built in salt and rinse aid to leave glassware streak free and dishes sparkling
- Suitable for hard water areas
- Phosphate free, which is kinder to the environment
- With a lemon fresh scent



Product No	Size	Pack
C2170	42 Pack	8
C2171	100 Pack	4

Protect & Care Antibacterial Handwash

- Antibacterial to leave hands hygienically clean
- Neutralises malodours
- Ideal for use in food preparation areas
- With added moisturisers to leave hands feeling soft and nourished
- Dermatologically tested, kind to skin
- With added vitamin E for skin repair and protection
- Vegan and cruelty free



Product No	Type	Size	Pack
C4671	Original	600ml	12
C4710	Aloe Vera	600ml	12
C4730	Vitamin E	600ml	12
C4780	Peony Bloom	600ml	12
C4750	Milk & Honey	600ml	12

View more cleaning products on pages 164-166



Stain Remover Powder

- The oldest cleaning product in the USA!
- This high performance powder cleaner uses the natural power of Oxalic acid, found in rhubarb and parsley
- Ideal for cleaning all metals, ceramic surfaces, laminates, tiles, plastics and glass
- It restores heavily stained cookware and also removes rust



Product No	Size	Pack
BK050129	250g	6

Power Cream

- Based on a similar formulation as the famous Stain Remover Powder, the Power Cream is perfect for cookware, metals and ceramics
- Easy to 'squirt' onto vertical surfaces
- Ideal for removing limescale/hard-water stains all around the house



Product No	Size	Pack
BK089594	350ml	6

Power Spray

- Based on the original Bar Keepers Friend blend, Power Spray is for cleaning kitchens, bathrooms and pretty much anywhere a traditional trigger spray cleaner fails
- The foam formulation sticks to vertical surfaces and is excellent for removing limescale, soap-scum and grease



Product No	Size	Pack
BK089617	500ml	6

Sticky Stuff Remover

- Powerful gel spray solution that is ideal for use on vertical surfaces
- Gel consistency clings to the stain on the surface without running off, ensuring the stain can be removed quickly and easily
- Zaps difficult deposits from most surfaces including glass, wood, metal, worktops, fabrics, tiles and much more



Product No	Size	Pack
ZE047844	100ml	12
ZE047844CS	100ml clip strip	12
ZE010312	200ml	6

Universal Stain Remover & Pre-Wash

- Ultimate, all in one solution to eliminate difficult stains on clothing, fabric, furnishings and hard surfaces
- Top selling product with a proven formula
- Easily tackles: tea, coffee, ink, crayon, make-up, tanning lotion, sunscreen, grease, grime, wet paint, mud, grass, blood, wine, wax, adhesives, tar and much more



Product No	Size	Pack
ZE047554	100ml	12
ZE047554CS	100ml clip strip	12



ABSODRY® | duo family
MADE IN SWEDEN



Duo Family Moisture Absorber



Absodry Duo Family is the modern moisture absorber which is aesthetically pleasing and fits in any room - at home or at work. With its minimalist and stylish shape, it gives a modern and decorative impression. It works in silence and is easily emptied of collected water when the indicator shows full.

- Keeps moisture at the right level
- Removes bad odors
- Reduces the risk of mould
- Easy to drain
- Refill available



Duo Family Moisture Absorber Refill

- Refill bag for Duo Family Moisture Absorber
- 600g size
- 2 pack

Our journey towards only using recycled materials begins with the Absodry Duo Family Grey which is manufactured from 100% recycled plastic granulate (PP) (PCR) and the packaging of the Duo Family range is presented in 88% recycled material. This is because we protect the environment and care about the future of our planet.



Product No	Colour	Pack
220-ADB-P	Pink	4
220-ADB-B	Blue	4
220-ADB	Grey	4
220-ADB-G	Green	4

Product No	Size	Pack
205-DFB	600g 2 Pack	8



Classic Moisture Absorber

- Coverage up to 35m³
- Remains efficient for 1-3 months
- For use in homes, caravans, boats, etc



Product No	Size	Pack
200-AD	450g	6

Big Compact Moisture Absorber

- Coverage of 35-80m³
- Remains efficient for 1-3 months
- For use in larger areas, garages, etc



Product No	Size	Pack
214-ADC	1kg	8

Hanger Moisture Absorber

- Coverage up to 35m³
- Remains efficient for 1-3 months
- For use in wardrobes, cars, etc



Product No	Size	Pack
217-AD	450g	12

Moisture Absorber Refill

- Calcium chloride refills
- Unscented
- Fits all AbsoDry absorbers



Product No	Size	Pack
205-AD	450g 3 Pack	8
206-AD	1kg	6

Waffle Dish Cloth

- Premium quality
- Assorted colours
- Check pattern
- 100% cotton
- 35cm x 37cm
- 3 pack



Product No	Pack
108-3R	10

White Dish Cloth

- Absorbent
- Durable
- Ideal for general cleaning tasks
- 30cm x 28cm
- 8 pack



Product No	Pack
DC8	10

Heavy Duty Dish Cloth

- Super absorbent
- Hardwearing
- Made in UK
- 34cm x 30cm
- 3 pack



Product No	Pack
133.12.3RSQ2	10

Multi-Purpose Cloth

- Absorbent cloths which can be used wet or dry
- Can be used to clean windows, cars, kitchens and bathroom surfaces
- 30cm x 38cm
- 8 pack



Product No	Pack
752.8RNSQ2	10

Yellow Duster

- For cleaning and polishing
- 100gsm approx
- 30cm x 33cm
- 8 pack



Product No	Pack
DU8	10

Microfibre Cloth

- Perfect for use around the home or to clean the car
- Removes grease, dust and dirt with ease
- Cleans glass and mirrors to a smear free shine
- No need for chemicals, just use water
- Can be used wet or dry
- 37cm x 37cm
- 3 pack



Product No	Pack
776.3SQ2	10

Microfibre Glass Clean System

- Cleans windows, glass surfaces and mirrors to a smear free shine
- Ideal for use around the home or on the car
- Use the grey cloth damp to remove excess dirt, grime and stubborn marks
- While the surface is still damp, use the mint cloth to wipe the surface to a high shine



Product No	Pack
779.25Q2	10

Check Tea Towel

- Absorbent and durable
- Assorted colours
- 252gsm approx
- 70cm x 45cm
- 3 pack



Product No	Pack
79735Q2	5

Magic Sponge

- Ideal for car interiors
- Removes crayon
- Removes scuff marks, dirt and so much more
- 3 pack



Product No	Pack
891.35Q2	20

Stainless Steel Scourer

- Rust resistant
- Long lasting
- Hygienic
- Use on pots, pans, worktops, ovens, grills and BBQs etc



Product No	Pack
8385Q2	10

Sponge Scourer

- For tough cleaning tasks
- Absorbent sponge
- Abrasive scrim ideal for removing tough stubborn marks
- Made in UK
- 9.6cm x 5.8cm
- 10 pack



Product No	Pack
800105Q2	10

Sure Grip Sponge Scourer

- Specially shaped for extra grip and protection
- Absorbent sponge
- Abrasive scrim ideal for removing tough stubborn marks
- Made in UK
- 8.5cm x 7cm
- 5 pack



Product No	Pack
840.55Q2	10

Super Scourer

- Fantastic cleaning power
- Tough and long lasting
- Ideal for glassware, ovenware and ceramics
- Suitable for non-stick cookware
- 12.5cm x 9.5cm
- 3 pack



Product No	Pack
8375Q2	10

Pearl Scourer

- Gentle, effective cleaning
- Suitable for use on all surfaces
- Will not scratch
- Suitable for non-stick cookware
- 12.5cm x 9.5cm
- 3 pack



Product No	Pack
84935Q2	10

Microfibre Cloth

- Ideal for cleaning glass, mirrors, stainless steel, sanitary ware, car interiors/exteriors, and around the home
- Leaves surfaces smear free
- Highly absorbent and durable
- Environmentally friendly – cleans using only water
- 30cm x 30cm
- 6 pack



Product No	Pack
783AS.6	25

All Purpose Cloths

- Highly absorbent
- Can be used wet or dry
- Ideal for washing up, wiping down and mopping spills
- 60cm x 30cm
- 10 pack



Product No	Pack
747.SC	10

Terry Check Tea Towel

- Assorted colours
- Super absorbent
- Check pattern
- 225gsm approx
- 71cm x 46cm
- Single pack



Product No	Pack
722.1	10

Telescopic Flick Duster

- The dusting fibres statically attract dust and dirt with minimal effort
- The extending handle effortlessly gets into difficult to reach areas
- Handle extends from 83cm to 118.5cm



Product No	Pack
606	10

Bacteria Stop Scouring Sponge

- Sponges contain the addition of Ultra-Fresh DW-30, as a result, they are more hygienic
- Removes stubborn dirt
- Porous sponge provides better foaming
- The sponges remains hygienic for longer due to the blocked development of harmful bacteria up to 99.99%



Product No	Size	Pack
034040	5 Pack	26
034010	10 Pack	18

Bacteria Stop Scouring Sponge For Delicate Surfaces

- Antibacterial metal mesh with silver ions prevents the growth of bacteria on the surface of the product
- Perfect for Teflon, ceramics, glass, enamel, stainless steel and even wood!
- Removes difficult stains from delicate surfaces
- Does not scratch the cleaned surface and does not remove the Teflon layer from dishes



Product No	Pack
032050	36

Bacteria Stop Scrubbing Brush

- Antibacterial bristle and handle pro-actively prevent the growth of bacteria on the surface of the product
- Removes stubborn dirt



Product No	Pack
040040	8

Bacteria Stop Dish Brush

- Antibacterial bristle and handle pro-actively prevent the growth of bacteria on the surface of the product
- The dish brush is recommended for use on dishes and kitchen accessories
- Due to the suitable stiffness of the bristles, it removes stubborn dirt without scratching the surface
- Hygienic handle does not slip out of the hand during use
- The handle has a hole for hanging it on a hook

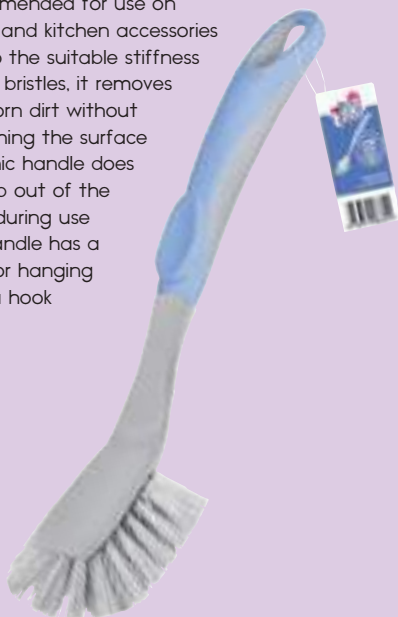

Product No	Pack
041140	18

Bacteria Stop Bottle Brush

- Antibacterial bristle and handle pro-actively prevent the growth of bacteria on the surface of the product
- The optimal length of the brush perfectly removes dirt from up to 1L size bottles and vases
- Hygienic handle does not slip out of the hand during use



Product No	Pack
041100	6

Bacteria Stop Toilet Brush

- Antibacterial bristle and rubber elements on the handle, with the addition of zinc microparticles, pro-actively prevent the growth of bacteria on the product surface
- The rim cleaner feature helps clean underside of rim of toilet
- The thick and specially shaped bristle effectively clean the toilet
- Ergonomic handle, with a special rubber coating, does not slip out of the hand during use



Product No	Pack
064560	12

Bacteria Stop Dustpan & Brush

- Antibacterial bristles, handle and elastomer prevent the growth of bacteria on the surface of the product
- Two types of bristles - thin for sweeping dust and thick for more difficult to clean dirt
- Hygienic, anti-slip handle with a comfortable thumb rest
- The dustpan precisely sticks to the surface thanks to the appropriately shaped rubber
- An eyelet allows for hanging on a hook



Product No	Pack
062070	16

Bacteria Stop Dustpan & Rubber Brush

- Antibacterial bristle, handle and dustpan pro-actively prevent the growth of bacteria on treated surfaces.
- The soft rubber on the brush protects walls and furniture
- Use for sweeping hair and fur from carpets and upholstery
- Special teeth on the dustpan make it easy to remove dirt



Product No	Pack
062060	12

Bacteria Stop Table Brush With Dustpan

- Antibacterial bristle, handle and dustpan prevent the growth of bacteria on the surface of the product
- The soft rubber on the brush protects the surface from scratching
- Thick bristle effectively remove small crumbs without taking the tablecloth off the table
- Innovative design, compact size, convenient storage



Product No	Pack
062110	12

Bacteria Stop Broom

- Antibacterial bristle and handle pro-actively prevent the growth of bacteria on the surface of the product
- Specially selected rubber elements protect furniture and walls from damage
- Two types of bristle - soft to clean dust, hard for stubborn dirt

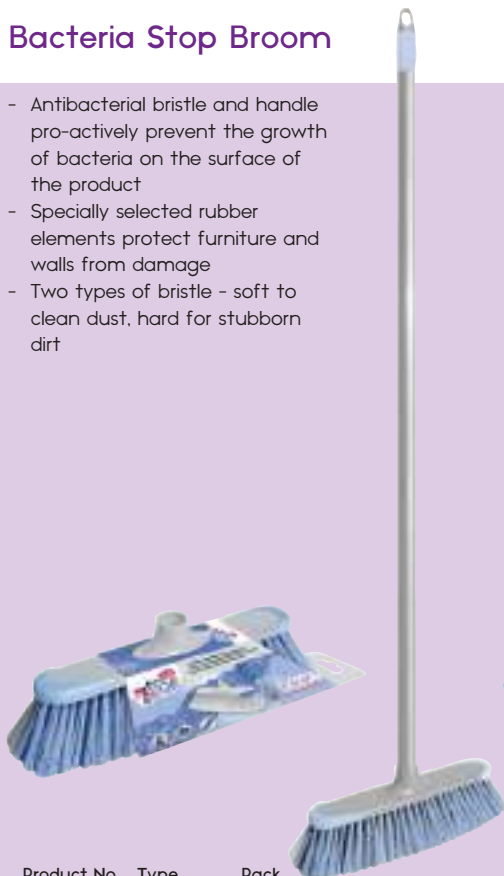

Product No	Type	Pack
050170	Broom	15
051170	Assembled	24

Bacteria Stop Rubber Broom

- Antibacterial bristle and handle pro-actively prevent the growth of bacteria on treated surfaces
- Use for sweeping hair and fur from carpets
- Removal of water from the tiles and panels
- For all types of surfaces
- It is child and allergy sufferer friendly, because does not raise dust

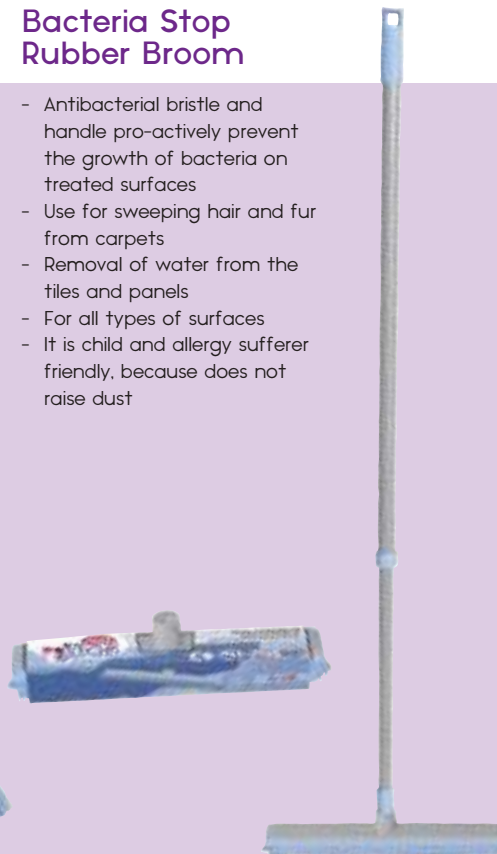

Product No	Type	Pack
050300	Broom	24
051300	Assembled	12

Bacteria Stop Combi Cleaning Set

- Combi set containing Ino. Bacteria Stop Dustpan & Brush and Ino. Bacteria Stop Broom
- Antibacterial bristles and handles pro-actively prevent the growth of bacteria on the surface of the product

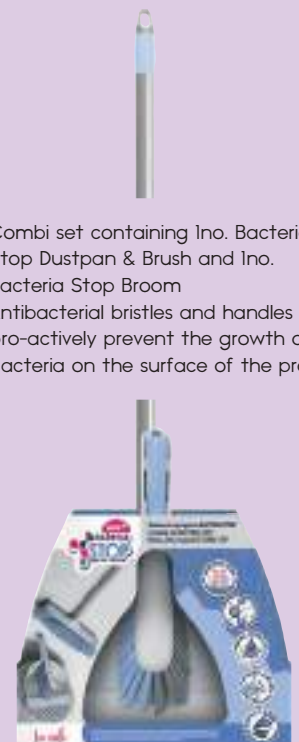

Product No	Pack
082060	8

Bacteria Stop Mop Bucket

- Hygienic and antibacterial handle
- Optimal size, ergonomic shape
- Special handle on the bucket's bottom - facilitates emptying of the bucket
- Equipped with a window and a measure
- Includes wringer with a convenient holder for fixing the handle



Product No	Size	Pack
070000	12L	8

Bacteria Stop Microfibre Mop Head

- Antibacterial mop head with microfibre prevents the growth of bacteria on the surface of the product
- Removes stubborn dirt even without the use of detergents
- The mop is super absorbent due to the microfibre head
- It precisely collects dirt without smearing them on the surface
- The high-strength, antibacterial thread fits all York handles



Product No	Pack
077010	12

Bacteria Stop Flat Spray Mop

- Antibacterial handle and parts prevent the growth of bacteria on the surface of the product
- Comfortable and hygienic floor cleaning without using a bucket
 - a mop and a liquid dispenser in one
- The rotary plate is made of aluminum which makes it easy to reach all nooks and crannies
- Effectively removes bacteria when using disinfectant liquid in the container
- Mop refills available



Product No	Type	Pack
081790	Spray Mop	6
081800	Universal Refill	24
081810	Polishing Refill	24

Bacteria Stop Handles

- Functional handles designed to fit to mop heads and brooms from the Bacteria Stop collection
- With a rotating hole which allows for hanging the handle on a hook

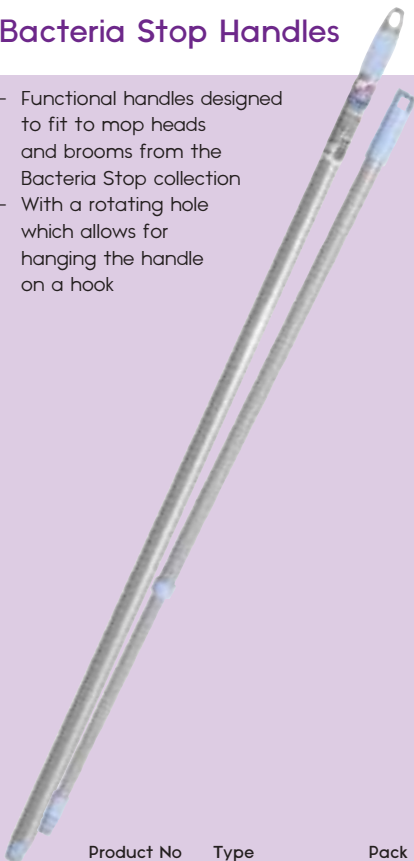

Product No	Type	Pack
091420	120cm	24
091410	140cm Telescopic	30

Bacteria Stop Glass Squeegee

- Essential for washing windows, mirrors and shower enclosures
- The rubber, with a perfect hardness, adheres tightly to the glass surface and removes excess water the first time
- Very comfortable handle made of a special material that prevents it from slipping out of the hand



Product No	Pack
081390	24

Bacteria Stop Glass Cleaning Cloth

- Microfibre fibers contain silver ions, which prevent the growth of bacteria on the surface of the cloth
- Perfect for hygienic wiping, drying and polishing glass
- Ultra-delicate, which guarantees crystal cleanness without streaks or stains
- Leaves a flawlessly shiny surface thanks to the use of innovative weaving technology
- Can be used wet or dry



Product No	Pack
026330	32

Bacteria Stop Display Unit

- Unit contains:
- 6no. Bacteria Stop Table Brush With Dustpan
- 6no. Bacteria Stop Dustpan & Rubber Brush
- 13no. Bacteria Stop Scouring Sponge 5 Pack
- 24no. Bacteria Stop Scouring Sponge For Delicate Surfaces
- 12no. Bacteria Stop Dish Brush
- 24no. Bacteria Stop Scrubbing Brush
- 8no. Bacteria Stop Glass Squeegee
- 5no. Bacteria Stop Microfibre Mop Head
- 8no. Bacteria Stop Mop Bucket 12L
- 14no. Bacteria Stop Bottle Brush
- 6no. Bacteria Stop Rubber Broom With Handle
- 5no. Bacteria Stop Broom With Handle



Product No	Pack
5095030	1

Eco Natural Display Unit

- Unit contains:
- 6no. Eco Natural Bamboo Dustpan & Brush
- 12no. Eco Natural Bamboo Glass Squeegee
- 22no. Eco Natural Scouring Pads 3 Piece
- 30no. Eco Natural Cellulose Scouring Sponge 2 Piece
- 14no. Eco Natural Bamboo Bottle Brush 1L
- 18no. Eco Natural Bamboo Dish Brush
- 12no. Eco Natural Flat Mop Refill
- 18no. Eco Natural Bamboo Scrubbing Brush
- 34no. Eco Natural Garbage Bags With Tie Handle 35L 15 Pack
- 24no. Eco Natural Garbage Bags With Tie Handle 60L 10 Pack
- 6no. Eco Natural Flat Mop
- 4no. Eco Natural Reusable Cotton Cloths 30 Piece Roll
- 5no. Eco Natural Broom With Bamboo Handle 120cm



Product No	Pack
5095000	1

Eco Natural Scouring Pads

- Pad and dishcloth – 2-in-1
- Made from a mixture of natural agave fibers and fibers from processed PET bottles
- Perfectly removes even dried stains from various surfaces
- Cleans without scratches - agave fibers become soft when exposed to water
- 3 pack



Product No	Pack
032040	46

Eco Natural Cellulose Scouring Sponge

- Contains natural cellulose fibres
- Cellulose is a natural, biodegradable fibre sourced from trees. It is one of the most common biopolymers found in nature!
- It will not scratch the surface of dishes
- Also works well without detergents
- The scrubbing side of the sponge is made from 100% recycled materials
- 2 pack



Product No	Pack
035540	28

Eco Natural Scouring Sponge

- This scouring sponge is dedicated for more effective dish and kitchen washing
- The scrubbing side of the sponge is made of agave leaves and other natural fibers (nut shells), and polyester fibers from PET bottles
- Very effective even on residues and dried dirt
- With its durable fibers, it keeps its hygienic properties for longer
- 2 pack



Product No	Pack
030200	28

Eco Natural Reusable Cotton Cloths

- One roll contains 30 soft and durable cloths
- They are made of cotton originating from manufacturing residues, and are not chlorine-whitened
- To re-use, rinse under running warm water and dry
- More economical than paper towels



Product No	Pack
020410	12

Eco Natural Ocean Microfiber Cloth

- Great absorption of moisture
- Can be used without detergents
- Collects dust and effectively cleans mirrors and other glass surfaces
- Can be washed at 40°C
- Extremely durable
- Made from recycled plastic removed from the ocean



Product No	Pack
026240	25

Eco Natural Bamboo Toilet Brush

- With a bamboo handle, which is very durable, and does not absorb moisture
- The bristle is of optimal durability, which effectively removes dirt
- With an extra brush to clean awkward places
- An ecological design
- Made from 85% processed waste



Product No	Pack
064090	8

Eco Natural Bamboo Scrubbing Brush

- The bristle is made from recycled materials (PET)
- With a bamboo handle
- It does not absorb moisture, rot or give unpleasant smells
- Delicate but effective on dried and burnt residues



Product No	Pack
040530	18

Eco Natural Bamboo Dish Brush

- The bristle is made from recycled materials (PET)
- With a bamboo handle
- It does not absorb moisture, rot or give unpleasant smells
- The brush is equipped with a scraper to remove stubborn dirt
- Delicate but effective on dried and burnt residues



Product No	Pack
041130	18

Eco Natural Bamboo Bottle Brush

- With a bamboo handle
- It is gentle on washed surfaces and at the same time effective against soiling and sediments
- It does not accumulate moisture or rot
- Keeps its freshness - does not smell



Product No	Pack
041200	18

Eco Natural Bamboo Dustpan & Brush

- Environmentally friendly materials, modern design, and effectiveness in use!
- A well-shaped bamboo brush
- The bristle made from recycled materials (PET) – densely filled and split at the ends
- The large dustpan lies close to the ground to effectively collect dirt



Product No	Pack
062140	12

Eco Natural Dustpan & Brush

- 100% made of recycled materials
- The brush is made from 1 plastic 500ml bottle and 20 caps
- A simple design and efficient use
- The bristle of the is brush densely embedded and split at the ends made from recycled materials (PET)
- The dustpan lies close to the ground
- Convenient storage, thanks to a special fastening system



Product No	Pack
062160	24

Eco Natural Broom Wood & Coffee With Handle



- The head of broom is a combination of regranulate obtained from processing plastics, polypropylene and WPC with the addition of wood and coffee husks. As a result, the broom is not only environmentally friendly, but also extremely durable
- Bristles are made of rPET material created in the recycling process
- With a 120cm length handle
- Comfortable broom for cleaning dirt and dust

Product No	Pack
052170	20

Eco Natural Broom

- 100% made from recycled materials
- The head of the broom is made from 3 plastic bottles, and the bristles from as many as 51 caps
- Flagged bristles collect more dirt and dust
- With an Italian thread which matches most handles in the market
- Simple, durable, and efficient



Product No	Pack
050280	9

Eco Natural Broom With Handle

- 100% made from recycled materials
- The head of the broom is made from 3 plastic bottles, and the bristles from as many as 51 caps
- Flagged bristles collect more dirt and dust
- Steel reinforced handle in 120cm length
- Useful hole for easier storage
- Simple, durable, and efficient



Product No	Pack
052030	20

Eco Natural Broom With Bamboo Handle

- 100% made from recycled materials
- The head of the broom is made from 3 plastic bottles, and the bristles from as many as 51 caps
- Flagged bristles collect more dirt and dust
- Bamboo handle in 120cm length
- Simple, durable, and efficient



Product No	Pack
052160	20

Eco Natural Bamboo Handle

- 100% made from bamboo
- It does not absorb moisture, rot, or give unpleasant smells
- Optimal length of 120cm
- Italian thread matches most heads in the market
- With a useful hole for easier storage



Product No	Size	Pack
091130	120cm	10

Eco Natural Flat Mop

- Recycling, modern design, and effectiveness in use!
- The mop head is made from recycled cotton
- The plate is made from recycled granulated products
- The handle is made from steel
- The large size of the head means the floor gets cleaned faster
- Can be used wet or dry
- Mop head refills available



Product No	Type	Pack
081670	Complete Mop	12
081680	Mop Head Refill	20

Eco Natural Bamboo Glass Squeegee

- With a bamboo handle
- Instantly removes excess water
- It does not accumulate moisture or rot
- Keeps its freshness - does not smell



Product No	Pack
084340	24

Eco Natural Garbage Bags

- Made of 100% recycled materials
- Available in 2 sizes
- High strength – non-tear
- Easy and convenient tying and disposal, thanks to the special waved edges
- Can be used in round or rectangular base bins, thanks to the use of star welding



Product No	Size	Pack
090050	35L 15 Pack	35
090060	60L 10 Pack	40

Plunger With Plastic Handle

- Extremely functional and solidly made sanitary plunger with a plastic handle
- Helps quickly and effectively clear blockages
- It can be used to clear pipes, sinks and sanitary facilities
- The rubber does not deform
- 120mm diameter



Product No	Pack
097100	30

Plunger With Wooden Handle

- Reliable and durable sanitary plunger with a long wooden handle
- Wooden handle means it does not slip out of the hand during use
- Helpful in clearing sinks and sanitaryware quickly and efficiently
- 150mm diameter



Product No	Pack
097110	30

Wooden Clothes Pegs

- Optimal size, perfect for various types of clothes, both larger and smaller
- Securely protect the laundry from being blown away by the wind
- Simple and versatile vintage design
- Steel spring stabilizes the structure of each peg
- Ecological solution with the environment in mind



Product No	Size	Pack
096050	20 Pack	30

Standard Clothes Pegs

- Durable and solid material with a strong steel clasp can support heavy laundry
- Resistant to weather conditions, therefore they will work well not only inside but also outside the home
- Easy to use



Product No	Size	Pack
096000	20 Pack	30

Extra Clothes Pegs

- Perfect for hanging heavier clothes
- Wide grips make them easier to attach and remove
- Larger size with a steel clasp provide much greater durability
- 4 intense colors bringing energy and freshness
- Suitable for indoor and outdoor use
- Do not leave any unsightly marks on clothes



Product No	Size	Pack
096020	16 Pack	24

Lux Clothes Pegs

- 4 eye-pleasing shades of pink, orange, green and blue
- Resistant to weather conditions
- With solid, steel clips that effectively strengthen the structures of the pegs
- For use at home, on the balcony or in the garden



Product No	Size	Pack
096080	20 Pack	30

Maxi Clothes Pegs

- 4 attractive colors: orange, green, pink and blue
- Resistant to weather conditions
- For internal and external use
- Reinforcement in the form of a steel clip makes the pegs very durable
- Do not leave unsightly marks on clothes



Product No	Size	Pack
096060	20 Pack	30

Marine Clothes Pegs

- Extremely strong and durable due to reinforced materials
- Will hold clothes in place even in the strongest wind
- They can handle thick fabrics
- Soft clips don't leave marks on clothes
- Rubber elements provide a sure grip



Product No	Size	Pack
096030	10 Pack	30

Clothes Line

- Smooth surface of the line covered with a special PP coating makes it easy to keep it clean
- PP core increases the strength of the line
- Flexible material is fully resistant to weather conditions
- The line does not discolor or dye the items hung on it



Product No	Size	Pack
096810	20m	60

Intertwined Clothes Line

- Thanks to the use of PP yarn, the line is very lightweight and can easily be packed for travelling
- Special weave and PP yarn makes the line highly durable
- Does not stain the laundry
- Easy to install



Product No	Size	Pack
096840	20m	60

Reinforced Clothes Line With Metal Core

- The line does not bend under the weight of heavy laundry
- Extremely resistant to weather conditions, does not rust and does not stretch
- Can easily withstand rain, frost or snow
- Special PVC coating protects clothes against dirt or damage



Product No	Size	Pack
096830	20m	45

Clothes Line With Metal Core

- The line does not bend under the weight of heavy laundry
- Extremely resistant to weather conditions, does not rust and does not stretch
- Can withstand rain, frost or snow
- Special PVC coating protects the clothes against dirt or damage
- Easy to install thanks to a special tensioner



Product No	Size	Pack
096820	20m	50

Standard Clothes Hanger

- Universal in use, suitable for hanging scarves, ties or other smaller items of clothing
- Durable plastic firmly holds even heavier clothing
- Correct profiling prevents fabric deformation
- Practical hooks make it easy to hang skirts and dresses so that they do not slide off
- Slightly rough surface prevents clothes from falling off the hanger



Product No	Size	Pack
067090	10 Pack	6

Wooden Clothes Hanger

- Natural, high-quality wood in a light shade
- Special cutouts for easy hanging of skirts, blouses and sweaters
- With a rotating metal handle
- Perfectly handles heavier garments such as winter coats or jackets
- Contoured shape protects clothes against deformation



Product No	Size	Pack
067510	3 Pack	24

Vacuum Storage Box

- The shape of the box makes it easier to pack quilts and pillows
- Enables easy and quick removal of air from the inside of the container with an ordinary vacuum cleaner
- Includes a fragrance sachet
- Extremely durable and strong, reusable material
- Tight zip lock ensures tightness and prevents accidental unsealing of the container



Product No	Size	Pack
093070	60cm x 70cm x 34cm	50
093080	100cm x 80cm x 32cm	50

Hanging Vacuum Storage Bag

- Easy and quick air extraction with a vacuum cleaner
- Extremely strong foil allows the bag to be used multiple times
- Double tight lock effectively protects against any contact with air from the outside
- Practical handle allows for a hanger to be hung with any clothes inside the bag and then attached to the bar in the wardrobe
- Protects clothes against moths, moisture and external odours



Product No	Size	Pack
093040	70cm x 145cm	24

Lint Roller

- Roller consists of 20 sheets with a total adhesive surface of 2.8m
- Easily removes all types of pollen, hair and dust
- Thoroughly removes impurities leaving no traces of glue behind
- Makes refreshing a coat or other clothing easy and convenient
- Perfect for cleaning car upholstery and carpets



Product No	Type	Pack
068000	Lint Roller	24
068020	Lint Roller With 4 Refills	24
068010	Refill 2 Pack	24



DuoFix Ground Screw

Screw in for maximum flexibility!

Multi-purpose miracle DuoFix

The patented DuoFix screw-in ground sleeve offers maximum flexibility in two ways: DuoFix can be easily screwed in and out of the ground without having to be set in concrete, so a change of location for rotary airers, garden parasols, etc. is possible at any time; plus the two sleeves can accommodate all types of round tubes with diameters of 17 to 55 mm.

DuoFix

- ✓ Solid plastic ground anchor
- ✓ Additional plastic coating
- ✓ Includes screw-in rod
- ✓ Suitable for shaft diameters of 17 to 55mm
- ✓ Depth of ground penetration is 48cm
- ✓ Made in Germany

Product No	Pack
33520	10



Idea: The Ultimate Space-Saver

A unique combination of efficiency and ease of use

Unmatched capacity: the Idea clothes dryer offers an impressive line length of 60 meters, capable of accommodating up to six loads of washing. It's hard to match its laundry capacity.

Comprehensive set: this set includes a protective cover and a ground socket for convenient screw-in installation, providing all that's required for rapid set-up and use.

Effortless operation: like all Blome rotary clothes dryers, the Idea model is both robust and user-friendly. It can be effortlessly opened and closed with just one hand, while also having the flexibility to continuously adjust the desired height. Hanging and removing laundry is a breeze as the Idea can be freely rotated to your preferred position. Furthermore, it features a windproof hanger holder that can secure up to twelve clothing hangers.

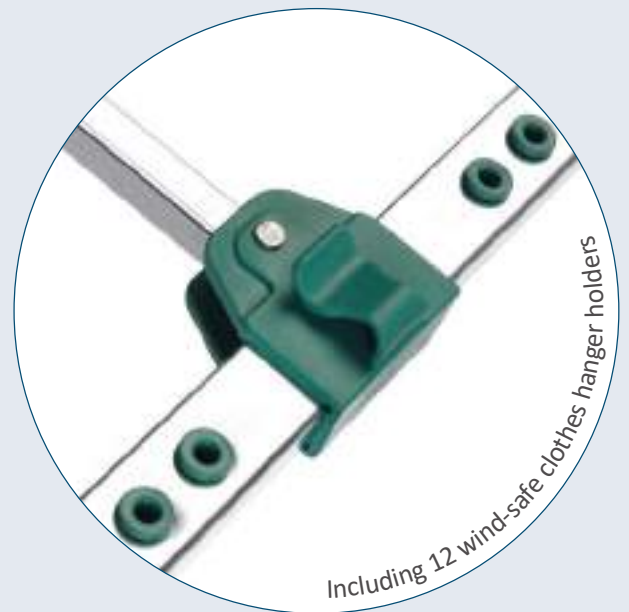
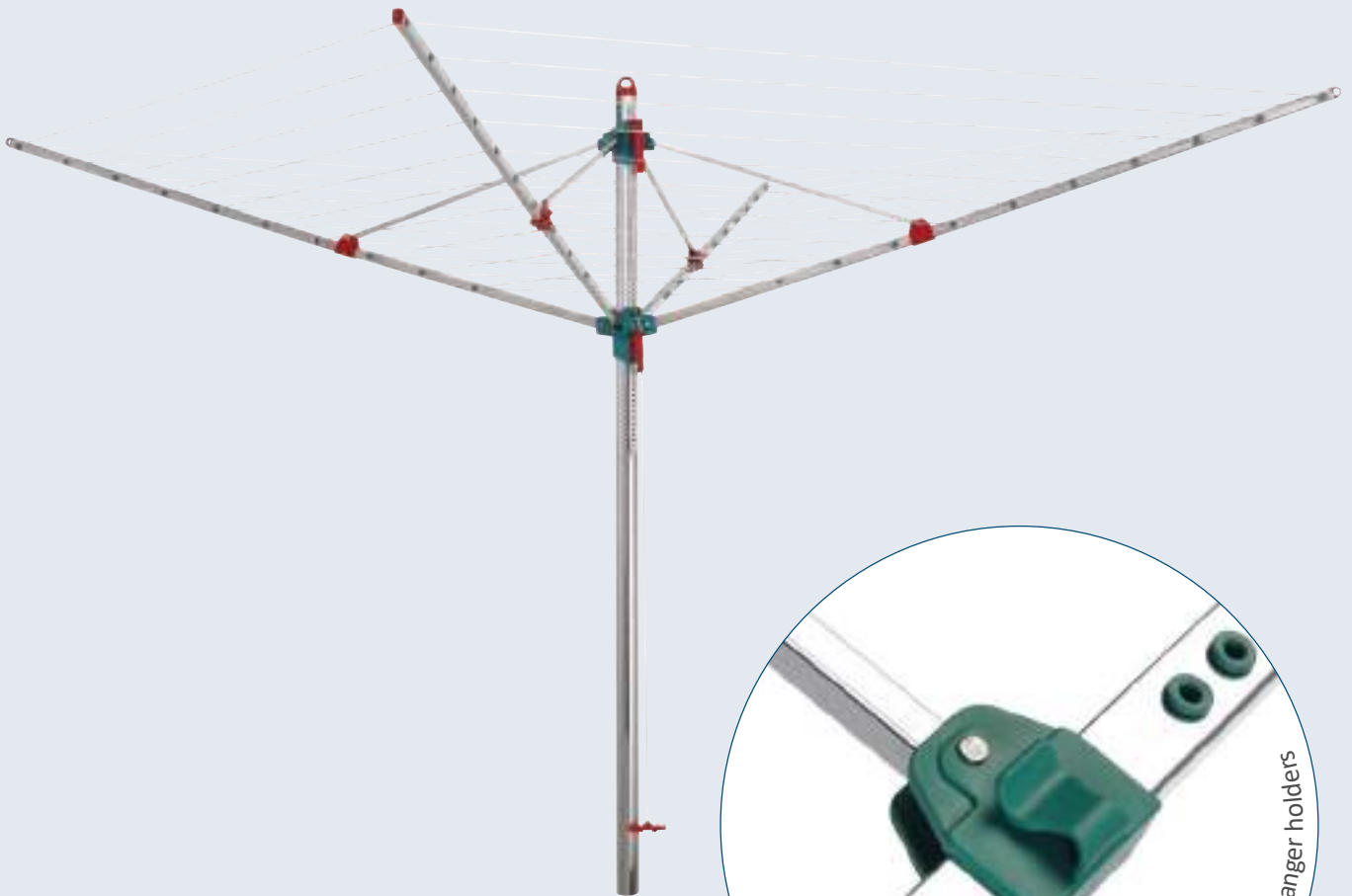

- ✓ Impressive 60-meter line length

- ✓ Resistant to weather and UV exposure

- ✓ Effortless, stepless height adjustment through cable pull and grid technology

- ✓ Sturdy aluminium standpipe with a diameter of 50mm

- ✓ Support arms constructed from high-quality aluminium rectangular profiles, with star components made from recyclable plastic

- ✓ Includes a screw-in ground sleeve for secure installation

- ✓ Complete with a protective zip case

- ✓ 3 year guarantee

- ✓ Proudly manufactured in Germany



Display stand available
- contact us for details

Product No	Size	Pack
81065	4 Arm 60m	10



Alustar: Simple. Affordable. Effective.

A robust entry-level aluminum rotary clothes dryer

This weather and UV-resistant rotary clothes dryer boasts several key features to enhance laundry drying:

Effortless height adjustment: achieve the perfect drying height with a stepless adjustment mechanism, ensuring convenience and ease of use.

Ample space for large laundry: benefit from an extra-large edge length that accommodates even the bulkiest items.

Innovative arm design: innovative design provides stability and efficiency during use.

360-degree rotation: enjoy the flexibility of a freely rotatable design, providing the ability to maximize sun exposure for faster and more even drying.

The ideal choice for a dependable rotary clothes dryer that can handle large laundry loads. Designed with a focus on functionality and durability, this dryer is a trusted household asset. Experience impressive stability and long lasting performance without unnecessary frills.

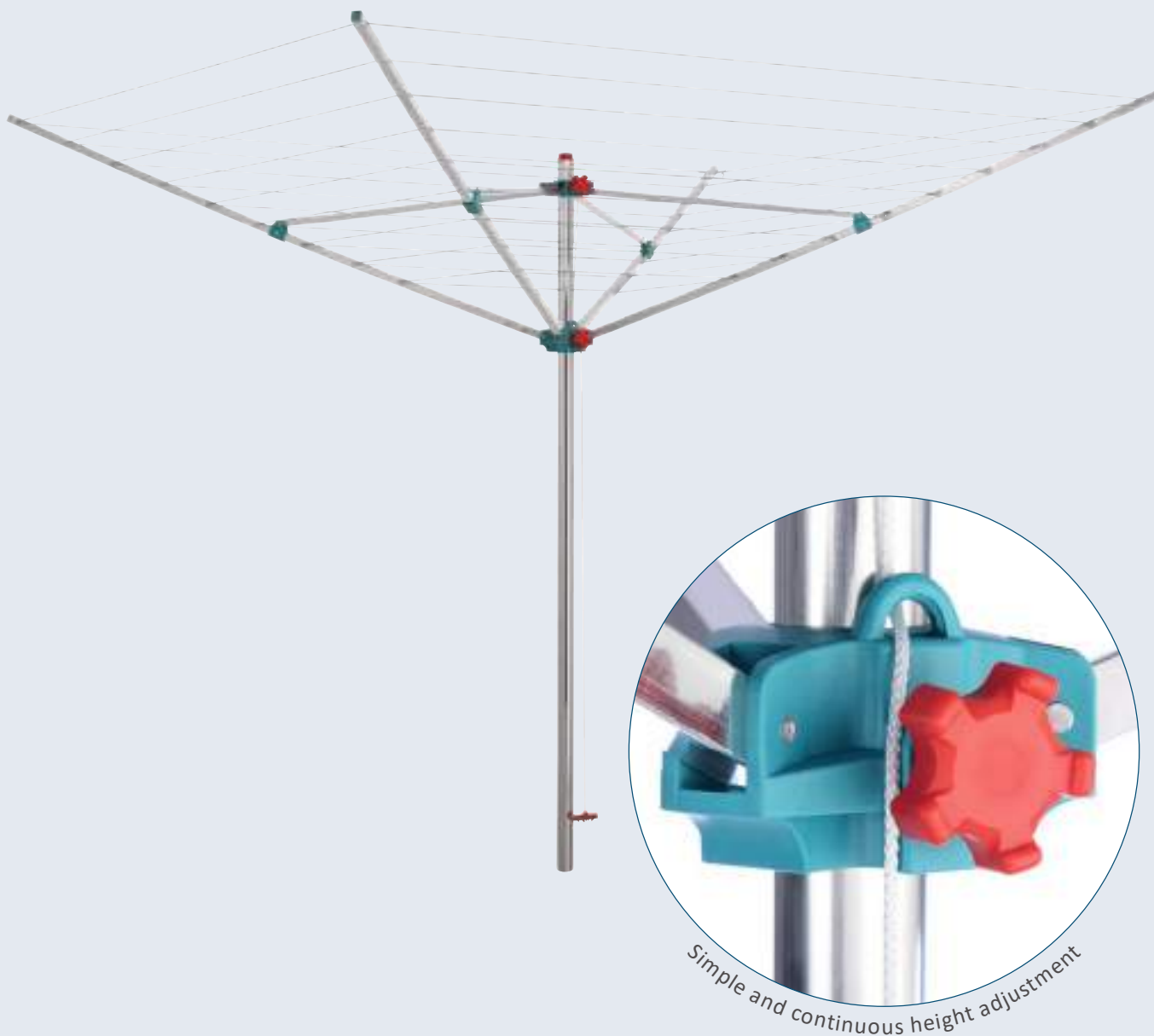

Everything that a rotary dryer needs:

- ✓ Large span e.g. for bedding

- ✓ Sturdy aluminium entry model

- ✓ Seamless height adjustment

- ✓ Weather- and UV-resistant clothesline

- ✓ Freely rotatable

- ✓ Including ground socket with lid

Models

Alustar 50 (4 arm)

- ✓ Line length approx. 50m
- ✓ Edge length: approx. 215cm

Alustar XL (3 arm)

- ✓ Line length approx. 40m
- ✓ Edge length: approx. 215cm

Product No	Size	Pack
82250	4 Arm 50m	10
82256	3 Arm 40m	10

Storage Box 7L

- Dimensions: 250mm x 360mm x 130mm
- 7L storage capacity
- The lid features a unique hinge function, which allows it to open by 100° to facilitate easy access



Product No	Size	Pack
1157602	7L	6

Storage Box 15L

- Dimensions: 250mm x 360mm x 260mm
- 15L storage capacity
- The lid features a unique hinge function, which allows it to open by 100° to facilitate easy access



Product No	Size	Pack
1157502	15L	6

Storage Box 35L

- Dimensions: 370mm x 510mm x 260mm
- 35L storage capacity
- The lid features a unique hinge function, which allows it to open by 100° to facilitate easy access



Product No	Size	Pack
1157402	35L	6

Storage Box 60L

- Dimensions: 370mm x 510mm x 450mm
- 60L storage capacity
- Fitted with adjustable castors for easy storage
- The lid features a unique hinge function, which allows it to open by 100° to facilitate easy access



Product No	Size	Pack
1157302	60L	4

Organiser For Storage Box

- Enhances the functionality of Tatay Storage Boxes by providing designated compartments, making it a versatile addition for keeping items systematically arranged
- Two options to fit all sizes of Tatay Storage Boxes



Product No	Colour	Size	Pack
1157701	White	7L-15L	6
1157801	White	35L-60L	6

Underbed Storage Box 63L

- Dimensions: 450mm x 780mm x 180mm
- 63L storage capacity
- Ideal for maximizing storage space under a bed



Product No	Size	Pack
1158602	63L	6

Baobab Storage Basket 1.5L

- Dimensions: 125mm x 165mm x 100mm
- 1.5L storage capacity
- Sturdy construction and sure grip handles
- With trendy rib effect pattern sides
- Stackable
- Made of polypropylene plastic, free from BpA



Product No	Colour	Size	Pack
7010101	White	1.5L	6
7010114	Anthracite	1.5L	6
7010100	Blue Mist	1.5L	6
7010103	Taupe	1.5L	6

Baobab Storage Basket 5L

- Dimensions: 181mm x 272mm x 130mm
- 5L storage capacity
- Sturdy construction and sure grip handles
- With trendy rib effect pattern sides
- Stackable
- Made of polypropylene plastic, free from BpA



Product No	Colour	Size	Pack
7010201	White	5L	6
7010214	Anthracite	5L	6
7010200	Blue Mist	5L	6
7010203	Taupe	5L	6

Baobab Storage Basket 15L

- Dimensions: 294mm x 385mm x 160mm
- 15L storage capacity
- Sturdy construction and sure grip handles
- With trendy rib effect pattern sides
- Stackable
- Made of polypropylene plastic, free from BpA



Product No	Colour	Size	Pack
7010301	White	15L	6
7010314	Anthracite	15L	6
7010300	Blue Mist	15L	6
7010303	Taupe	15L	6

Baobab Storage Basket 22L

- Dimensions: 294mm x 385mm x 230mm
- 22L storage capacity
- Sturdy construction and sure grip handles
- With trendy rib effect pattern sides
- Stackable
- Made of polypropylene plastic, free from BpA



Product No	Colour	Size	Pack
7010401	White	22L	6
7010414	Anthracite	22L	6
7010400	Blue Mist	22L	6
7010403	Taupe	22L	6

Baobab Storage Basket Sets

- Two set sizes available
- Sturdy construction and sure grip handles
- With trendy rib effect pattern sides
- Stackable
- Made of polypropylene plastic, free from BpA



Product No	Type	Colour	Size	Pack
7010801	Set Of 3	White	5L+ 2x1.5L+ Lid	4
7010814	Set Of 3	Anthracite	5L+ 2x1.5L+ Lid	4
7010900	Set Of 3	Blue Mist	5L+ 2x1.5L	2
7010903	Set Of 3	Taupe	5L+ 2x1.5L	2
7011101	Set Of 4	White	15L+5L+2x1.5L	4
7011114	Set Of 4	Anthracite	15L+5L+2x1.5L	4

Baobab Storage Basket Lid

- Lids for Baobab Storage Baskets
- Made of polypropylene plastic, free from BpA

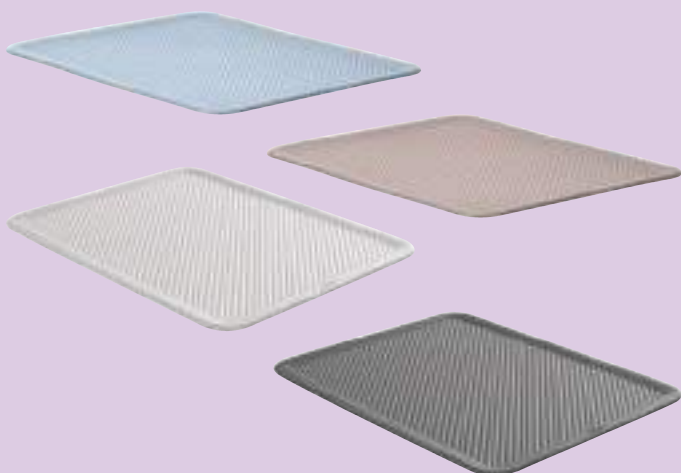

Product No	Colour	Size	Pack
7011201	White	Fits 5L	4
7011214	Anthracite	Fits 5L	4
7011200	Blue Mist	Fits 5L	4
7011203	Taupe	Fits 5L	4
7011401	White	Fits 15L & 22L	4
7011414	Anthracite	Fits 15L & 22L	4
7011400	Blue Mist	Fits 15L & 22L	4
7011403	Taupe	Fits 15L & 22L	4

Baobab Organiser Slim

- Dimensions: 90mm x 240mm x 56mm
- Sturdy construction
- With trendy rib effect pattern sides
- Can be used on a surface or within a drawer
- Made of polypropylene plastic, free from BpA



Product No	Colour	Pack
7012001	White	6
7012000	Anthracite	6

Baobab Organiser A6

- Dimensions: 113mm x 170mm x 56mm
- A6 storage capacity
- Sturdy construction
- With trendy rib effect pattern sides
- Stackable
- Made of polypropylene plastic, free from BpA



Product No	Colour	Size	Pack
7012101	White	A6	6
7012100	Anthracite	A6	6

Baobab Organiser A5

- Dimensions: 177mm x 240mm x 56mm
- A5 storage capacity
- Sturdy construction
- With trendy rib effect pattern sides
- Stackable
- Made of polypropylene plastic, free from BpA



Product No	Colour	Size	Pack
7012201	White	A5	6
7012200	Anthracite	A5	6

Baobab Organiser A4

- Dimensions: 247mm x 336mm x 56mm
- A4 storage capacity
- Sturdy construction
- With trendy rib effect pattern sides
- Stackable
- Made of polypropylene plastic, free from BpA



Product No	Colour	Size	Pack
7012301	White	A4	6
7012300	Anthracite	A4	6

Baobab Organisers Set Of 4

- Set contains 1 each of Slim, A6, A5 and A4 sizes
- Sturdy construction
- With trendy rib effect pattern sides
- Stackable
- Made of polypropylene plastic, free from BpA



Product No	Colour	Size	Pack
7012501	White	Various	6
7012500	Anthracite	Various	6

Baobab Toilet Brush

- Sturdy construction with trendy rib effect pattern sides
- Made of polypropylene plastic, free from BpA
- Adds a touch of sophistication to the bathroom decor



Product No	Colour	Pack
6390301	White	4
6390314	Anthracite	4
6390300	Blue Mist	4
6390303	Taupe	4

Baobab Laundry Hamper

- Generous capacity to accommodate large loads of laundry
- With trendy rib effect pattern sides
- The hinged lid ensures a tidy appearance, conceals the contents and minimises odours



Product No	Colour	Size	Pack
1010001	White	40L	4
1010014	Anthracite	40L	4
1010000	Blue Mist	40L	4
1010003	Taupe	40L	4

Baobab Laundry Basket

- Generous capacity to accommodate large loads of laundry
- With trendy rib effect pattern sides
- Strong and sturdy construction ensure longevity



Product No	Colour	Size	Pack
1042001	White	35L	4
1042014	Anthracite	35L	4
1042000	Blue Mist	35L	4
1042003	Taupe	35L	4

Laundry Basket

- Designed for convenience, featuring a sturdy handle and a curved shape which comfortably sits on the hip, offering an ergonomic user experience
- Durable construction ensures long-lasting use
- 8kg weight capacity



Product No	Colour	Size	Pack
1100501	White	30L	6

Smart Pedal Bin

- Tall and sleek design with a 25L capacity
- The convenient foot pedal ensures hands-free operation, promoting hygiene and ease of use
- The integrated bag tidy rim cover keeps bags neatly hidden



Product No	Colour	Size	Pack
1021027	Black	25L	4
1021201	Deco Marble	25L	4
1021202	Deco Wood	25L	4

Milan Bathroom Pedal Bin

- With a sleek finish, this bin complements contemporary interiors, adding a touch of elegance to the space
- Designed for convenience, the flip lid mechanism ensures easy and hygienic disposal of waste



Product No	Colour	Size	Pack
4470201	White	3L	6
4470214	Grey	3L	6
4470215	Taupe	3L	6

Mop Bucket With Wheels

- Wheeled base ensures effortless manoeuvrability
- Featuring a fill line indicator, spout and handle



You may also need...
SEE PAGE 272

Product No	Colour	Size	Pack
1103206	Grey	13L	6

View the Tatay storage range on page 284



Cold Cuts Container

- Flat design for unique fridge storage of meats and cheeses
- Suitable for microwave cooking up to 100°C
- Suitable for use in the freezer down to -40°C
- Stackable for easy storage
- Food safe
- BPA free
- Dishwasher safe

Cold Cuts Container Mini

- Flat design for unique fridge storage of meats and cheeses
- Suitable for microwave cooking up to 100°C
- Suitable for use in the freezer down to -40°C
- Stackable for easy storage
- Food safe
- BPA free
- Dishwasher safe

Cold Cuts Container Maxi

- Ideal for fridge storage of larger meats, cheeses, fruit and vegetables
- Suitable for microwave cooking up to 100°C
- Suitable for use in the freezer down to -40°C
- Stackable for easy storage
- Food safe
- BPA free
- Dishwasher safe



Product No	Size	Pack
1180001	Single	12
1180901	4 Pack	12

Product No	Pack
1180501	12

Product No	Pack
1180601	6

Cold Cuts Container Cheese

- Ideal for fridge storage of larger meats, cheeses, fruit and vegetables
- Suitable for microwave cooking up to 100°C
- Suitable for use in the freezer down to -40°C
- Stackable for easy storage
- Food safe
- BPA free
- Dishwasher safe

Baguette & Wrap Container

- Great for transporting lunch on the go
- Easy to carry and clean
- Suitable for use in the freezer down to -40°C
- Food safe
- BPA free
- Dishwasher safe

Sandwich Container

- Great for transporting lunch on the go
- Easy to carry and clean
- Suitable for use in the freezer down to -40°C
- Food safe
- BPA free
- Dishwasher safe



Product No	Pack
1180701	12

Product No	Pack
1167004	12

Product No	Pack
1167104	12

Food Containers Twist Set Of 3

- Twist top for secure no leak storage
- Suitable for microwave cooking up to 100°C
- Suitable for use in the freezer down to -40°C
- Stackable for easy storage
- Hermetically sealed
- Food safe
- BPA free
- Dishwasher safe



Product No	Pack
1169400	6

Cook & Eat Hermetic Glass Container

- Oven proof heat resistance up to 450°C
- Suitable for microwave cooking up to 100°C
- Suitable for use in the freezer down to -40°C
- Stackable for easy storage
- Valve on the lid prevents pressure buildup and splashing
- Hermetically sealed
- Food safe
- BPA free
- Dishwasher safe



Product No	Size	Pack
1161509	370ml	6
1161609	640ml	6
1161709	1.1L	6
1161809	1.5L	6

Cook & Eat Hermetic Glass Container Set Of 3

- Oven proof heat resistance up to 450°C
- Suitable for microwave cooking up to 100°C
- Suitable for use in the freezer down to -40°C
- Stackable for easy storage
- Valve on the lid prevents pressure buildup and splashing
- Hermetically sealed
- Food safe
- BPA free
- Dishwasher safe



Product No	Size	Pack
1182509	Various	2

Urban Food & Drink Thermal Bag

- Easy clean
- 100% polyester material
- With thermal liner
- Carrying handle and shoulder strap
- Shower proof
- Contains:
 - 2x 500ml hermetic push fit food containers
 - 1x 400ml drinks bottle



Product No	Colour	Pack
1185500	Black	3
1185506	Casual Stars	3
1185514	Blue	3

Urban Drink Bottle

- Triton material
- Hermetically sealed twist top lid with thread for no leaks
- Lid can be used as a drinks cup
- With handy carrying handle
- Food safe and shatter proof
- BPA free
- Dishwasher safe



Product No	Colour	Size	Pack
1189014	Grey	400ml	10
1189016	Red	400ml	10
1189001	Blue	400ml	10
1189114	Grey	650ml	10
1189116	Red	650ml	10
1189101	Blue	650ml	10

Foil Tray With Lid



Product No	Size	Pack
1001A	450cc/16oz 10 Pack	48
1002	656cc/23oz 6 Pack	40
1004	850cc/30oz 4 Pack	30
1008	1620cc/60oz 5 Pack	16

Foil Tray



Product No	Size	Pack
1013	1780cc/60oz 2 Pack	48
1014	3740cc/132oz 2 Pack	36

Foil Roasting Tray



Product No	Size	Pack
1016	2 Pack	18

Foil Baking Tray



Product No	Size	Pack
1027	3 Pack	24

Foil Pie Plate



Product No	Size	Pack
1021	197mm/8 inch 8 Pack	48
1023	227mm/9 inch 6 Pack	40

Foil Family Pie Plate



Product No	Size	Pack
1025	250mm/10 inch 3 Pack	25

Foil Pie Dish



Product No	Size	Pack
1032	110cc/4oz 18 Pack	40
1034	480cc/16oz 6 Pack	45

Foil Pudding Basin



Product No	Size	Pack
1044	1lb 4 Pack	32
1046	2lb 2 Pack	24

Foil Mini Pudding Basin



Product No	Size	Pack
1041	170cc/6oz 10 Pack	48

Foil Flan Case



Product No	Size	Pack
1052	164mm/6 inch 9 Pack	36
1054	215mm/8 inch 6 Pack	30

Foil Platter



Product No	Size	Pack
1070	350mm/14 inch 2 Pack	12
1072	430mm/17 inch 3 Pack	12
1073	558mm/22 inch 2 Pack	12

Plastic Tray With Lid



Product No	Size	Pack
2001	500ml 6 Pack	16
2002	650ml 5 Pack	16
2005	1000ml 4 Pack	16

Cupcake Cases



Product No	Size	Pack
1704	White 100 Pack	12
1702	Pink Spot 100 Pack	12

Petit Four Cases



Product No	Size	Pack
1701	100 Pack	16

Muffin Cases



Product No	Size	Pack
1706	50 Pack	36

Cake Tin Liner



Product No	Size	Pack
1717	8 inch 50 pack	24

Loaf Tin Liner



Product No	Size	Pack
1716	1lb 40 Pack	24
1715	2lb 40 Pack	24



Cake Board



Product No	Size	Pack
2150	3mm Round 20cm/8 inch	10
2151	3mm Round 25cm/10 inch	10
2152	3mm Round 30cm/12 inch	10
2153	3mm Round 35cm/14 inch	10
2160	3mm Square 20cm/8 inch	10
2161	3mm Square 25cm/10 inch	10
2162	3mm Square 30cm/12 inch	10
2163	3mm Square 35cm/14 inch	10

Cake Drum



Product No	Size	Pack
2155	12mm Round 20cm/8 inch	5
2156	12mm Round 25cm/10 inch	5
2157	12mm Round 30cm/12 inch	5
2158	12mm Round 35cm/14 inch	5
2166	12mm Square 25cm/10 inch	5
21671	12mm Square 30cm/12 inch	5
2168	12mm Square 35cm/14 inch	5

Doyleys



Product No	Size	Pack
1721	24 Pack	10

Lolly Sticks



Product No	Size	Pack
1146	6 inch 24 Pack	10

Ice Cube Bags



Product No	Size	Pack
1650	10 Pack	24

Freezer Bags



Product No	Size	Pack
1120	18cm x 23cm 40 Pack	10
1121	23cm x 33cm 20 Pack	10
1122	28cm x 35cm 18 Pack	10
1123	30cm x 45cm 12 Pack	10

Cocktail Sticks



Product No	Size	Pack
N1141	150 Pack	48

Paper Straws



Product No	Type	Pack
1646	Multicoloured Stripe 25 Pack	24
1652	Blue & Pink Star 25 Pack	24
1653	Gold Stripe 20 Pack	24
1654	Silver Stripe 20 Pack	24

Assorted Wooden Cutlery



Product No	Size	Pack
1524	24 Pack	40

Paper Plate



Product No	Size	Pack
1401	18cm/7 inch 20 Pack	10
1402	23cm/9 inch 20 Pack	10

Paper Bowl



Product No	Size	Pack
1428	10 Pack	24



Plastic Cup



Product No	Size	Pack
1601	18cl 20 Pack	12
1603	18cl 50 Pack	24
1605	18cl 100 Pack	30

Shot Glass



Product No	Size	Pack
1619	40 Pack	24

Wine Glass



Product No	Size	Pack
N5006	6 Pack	12

Spirit Glass



Product No	Size	Pack
1621	12 Pack	24

Half Pint Tumbler



Product No	Size	Pack
1622	350ml 18 Pack	24

Pint Tumbler



Product No	Size	Pack
1623	500ml 12 Pack	20

Napkins

- 2 ply
- 20 napkins per pack



Product No	Colour	Pack
1266	Red	15
1267	Green	15
1268	Pink	15
1269	Dark Blue	15
1270	Light Blue	15
1272	Ivory	15
1273	White	15
2014	Gold	15
2015	Silver	15

Disposable Table Cover

- 90cm/35" square table cover
- Quality disposable paper
- 2 pack



Product No	Colour	Pack
1320	White	10
1321	Red	10
1322	Pink	10
1324	Light Blue	10
1325	Dark Blue	10
1327	Dark Green	10
1332	Ivory	10
1333	Dark Yellow	10
1334	Purple	10
2047	Gold	10
2048	Silver	10

Reusable Toastabags

- The perfect way to make toasted sandwiches
- Available in 3 varieties: 50, 100 and 300 uses each
- 2 Toastabags per pack



Product No	Type	Pack
TBO2W-CS	300 Use	12
TBG2W-CS	100 Use	12
TB502PP-CS	50 Use	12

Panini Grill Bags

- Keeps griddles and grills clean
- Non-stick and reusable
- Bag dimensions 320mm x 166mm
- 2 bags per pack
- Use each bag up to 50 times



Product No	Pack
PGB2PP-CS	12

Microwave Steam Bags

- Healthy and easy way to cook veg, chicken and fish
- Retains flavour and goodness in food
- Available in 3 sizes
- Standard: contains 25 bags
- Medium: contains 30 bags
- Large: contains 25 bags



Product No	Size	Pack
QSS25PP-CS	Standard	12
QSM30PP-CS	Medium	12
QSL25PP-CS	Large	12

Roasting Bags

- Retains nutrients
- Keeps ovens clean
- Browns meat without basting
- Available in 3 sizes
- Standard: contains 8 bags
- Large: contains 2 bags
- Jumbo: contains 2 bags



Product No	Size	Pack
RBS8PP-CS	Standard	12
RBL2PP-CS	Large	12
RBJ2PP-CS	Jumbo	12

Oven & BBQ Bags

- Seals in sauces and marinades
- For ovens, BBQs, griddles and hotplates
- Keeps cooking surfaces clean
- Available in 2 sizes
- Standard: contains 6 bags
- Large: contains 10 bags



Product No	Size	Pack
BBQS8PP-CS	Standard	12
BBQL10PP-CS	Large	12

Cookafish Oven Bags

- Self-basting oven bags
- Retains nutrients
- Helps keep fishy smells under control
- Each pack contains 10 bags



Product No	Pack
CF10PP-CS	12

Soup & Sauce Bags

- Liquid storage bags for the fridge and freezer
- Stand up with press seal
- Use for soups, sauces, smoothies and blends
- Space saving – takes up less room than tubs and pots
- Reusable
- 6 bags per pack



Product No	Size	Pack
SSBS6CW-CS	1L	12

Microwave Mat

- Non-slip silicone mat
- Prevents bowls and dishes from slipping and sliding
- Keeps microwave plate clean
- Easy clean
- 25cm diameter



Product No	Pack
MMB25PP-CS	12

Microwave Bacon Sheets

- Crispy bacon made easy in the microwave
- Perfectly cooked bacon in minutes
- Quick and easy
- No washing up
- Absorbs fat to aid a healthier diet
- Quicker than grilling and healthier than frying



Product No	Size	Pack
BS5PP-CS	5 Pack	12
BS10PP-CS	10 Pack	12

Fat Controller Pads

- Drains and absorbs fats for healthier cooking
- Reflective coating gives even browning
- Use up to 190°C



Product No	Size	Pack
FC3PP-CS	3 Pack	12
FC10PP-CS	10 Pack	12

Frying Pan Liner

- Reusable and non-stick
- Keeps pans clean
- Available in 2 sizes
- Can be cut to size



Product No	Size	Pack
FPL24PP	24cm	12
FPL26PP	26cm	12

Slow Cooker Liners

- Holds up to 6.5L
- Keeps slow cookers clean
- Seals in flavour in the food
- Each pack contains 5 bags
- Bag dimensions: 30cm x 55cm



Product No	Pack
SCL5PP-CS	12

Air Fryer Liner

- Non-stick and reusable
- Easy to clean
- Dishwasher safe
- Food safe – BPA and PFOA free
- Temperatures up to 260°C
- Holes in liner allow air to circulate for perfect air fryer cooking



Product No	Size	Pack
AFLN5L1W	2L-5L 1 Pack	24
AFLN5L2W	2L-5L 2 Pack	24
AFLN7L2W	5L-7L 2 Pack	24



Premium Air Fryer Liner

- Helps keep air fryers clean
- Premium quality – thicker, heavier and lasts longer
- Fits most circular and square air fryers up to 5L size
- Non-stick and easy to clean
- Holes allow air to circulate
- Prevents cooked on food, saving cleaning time



Product No	Size	Pack
AFLPN5L1W	2-5L 2 Pack	12

Cooking Liner

- Reusable and non-stick
- Keeps oven trays and pans clean
- Available in 2 sizes
- Can be cut to size



Product No	Size	Pack
CSG3336PP-CS	33cm x 36cm	12
CSG3340PP-CS	33cm x 40cm	12

Easiliner

- Keeps pans, trays and dishes clean
- Saves hours of soaking and scrubbing
- Non-stick
- 18no. 45cm x 50cm sheets
- Can be cut to size
- Can be used in the oven, microwave, fridge and freezer

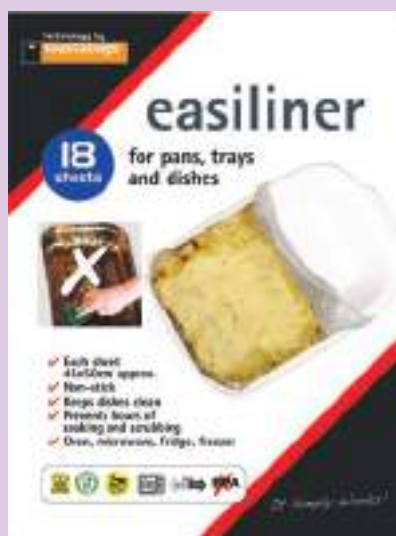

Product No	Size	Pack
EAS18PK-CS	45cm x 50cm	12

Heavy Duty Oven Liner

- Keeps base of the oven clean
- Non-stick
- Easy to clean
- Suitable for all oven types
- Can be cut to size



Product No	Size	Pack
HDOL4050HB	40cm x 50cm	6

Extendable Oven Shelf

- 2 varieties - liner shelf and mesh shelf
- Use as an extra shelf to cook directly on
- Oven liner shelf can be used to catch drips and spills when the heating element is in the base of the oven and traditional oven liner cannot be used



Product No	Type	Pack
OSLCW	Liner	20
OSMCW	Mesh	20

Protecta Oven Shelfguard

- Slot on to front of oven shelves to protect hands and arms from burns
- Easy to fit
- Withstands temperatures up to 260°C
- 2 pack



Product No	Pack
SGP2	24

Gas Hob Protectors

- Pack of 4
- 27cm x 27cm size
- Protect gas hobs from burnt on spills
- Non-stick
- Wipe clean
- Available in black or silver



Product No	Colour	Pack
GHPB4PP-CS	Black	12
GHPS4PP-CS	Silver	12

BBQ Grill Mat

- Heavy duty
- Perfect for use directly on the grill
- Reusable and non-stick
- Keeps BBQ clean while retaining the BBQ flavour
- Prevents food falling through grill



Product No	Size	Pack
BQGMHT	40cm x 45cm	18

BBQ Hotplate Liner

- Reusable and non-stick
- Keeps hot plates clean



Product No	Size	Pack
BQHPL4050HT	40cm x 50cm	24

Crispease

- Reusable
- Non-stick
- Easy clean
- Silicone trim
- Allows air to circulate, resulting in crispy food
- Great alternative to the solid baking tray
- Available in 3 types



Product No	Type	Pack
CEOT	Oven Tray	12
CEBG	Baguette Tray	12
CEPC	Pizza Tray	12

Pizzamesh

- Non-stick
- Reusable
- Easy clean
- Mesh allows air to circulate for crispy pizza
- Gives stability to pizza when lifting in and out of the oven
- Available in 2 colours



Product No	Colour	Size	Pack
BRPM320-CS	Natural	32cm	12
BLPM320-CS	Black	32cm	12

Quickachips Tray

- Reusable
- Non-stick
- Easy clean
- Allows air to circulate, resulting in crispy oven chips
- Available in natural or black colours and various sizes



Product No	Colour	Size	Pack
BRMB300-CS	Natural	30cm	12
BRMB330-CS	Natural	33cm	12
BLMB330-CS	Black	33cm	12
BLMB360-CS	Black	36cm	12

Cookamesh

- Reusable non-stick mesh for baking, grilling and cooking
- Place on oven tray or directly on oven shelf
- Easy clean
- Available in black or natural in 3 sizes



Product No	Colour	Size	Pack
BRM2131-CS	Natural	21cm x 31cm	12
BRM2437-CS	Natural	24cm x 37cm	12
BRM3340-CS	Natural	33cm x 40cm	12
BLM2131-CS	Black	21cm x 31cm	12
BLM2437-CS	Black	24cm x 37cm	12
BLM3340-CS	Black	33cm x 40cm	12

Make & Bake Universal Cake Tin Liner

- Twin pack
- Non-stick
- Reusable
- Easy lift out liners



Product No	Pack
CTLU2HB	6

Make & Bake Cake Tin Liner

- Circle base and side wall
- A great alternative to parchment paper
- Reusable
- Non-stick - no need to grease
- Available in 3 popular sizes in single or twin packs



Product No	Size	Pack
MBCT7PT-CS	7 inch	12
MBCT8PT-CS	8 inch	12
MBCT9PT-CS	9 inch	12
MBCT72PT-CS	7 inch 2 Pack	12
MBCT82PT-CS	8 inch 2 Pack	12
MBCT92PT-CS	9 inch 2 Pack	12

Make & Bake Universal Loaf Tin Liner

- Easy lift out liners
- Non-stick - no need to grease
- Reusable
- Fits 1lb and 2lb tins
- Single pack



Product No	Pack
LTLUPP-CS	12

Make & Bake Baking Liner

- Non-stick
- A great reusable alternative to parchment paper



Product No	Size	Pack
BLFG3340PP-CS	33cm x 40cm	12

Make & Bake Heavy Duty Baking Liner

- Non-stick
- Heavy duty
- A great reusable alternative to parchment paper
- Available in 2 popular sizes



Product No	Size	Pack
BLHD3340PVC	33cm x 40cm	18
BLHD33100PVC	33cm x 100cm	18

Make & Bake Silicone Baking Mat

- For rolling, piping and baking
- Reinforced silicone
- Non-stick
- Heavy duty

Product No	Size	Pack
BM3040PPW	30cm x 40cm	25

Make & Bake Silicone Piping Set

- Reusable silicone piping bag with 5 different nozzles
- Great for cakes and mashed potato alike



Product No	Pack
SPSLCB	6

Eco Food & Freezer Bags

- Biodegradable and compostable
- Tie handle
- For storing and freezing food
- 30 bags per pack



Product No	Pack
EFFBM30CW-CS	12

Eco Sandwich Bags

- Biodegradable and compostable
- Tie handle
- Perfect for sandwiches and snacks
- 25 bags per pack



Product No	Pack
ESWB25CW-CS	12

Eco Compostable Food Wrap

- An eco-friendly alternative to cling film
- 100% compostable



Product No	Size	Pack
EFW20CB	30cm x 20m	20

Eco Paper Sandwich & Snack Bags

- 100% unbleached greaseproof paper
- Ideal for sandwiches and snacks
- 25 bags per pack



Product No	Pack
EPSWB25CB	20

Eco Microwave Steam Bags

- Biodegradable and compostable
- Steam cook vegetables, chicken and fish in the microwave in minutes
- 15 bags per pack



Product No	Pack
EQSM15CW-CS	12

Freezer Liner

- Prevents build-up of ice and frost on the freezer
- 25cm x 50cm approx.
- Available in single or twin pack



Product No	Type	Pack
FL25501PP-CS	Single	12
FL25502PP-CS	Twin	12

Fridge Liner

- Perforated liner absorbs excess moisture from salad and vegetables, keeping them fresher for longer
- Place in salad tray or directly on the shelf
- Cut to size if required
- Keeps shelves and trays clean



Product No	Type	Pack
FTL2PP-CS	2 Pack	12
FTL4PP-CS	4 Pack	12

Bubble Silicone Fridge & Freezer Bag

- Easy fill pourable silicone storage pouch
- Self-standing
- With airtight seal
- For use in the fridge, freezer and microwave



Product No	Pack
BUB/FFCB	12

Bubble Silicone Stretch Lids

- Easy fit
- Airtight seal
- Easy open
- Leak proof
- Perfect for bowls, dishes, plates, cans, jars, mugs etc
- Stretch to fit most shapes

Product No	Pack
BUB/SL6CB	12



Planit Display

- This display of best-selling items contains:
 - 24no. Reusable Toastabags 50 Use 2 Pack
 - 24no. Cooking Liner 33cm x 36cm
 - 24no. Microwave Steam Bags Standard 25 Pack
 - 24no. Slow Cooker Liners 5 Pack
 - 24no. Roasting Bags Standard 8 Pack
 - 24no. Roasting Bags Large 2 Pack

Product No	Pack
FDUUK2	1





Glass Worktop Saver



1



2



3



4



6



7



8



9



10



11



12



13



14



15



16



17



18



19



20



21



22



23



24



25



26



27



28



29



30



31



32



33



34



35



36

- The ultimate kitchen board
- Hygienic, versatile and odour and stain resistant
- Made from toughened glass, able to withstand temperatures up to 250° C
- Made to British Standards with components of the highest quality
- With non-slip rubber feet
- Ideal for all types of food preparation
- Supplied in attractive retail packaging

Product No	Design	Size	Pack	
1	BARNL	Barny Owl	40cm x 50cm	1
1	BARNS	Barny Owl	30cm x 40cm	1
2	BLACL	Black	40cm x 50cm	1
2	BLACS	Black	30cm x 40cm	1
3	BLUTL	Blue Tit	40cm x 50cm	1
3	BLUTS	Blue Tit	30cm x 40cm	1
4	BRITL	British Birds	40cm x 50cm	1
4	BRITS	British Birds	30cm x 40cm	1
	CLEAL	Clear	40cm x 50cm	1
	CLEAS	Clear	30cm x 40cm	1
6	COLLS	Collies	30cm x 40cm	1
7	COUKL	Country Kitchen	40cm x 50cm	1
7	COUKS	Country Kitchen	30cm x 40cm	1
8	DAFFL	Daffodil	40cm x 50cm	1
8	DAFFS	Daffodil	30cm x 40cm	1
9	DEHL	Old English Herbs	40cm x 50cm	1
9	DEHS	Old English Herbs	30cm x 40cm	1
10	DDVL	Deg De Vin	40cm x 50cm	1
10	DDVS	Deg De Vin	30cm x 40cm	1
11	DOWNL	Down On The Farm	40cm x 50cm	1
11	DOWNS	Down On The Farm	30cm x 40cm	1
12	ENCL	Enjoy Cheese	40cm x 50cm	1
12	ENCS	Enjoy Cheese	30cm x 40cm	1
13	FMHL	Farmhouse	40cm x 50cm	1
14	INSS	Inspiration	30cm x 40cm	1
15	MAPAS	Mallard Passing	30cm x 40cm	1
16	MARBL	Marble	40cm x 50cm	1
16	MARBS	Marble	30cm x 40cm	1
17	PHESL	Pheasants	40cm x 50cm	1
17	PHESS	Pheasants	30cm x 40cm	1
18	POPPL	Poppies	40cm x 50cm	1
18	POPPS	Poppies	30cm x 40cm	1
19	SCOTL	Swan Cottage	40cm x 50cm	1
19	SCOTS	Swan Cottage	30cm x 40cm	1
20	SHEEL	Sheep Dog	40cm x 50cm	1
20	SHEES	Sheep Dog	30cm x 40cm	1
21	STSS	Stones	30cm x 40cm	1
22	SUSSL	Sussex Pair	40cm x 50cm	1
22	SUSSS	Sussex Pair	30cm x 40cm	1
23	THRES	Three Of A Kind	30cm x 40cm	1
24	WHITL	White	40cm x 50cm	1
24	WHITS	White	30cm x 40cm	1
25	SG3040PRIDE	Pride & Joy	30cm x 40cm	1
26	NT3141001	NT Butterflies	30cm x 40cm	1
27	NT3141009	NT Bees	30cm x 40cm	1
28	NT3141003	NT Hare	30cm x 40cm	1
29	NT3141008	NT Oystercatcher	30cm x 40cm	1
30	SG3141BEEAL	Bees & Lavender	30cm x 40cm	1
31	SG3100SB	Songbird	30cm x 40cm	1
32	SG31003PO	Pecking Order	30cm x 40cm	1
33	SG3040GARH	Gardeners Helper	30cm x 40cm	1
34	SG3141OLIVE	Olivewood	30cm x 40cm	1
35	SG3141WEI	Measures Chalk	30cm x 40cm	1
36	SG3141SELDOG	Dogs Selfie	30cm x 40cm	1



Display stand available
- contact us for details

DESIGNED FOR COOKING.

Brabantia cookware collections 2024



 brabantia



DESIGNED FOR COOKING.

Can practical be beautiful? We think so. In fact our products are so delightful; they transform daily chores into a domestic pleasure. And because they're stylish and well made, you will love using them for as long as you want – without feeling guilty when you finally let them go.

ENJOY FOOD.

As we spend more and more time in the kitchen the things we use become increasingly important to us. When cooking, mixing and preparing food looks this good, it becomes even more of a pleasure.



MISSION.

We and our partners create success through delighted and returning customers with beautiful, sustainable and functional solutions for living, giving and cooking.

Allinox is our exclusive cookware partner for manufacturing, distributing and promoting Brabantia Cookware worldwide since 2001.









INDU+

- Aluminium body, ensuring a quick and even heat distribution.
- Stay-cool bakelite handles.
- Timeless light grey colourway in matt finish.
- Excellent non-stick properties; ceramic coating for an extra strong and durable non-stick frying surface. Free from PTFE, lead or cadmium.
- Easy to clean.
- Glass lid with air vent hole to prevent boiling over and allowing steam to escape.
- Suitable for all heat sources, incl. induction.
- Not oven suitable.

3-year guarantee



	Ø	Product No	Description	Vol.(L) / Cap	Pack	Barcode
	16 cm	30005014	SAUCEPAN NON-STICK Colour sleeve	1,4	6	5410577132953
	20 cm	30004850	FRYING PAN NON-STICK Colour sleeve	2  3  4  5 	6	5410577132281
	24 cm	30004851	Colour sleeve		6	5410577132298
	28 cm	30004852	Colour sleeve		6	5410577132304
	30 cm	30004853	Colour sleeve		6	5410577132311
	28 cm	30004856	SKILLET NON-STICK Colour sleeve	4,0	6	5410577132342
	28 cm	30004855	WOK NON-STICK Colour sleeve		6	5410577132335
	24 cm	30004854	PANCAKE PAN NON-STICK Colour sleeve		6	5410577132328
	26 cm	30005184	GRILL PAN NON-STICK Colour sleeve		6	5410577134292

*Ceramic coating
PFAS-free*



INDU+ SET

- Aluminium body, ensuring a quick and even heat distribution.
- Stay-cool bakelite handles.
- Excellent non-stick properties; ceramic coating for an extra strong and durable non-stick frying surface. Free from PTFE, lead or cadmium.
- Easy to clean.
- Glass lid with air vent hole to prevent boiling over and allowing steam to escape.
- Suitable for all heat sources, incl. induction.
- Not oven suitable.

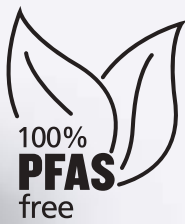

3-year guarantee



Ø	Product No	Description	Vol.(L) / Cap	Pack	Barcode
---	------------	-------------	---------------	------	---------

**COOKING PLEASURE
5-8 PCS SET**



	30005095	Colour box		2	5410577133721
18 cm		saucepan with lid	2,0		
20 cm		casserole with lid	2,5		
24 cm		casserole with lid	4,5		
20 cm		frying pan non-stick	2 		
28 cm		frying pan non-stick	4 		

+ 2 free pan protectors

Ø	Product No	Description	Vol.(L) / Cap	Pack	Barcode
---	------------	-------------	---------------	------	---------

**START TO COOK
4-7 PCS SET**



	30004651	Colour box		2	5410577130737
16 cm		saucepan with lid	1,4		
20 cm		casserole with lid	2,5		
24 cm		casserole with lid	4,5		
24 cm		frying pan non-stick	3 		







BALANCE

- High quality forged aluminium body with full induction base.
- Thick base, better heat distribution, excellent base stability.
- Outside finish: matt black heat resistant paint.
- 3-Layer non-stick coating with extremely high performance, easy to clean.
- Secure riveted handles for sustainable use.
- Glass lid with stainless steel rim and air vent hole to prevent boiling over and allowing steam to escape.
- Easy pouring spout for non-drip pouring (saucepan).
- Suitable for all heat sources, incl. induction.
- Oven suitable up to 200°C.

5-year guarantee



Ø	Product No	Description	Vol.(L) / Cap	Pack	Barcode
	16 cm 30004032	SAUCEPAN NON-STICK Colour box	1,5	4	5410577124743
	16 cm 30004207 18 cm 30004208 20 cm 30004033 24 cm 30004034	CASSEROLE NON-STICK Colour box Colour box Colour box Colour box	1,5 2,1 2,8 4,5	4 4 4 4	5410577126846 5410577126853 5410577124750 5410577124767
	20 cm 30004029 24 cm 30004030 28 cm 30004031	FRYING PAN NON-STICK Colour sleeve Colour sleeve Colour sleeve		2↑ 3↑ 4↑	4 5410577124712 4 5410577124729 4 5410577124736
	30 cm 30004035	SKILLET NON-STICK Colour box	5,0	4	5410577124774



FUTURA RECYCLED

- Certified post-consumer recycled stainless steel to drive the circular economy approach. Less can mean so much more.
- Improved material characteristics compared to its non-recycled predecessor.
- Encapsulated base for optimal heat distribution. Heats up fast and reduces the cooking time.
- Ergonomic stainless steel handles.
- Glass lid with stainless steel rim and air vent hole to prevent boiling over and allowing steam to escape.
- Inner capacity marks: no need for a measuring jug.
- Dishwasher-safe.
- Suitable for all heat sources, incl. induction.
- Oven suitable up to 200°C.

10-year guarantee

NEW

**MADE WITH
+90% RECYCLED
STAINLESS
STEEL**



Ø	Product No	Description	Vol.(L) / Cap	Pack	Barcode
---	------------	-------------	---------------	------	---------

4-7 PCS SET



	100145	Colour box		2	5410577029468
14 cm		saucepan	1,0		
16 cm		casserole with lid	1,5		
18 cm		casserole with lid	2,1		
20 cm		casserole with lid	3,0		

OVER 90% RECYCLED MATERIAL CONTENT IN OUR STAINLESS STEEL BODY.

Sustainable, recyclable, long-lasting and resource-efficient stainless steel because we are working towards a world that lasts forever.

The highest-recycled material content rate in the industry of over 90%. This significantly reduces the need to extract new minerals and ores from the ground and minimises the environmental impact of our production processes.

The recycled stainless steel not only helps save the world's resources, it is also the most durable material for cookware. Stainless steel is known for being very resistant to heavy use, cleaning and can withstand high heat. The fact that we now use recycled stainless steel does not compromise the performances of this highly durable material.





- Elegant design with matt brushed finish.
- Excellent non-stick properties; Titanium reinforced ceramic coating for an extra strong and durable non-stick frying surface. Free from PTFE, lead or cadmium.
- Inner capacity marks: no need for a measuring jug.
- Glass lid with stainless steel rim and air vent hole to prevent boiling over and allowing steam to escape.
- Encapsulated base for optimal heat distribution.
- Suitable for all hobs incl. induction and oven. (*)

10-year guarantee (5 years for coated items)



(*) items with long handle are not suitable for the oven, due to the bakelite material

ENJOYMENT

	Ø	Product No	Description	Vol.(L) / Cap	Pack	Barcode
	16 cm	30004715	SAUCEPAN Colour box	1,6	6	5410577131215
	20 cm	30004716	CASSEROLE Colour box	3,0	6	5410577131222
	24 cm	30004717	STOCKPOT Colour box	7,5	4	5410577131239
	20 cm	30005031	FRYING PAN NON-STICK Colour sleeve	2 	8	5410577133110
	24 cm	30004719	Colour sleeve	3 	8	5410577131253
	28 cm	30005032	Colour sleeve	4 	8	5410577133127
	28 cm	30004720	FRYING PAN Colour sleeve	4 	8	5410577131260
	24 cm	30004718	SKILLET Colour box	3,0	6	5410577131246
			4-7 PCS SET			
	16 cm	30004793	Colour box saucepan with lid	1,4	2	5410577131727
	20 cm		casserole with lid	2,8		
	24 cm		stockpot with lid	4,4		
	24 cm		frying pan non-stick	3 		
	16 cm	30004848	Colour box saucepan	1,6	2	5410577132264
	16 cm		casserole with lid	2,0		
	20 cm		casserole with lid	3,0		
	24 cm		casserole with lid	5,1		



THE DUTCH

- Cast-iron is an excellent heat conductor and retains heat for a long time.
- Ideal for baking bread or simmering stews for hours.
- The extra-thick enamel finish is scratch-resistant, making this dutch oven extremely easy to clean and maintain.
- The small nubs under the lid distribute the cooking juices uniformly and ensure that the preparation is sprinkled naturally with this moisture.
- Suitable for all heat sources, incl. induction. Perfectly suitable for use in the oven and even on the grill.

25-year guarantee

Ø	Product No	Description	Vol.(L) / Cap	Pack	Barcode	
	20 cm	30004690	DUTCH OVEN - AUBERGINE RED Colour box	2,0	2	5410577130966
	24 cm	30004691	DUTCH OVEN - PINE GREEN Colour box	4,0	2	5410577130973
	28 cm	30004692	DUTCH OVEN - BLACK Colour box	4,5	2	5410577130980
	28 cm	30005033	DUTCH OVEN XL - NIGHT BLUE Colour box	6	2	5410577133134
	28cm	30005034	GRILL - NIGHT BLUE Colour box	4 	2	5410577133141

*Firm handle
for good grip*



T-TIME

- Including stainless steel tea strainer with fine holes: designed for even the smallest tea leaves.
- The cleverly designed anti-drip spout prevents leakage when pouring.
- The extra wide base allows you to use it on all types of hobs (including induction).
- The aroma of fresh tea is subtly dispersed through the small steam hole in the lid.
- Fold-down handle makes storage neat and efficient.

5-year guarantee





Ø	Product No	Description	Vol.(L) / Cap	Pack	Barcode
12 cm	30004688	TEA KETTLE - AUBERGINE RED Colour box	0,7	8	5410577130942
12 cm	30004687	TEA KETTLE - PINE GREEN Colour box	0,7	8	5410577130935
12 cm	30004689	TEA KETTLE - MUSTARD YELLOW Colour box	0,7	8	5410577130959





SETS

∅	Product No	Description	Vol.(L) / Cap	Pack	Barcode
---	------------	-------------	---------------	------	---------

**INDU + (COOKING PLEASURE)
5-8 PCS SET**







	30005095	Colour box		2	5410577133721
18 cm		saucepan with lid	2,0		
20 cm		casserole with lid	2,5		
24 cm		casserole with lid	4,5		
20 cm		frying pan non-stick	2 		
28 cm		frying pan non-stick	4 		
		+ 2 free pan protectors			

**INDU + (START TO COOK)
4-7 PCS SET**



	30004651	Colour box		2	5410577130737
16 cm		saucepan with lid	1,4		
20 cm		casserole with lid	2,5		
24 cm		casserole with lid	4,5		
24 cm		frying pan non-stick	3 		



Ø	Product No	Description	Vol.(L) / Cap	Pack	Barcode
					
FUTURA RECYCLED 4-7 PCS SET					
	100145	Colour box saucepan casserole with lid casserole with lid casserole with lid	1,0 1,5 2,1 3,0	2	5410577029468
14 cm 16 cm 18 cm 20 cm					
ENJOYMENT 4-7 PCS SET					
	30004793	Colour box saucepan with lid casserole with lid stockpot with lid frying pan non-stick	1,4 2,8 4,4 3	2	5410577131727
16 cm 20 cm 24 cm 24 cm					
	30004848	Colour box saucepan casserole with lid casserole with lid casserole with lid	1,6 2,0 3,0 5,1	2	5410577132264
16 cm 16 cm 20 cm 24 cm					



MARKETING SUPPORT.

Looking for Brabantia marketing support in your shop or showroom? We have some ready-to-use items or can work something out custom-made! Don't hesitate to contact your Brabantia cookware sales person.

FRYING PAN DISPLAY

Ref. 12010740

H = 1670 mm

H incl. headerboard = 2190 mm



HEADERBOARD



Brabantia Balance

Ref. 12012820

H = 420 mm

W = 590 mm



BOUTIQUE DISPLAY

Ref. 12013850

2100 x 600 x 1000 mm



COUNTER CARDS (A4)

Brabantia Indu+

Ref. 12013000

H = 297 mm

W = 210 mm



Brabantia The Dutch

Ref. 12013930

H = 297 mm

W = 210 mm



Brabantia T-Time

Ref. 12013020

H = 297 mm

W = 210 mm



X Cube Pedal Bin

- High quality brushed stainless steel for a refined, sleek look
- Antibacterial clear coating on stainless steel and germ resistant inner bucket, for maximum hygiene
- Removable inner bucket for easy bag change and cleaning
- Space efficient design that fits perfectly against a wall
- Fingerprint resistant
- Durable pedal mechanism, tested to last more than 100,000 times
- Deodorizer compartment, to hold an EKO carbon odour filter or a perfume capsule
- Silicone seal to keep odours inside the bin
- Soft close lid
- Movable frame lifts up to keep the lid open
 - to help with longer tasks and make bag changing easy
- Bin bag fixer holds any size bag in place. So no more shopping around for the 'perfect' bin liners
- 10 year guarantee



Product No	Size	Pack
EK9368MT-45L	45L	1

Ecocasa III Essential Recycler Pedal Bin

- High quality brushed stainless steel
- Space efficient design, fits perfectly against a wall
- Two colour coded, removable inner buckets with handles, to help easily separate waste
- Stay open lid
- Durable pedal mechanism and soft close lid
- Fingerprint resistant
- Bin bag fixer holds any size bag in place. So no more shopping around for the 'perfect' bin liners
- 3 year guarantee



Product No	Colour	Size	Pack
EK8228MT-20/20L	Stainless Steel	20L+20L	1
EK8228MBL-20/20L	Black	20L+20L	1

Ecocasa Recycling Pedal Bin



- High quality brushed stainless steel
- Space efficient design, fits perfectly against a wall
- Two colour coded, removable inner buckets with handles, to help easily separate waste
- Slim, stay open lid
- Durable pedal mechanism and soft close lid
- Fingerprint resistant
- Bin bag fixer holds any size bag in place
- 3 year guarantee



Product No	Size	Pack
EK9128MT-15/15L	15L+15L	1

Ecofly Step Bin



- High quality brushed stainless steel with a fingerprint resistant finish for a refined, sleek look
- Removable inner bucket, for easy bag changing and cleaning
- Durable pedal mechanism and soft close lid, tested to last more than 100,000 times
- Built in wheels and hidden handle for easy movement
- Space efficient design with dual opening lid
- Fits perfectly against the wall and under the counter
- Bin bag fixer holds any size bag or bin liner in place, and also hides any messy overhang from bags
- 5 year guarantee



Product No	Size	Pack
EK9377MT-30L	30L	1

Eva Step Bin

- High quality fingerprint resistant stainless steel
- Removable inner bucket for easy cleaning, bag changing and waste disposal
- Slim, stay open lid
- Durable pedal mechanism and soft close lid
- Bin bag fixer holds any size bag in place
- 3 year guarantee



Product No	Colour	Size	Pack
EK9115MT-5L	Stainless Steel	5L	4
EK9115WH-5L	White	5L	4
EK9115MT-30L	Stainless Steel	30L	1



Stella Step Bin

- High quality stainless steel
- Removable inner bucket for easy cleaning, bag changing and waste disposal
- Bin bag fixer holds any size bag in place. So no more shopping around for the 'perfect' bin liners
- Slim, stay open lid
- Durable pedal mechanism and soft close lid
- 3 year guarantee



Product No	Size	Pack
EK9384MT-30L	30L	1



Mirage X Sensor Bin



- High quality brushed stainless steel with a fingerprint resistant finish for a refined, sleek look
- Interactive motion sensor for effortless and hygienic hands-free operation
- Dynamic blue light display for simple interface with manual mode
- Option for touch manual opening and stay open, for longer tasks
- Soft close lid
- No inner bucket to allow full use of the large 80L capacity
- Lid designed to hide excess bin liner keeping the bin looking neat and tidy at all times
- Fingerprint resistant
- Built in deodorizer compartment compatible with our perfume capsules
- 3 year guarantee



Product No	Size	Pack
EK9260MT-80L	80L	1

Mirage X Recycling Sensor Bin



- High quality brushed stainless steel with a fingerprint resistant finish for a refined, sleek look
- Interactive motion sensor for effortless and hygienic hands-free operation
- Dynamic blue light display for simple interface with manual mode
- Option for touch manual opening and stay open, for longer tasks
- Soft close lid
- Two removable inner buckets for easy cleaning
- Lid designed to hide excess bin liner keeping the bin looking neat and tidy at all times
- Fingerprint resistant
- Built in deodorizer compartment compatible with our perfume capsules
- 3 year guarantee



Product No	Size	Pack
EK9260MT-20L/20L	20L+20L	1

Morandi Touch Bin

- Slim, interlocking design, so they sit flush next to each other, against a wall or in a corner
- Six stickers included for customisation and easy identification of bins for recycling requirements
- Easy, touch open lid – which stays open for longer tasks
- Removable inner rim to hold bags in place
- Space efficient
- Anti-slip ridged base
- Dark grey in colour



Product No	Size	Pack
EK6187DG-30L	30L	4
EK6187DG-40L	40L	4

Bin Perfume Starter Set

- Eradicate unpleasant bin smells
- The self-adhesive device sticks firmly to the underside of household bin lids to mask odours and keep bins smelling fresh at all times
- Suitable for sensor or pedal bins excluding Ecofly 30L
- 3M adhesive tape that leaves no residue
- Robust yet neat design
- Special membrane filter for effective perfume diffusion



Product No	Pack
EK8180/8011	10

Puro Compostable Waste Caddy

- Small enough to keep on a kitchen counter
- Handy hook for hanging over cabinet doors
- Includes 3M sticky pad for mounting on walls
- Antibacterial properties to keep it hygienic and easy to clean
- Outer frame to keep bin liners tidy and secure
- Removable lid for easy waste disposal
- Robust handle for carrying



Product No	Colour	Size	Pack
EK6011DG-3L	Grey	3L	12



Deco Compostable Waste Caddy



- Small enough to keep on a kitchen counter
- Antibacterial properties to keep it hygienic and easy to clean
- Stay open lid for easy waste disposal
- Inner frame to keep bin bags secure



Product No	Colour	Size	Pack
EK6010-TB	Blue	4L	8
EK6010-CR	Grey	4L	8

Compostable Waste Bags

- Made primarily from natural cornstarch which is fully compostable within 180 days
- Suitable for 3-6L bins and food caddies
- 20 bags per pack



Product No	Size	Per Roll	Pack
EK33201	3-6L	20 Pieces	48

Bin Liners

- Tear free roll pack, for easy opening
- Unlike many others, EKO bin liners are not attached to each other
- Integrated drawstring handles so they are easy to lift, tie and carry



Product No	Size	Per Roll	Pack
EK33701	Size A 3-6L	30 Pieces	48
EK33703	Size C 10-15L	20 Pieces	48
EK33705	Size E 25-35L	12 Pieces	24
EK33706	Size F 40-60L	12 Pieces	24
EK33706-1	Size F-1 18-28L	20 Pieces (Double Liner)	24
EK33707	Size G 50-90L	10 Pieces	24

Systema Waste Bin 10L+23L

- Made of recycled material
- Equipped with 2 practical inserts
- Each has solid ABS handles, a removable leg base and a wall hanger



Product No	Colour	Size	Pack
NKS45W2-S411	Black	10L+23L	1
NKS45W2-427C	Ashen Grey	10L+23L	1

Systema Waste Bin 10L+10L+23L

- Made of recycled material
- Equipped with 3 practical inserts
- Each has solid ABS handles, a removable leg base and a wall hanger



Product No	Colour	Size	Pack
NKS60W3-S411	Black	10L+10L+23L	1
NKS60W3-427C	Ashen Grey	10L+10L+23L	1

Zanzi Basket

- The harmony of proportions and elegant shape make this basket an ideal complement for every interior
- Made of a lightweight yet durable material
- Easy to clean
- Weatherproof



Product No	Colour	Size	Pack
IKPIR380-S433	Anthracite	374mm	3
IKPIR380-7501U	Straw	374mm	3
IKPIR430-S433	Anthracite	430mm	5
IKPIR430-7501U	Straw	430mm	5

Zoe Basket

- The harmony of proportions and elegant shape make this basket an ideal complement for every interior
- Made of a lightweight yet durable material
- Easy to clean
- Weatherproof



Product No	Colour	Size	Pack
IKPIO370-S433	Anthracite	364mm	3
IKPIO370-7501U	Straw	364mm	3
IKPIO430-S433	Anthracite	419mm	5
IKPIO430-7501U	Straw	419mm	5

Classic Display Stand

- Available in 3 sizes in black or clear



Product No	Colour	Size	Pack
CS04BL	Black	8-15cm/3-6 inch	12
CS04CL	Clear	8-15cm/3-6 inch	12
CS07BL	Black	15-25cm/6-10 inch	12
CS07CL	Clear	15-25cm/6-10 inch	12
CS11BL	Black	25-45cm/10-18 inch	6
CS11CL	Clear	25-45cm/10-18 inch	6

Wooden Display Stand

- Available in 3 sizes in an attractive Walnut finish

Product No	Colour	Size	Pack
WS04WL	Walnut	8-15cm/3-6 inch	6
WS07WL	Walnut	15-25cm/6-10 inch	6
WS10WL	Walnut	25-45cm/10-18 inch	6



Clip Display Stand

- A versatile folding stand with unique locking mechanism



Product No	Colour	Size	Pack
CLSMBL	Black	13cm/5 inch	40
CLSMCL	White	13cm/5 inch	40
CLMEBL	Black	19cm/7.5 inch	40
CLMECL	White	19cm/7.5 inch	40
CLLGBL	Black	26cm/10 inch	40
CLLGCL	White	26cm/10 inch	40

Wire Struts

- Plastic coated



Product No	Colour	Size	Pack
ST01WL	White	6cm/2.5 inch	12
ST02WL	White	10cm/4 inch	12
ST03WL	White	14cm/5.5 inch	12
ST04WL	White	17cm/7 inch	12

Disc Plate Hanger

- Adhesive plate hanger
- Supplied with hanging hook and nail



Product No	Size	Pack
DS01PL	3cm/1 inch	10
DS02PL	5cm/2 inch	10
DS03PL	7.5cm/3 inch	10
DS04PL	10cm/4 inch	10
DS05PL	14cm/5 inch	10

Plate Wire Hanger

Product No	Size	Pack
PW10WL	9-13cm/3.5-5 inch	12
PW20WL	13-19cm/5-7.5 inch	12
PW30WL	19-25cm/7.5-10 inch	12
PW40WL	25-36cm/10-14 inch	12
PW50WL	36-46cm/14-18 inch	12



- White plastic coated plate wire hangers
- Available in 5 sizes



Hug  Rug[®]

ECO-FRIENDLY PRODUCTS MADE WITH LOVE

Everyone loves a Hug

FROM WASTE TO WONDERFUL



WE WORK HARD YEAR ON YEAR TO MAKE OUR HUG RUGS AS ENVIRONMENTALLY FRIENDLY AS POSSIBLE. WE RECYCLE OVER...



6.6
MILLION
T-SHIRTS
PER YEAR IN THE
COTTON TUFTS



16
MILLION
PLASTIC BOTTLES
PER YEAR TO
CREATE THE EXTRA
TOUGH MEMBRANE



192
TONNES
RECYCLED
INDUSTRIAL
PLASTIC PER YEAR
IN OUR BACKING

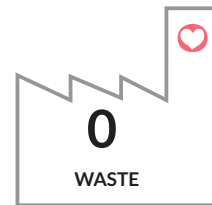

0
WASTE
TO LANDFILL FROM
OUR YORKSHIRE
MILLS

THE MAT WITH A HEART

- ♥ RECYCLED CONTENT
- ♥ TRAPS UP TO 95% DUST DIRT AND MUD
- ♥ GENUINELY MANUFACTURED IN THE UK
- ♥ ULTRA ABSORBENT
- ABSORBS UP TO 3X ITS OWN WEIGHT IN WATER
- ♥ WASHABLE AT 30°C
- ♥ 5 YEAR MANUFACTURER GUARANTEE
- ♥ LARGE RANGE OF PLAINS AND PATTERNS
- ♥ HARD WEARING, NON SLIP RUBBER BACKING WITH RECYCLED CONTENT

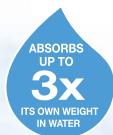

Our Hug Rugs are flying out of the door and the demand just keeps on growing



THEY LOOK GREAT, BUT BEST OF ALL... THEY WORK!



HOW DO THEY WORK SO WELL?

Hug Rug® Traps up to 95% of dust, wet mud and dirt – The special cotton fibres soak up moisture which reduces any slip hazards from wet floors and gets deep into the tread of shoes and paws, so protecting carpets and floors and reducing cleaning. They are easy to clean and become more absorbent with each wash.

Hug Rug® is manufactured using recycled cotton which is then combined with a new advanced **microfibre**, which is thinner than a human hair. This microfibre is extremely clever and is able to attract dirt and dust molecules very efficiently, in fact they can absorb over 3 times their own weight in water or liquid without letting any water through onto the floor! This means that not only will it clean better, but the mat itself will have a smaller environmental footprint due to the reduced amount of water required to launder it. Microfibre is a hypoallergenic material that is easily cleaned between uses – so eliminating the possibility of bringing external allergens into your home. Simplicity itself to clean and washes at 30°C. Another environmental benefit is the increased life of a microfibre mat when compared to a standard cotton mat; longer life means less resources used to create new mats!

HERE'S THE CLEVER BIT

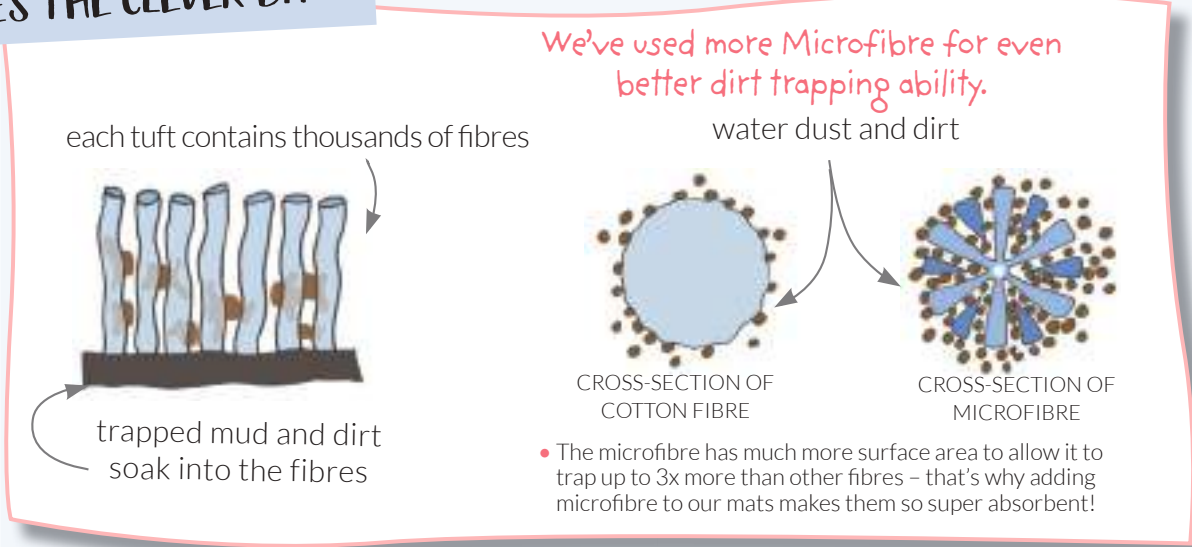

Due to the nature of the materials used 'recycled' content may vary, but always with a minimum of 70% recycled cotton (to 30% recycled microfibre). We are always looking for ways to improve our products and we reserve the right to change specifications, colours and materials shown in our brochures and on our website or to withdraw products without prior notice.

HOW DO WE MAKE THEM?



From the outset the Hug Rug® range has been created and developed to be as environmentally friendly as possible. From the sourcing of raw materials, the development of entirely new manufacturing processes, using cleaner/ greener sources of electricity made by hydro pumps, windmill farms and solar, through to its eventual disposal and recycling – everything has been considered to ensure Hug Rug® has a light environmental footprint, it can even be washed at 30°C.

- Face fabric – up to 90% cotton recycled from the clothing industry combined with micro fibres
- Base fabric – made from recycled drink bottles and bottle tops
- Reverse – rubber backing containing renewable rubber and recycled plastics

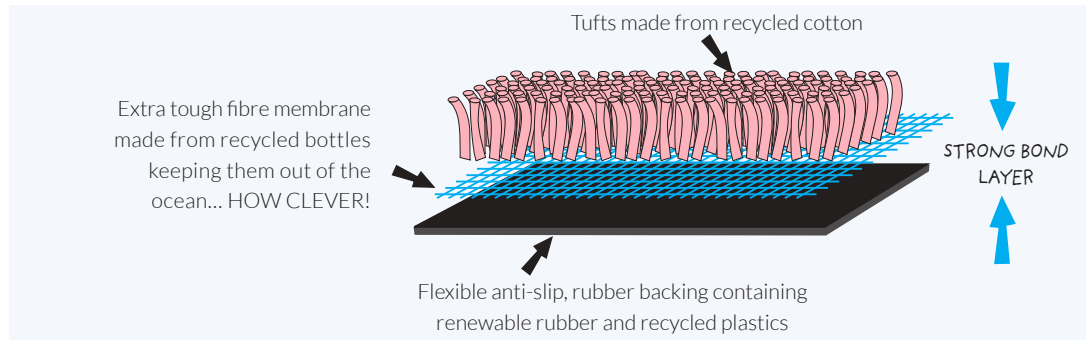

OUR BACKING

Our barrier mats have an *ECO-GENICS* backing as standard



RECYCLED CONTENT: At Hug Rug we have always looked for the best way of preventing harmful waste, as part of that we have invested in technology that allows us to add renewable rubber and post industrial plastics into the rubber backing therefore saving over 100 tonnes of plastic per year going to landfill and damaging our environment.

ECO-GENICS – rubber backing with recycled content:

- **LONG LASTING:** Heavyweight rubber combined with a specially designed extra strong, fibre membrane to bond the fibres to the backing
- **ANTI-SLIP** – Waffle design combined with soft latex rubber allows grip on hard polished surfaces to stop the mat from slipping
- **ANTI-STAIN:** Our stable rubber compound backing is designed not to leave marks, is non-damaging and contains non-staining antioxidants. Our backing is also free from both vinyl & PVC

LOOKING AFTER YOUR HUG RUG

Please follow these instructions and you will be able to love your mat for even longer!

- Only wash the Hug Rug when necessary.
- New Hug Rugs may shed excess cotton, this is normal and will stop once it has been brushed a few times or washed.
- To save water – allow mud and dirt to dry and then simply brush it away.
- To give the rug a longer life place it in a cotton pillow case, wash on a quick cotton wash at 30°C with drum at a low spin speed.
- Excess cotton may arise in filter – so check filter on washing machine regularly.
- Do not use biological washing detergent as this may fade the colour.
- Do not use fabric conditioner as this will reduce the effect of its performance.
- Flat, Aga rail or line dry naturally. The Hug Rug can be tumble dried on a cool setting for 10 minutes to push the pile – optional.
- Never place a Hug Rug on a damp floor or in tumble dryer on high heat setting for long period of time.
- As with any soft furnishings – if left in direct sunlight the colour will fade.

Our mats are designed not to leave marks, however a combination of cleaning products, sunlight & heat may effect and/or cause discolouration to certain types of flooring when covered. We would advise you to please lift the mat frequently to allow the floor under the mat to be cleaned and aired. Our backing is a natural based product free from vinyl & PVC. For specialist flooring please check with the manufacturer before using any rubber backed mats.



♥ PLAIN FLECK

These are our best selling **Hugobug**'s plain and simple. A range that blends into any home setting and helps to keep homes cleaner and more hygienic. The fleck design are made from a mix of coloured recycled cotton fibres in attractive colour palettes to create a fleck design which helps to disguise mud and dirt.



♥ COTTON RICH FACE TRAPS
UP TO 95% DUST, DIRT & MUD

♥ EASY CARE, MACHINE
WASHABLE ON COOL WASH

♥ ANTI-SLIP, HEAVY WEIGHT
RUBBER BACKING





All our rubber backed mats have patented technology to help reduce noise & echo



PATENT: GB 2591974 B



Product No	Colour	Size	Pack
PT621404	Beige	50cm x 75cm	1
PT621411	Beige	80cm x 100cm	1
PT621428	Beige	65cm x 150cm	1



Product No	Colour	Size	Pack
PT621442	Soft Green	50cm x 75cm	1
PT621459	Soft Green	80cm x 100cm	1
PT621466	Soft Green	65cm x 150cm	1



Product No	Colour	Size	Pack
PT010017	Linen	50cm x 75cm	1
PT010512	Linen	80cm x 100cm	1
PT010314	Linen	65cm x 150cm	1



Product No	Colour	Size	Pack
PT012011	Coffee	50cm x 75cm	1
PT012516	Coffee	80cm x 100cm	1
PT012318	Coffee	65cm x 150cm	1



Product No	Colour	Size	Pack
PT011014	Stone	50cm x 75cm	1
PT011519	Stone	80cm x 100cm	1
PT011311	Stone	65cm x 150cm	1

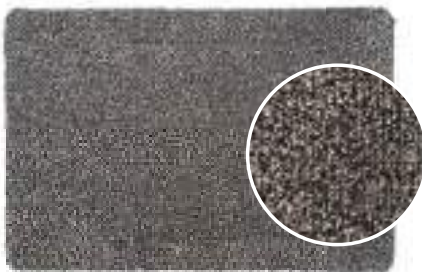

Product No	Colour	Size	Pack
PT013018	Slate	50cm x 75cm	1
PT013513	Slate	80cm x 100cm	1
PT013315	Slate	65cm x 150cm	1

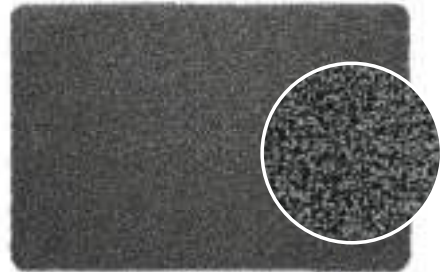

Product No	Colour	Size	Pack
PT014015	Charcoal	50cm x 75cm	1
PT014510	Charcoal	80cm x 100cm	1
PT014312	Charcoal	65cm x 150cm	1



Product No	Colour	Size	Pack
PT802124	Terracotta	50cm x 75cm	1
PT802179	Terracotta	80cm x 100cm	1
PT802223	Terracotta	65cm x 150cm	1

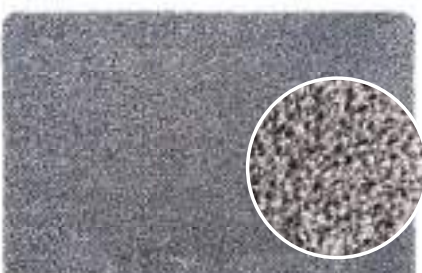

Product No	Colour	Size	Pack
PT517752	Light Grey	50cm x 75cm	1
PT517769	Light Grey	80cm x 100cm	1
PT517776	Light Grey	65cm x 150cm	1

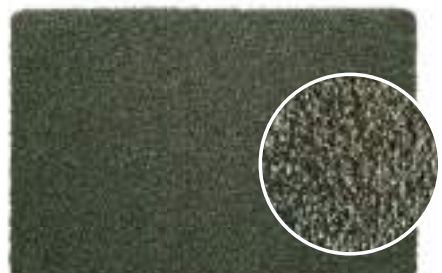

Product No	Colour	Size	Pack
PT010055	Sage Green	50cm x 75cm	1
PT010109	Sage Green	80cm x 100cm	1
PT010154	Sage Green	65cm x 150cm	1



Product No	Colour	Size	Pack
PT596016	Indigo	50cm x 75cm	1
PT596030	Indigo	80cm x 100cm	1
PT596023	Indigo	65cm x 150cm	1

CANDY RANGE



Our Original Plains have such a great range of colours that we've created these gorgeous candy mats using a mixture of the plain fleck fibres to create subtle stripes and zig zags, so if you can't decide which is your favourite plain colour, try one of these...

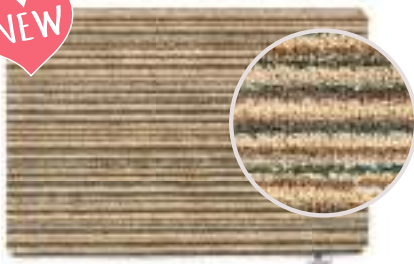

Product No	Design	Size	Pack
PT621480	Candy Earth	50cm x 75cm	1
PT621497	Candy Earth	80cm x 100cm	1
PT621503	Candy Earth	65cm x 150cm	1



Product No	Design	Size	Pack
PT621527	Candy Green	50cm x 75cm	1
PT621534	Candy Green	80cm x 100cm	1
PT621541	Candy Green	65cm x 150cm	1



Product No	Design	Size	Pack
PT524606	Candy Rocks	50cm x 75cm	1
PT524613	Candy Rocks	80cm x 100cm	1
PT524620	Candy Rocks	65cm x 150cm	1



Product No	Design	Size	Pack
PT018112	Candy Stripe	50cm x 75cm	1
PT018518	Candy Stripe	80cm x 100cm	1
PT017313	Candy Stripe	65cm x 150cm	1



Product No	Design	Size	Pack
PT010024	Candy Sage	50cm x 75cm	1
PT010079	Candy Sage	80cm x 100cm	1
PT010123	Candy Sage	65cm x 150cm	1



Product No	Design	Size	Pack
PT010048	Candy Slate	50cm x 75cm	1
PT010093	Candy Slate	80cm x 100cm	1
PT010147	Candy Slate	65cm x 150cm	1

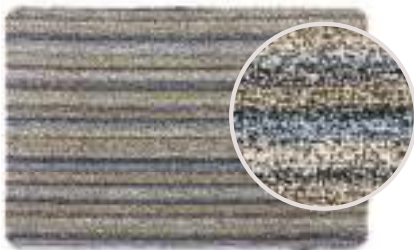

Product No	Design	Size	Pack
PT524644	Ribbon Grey	50cm x 75cm	1
PT524651	Ribbon Grey	80cm x 100cm	1
PT524668	Ribbon Grey	65cm x 150cm	1

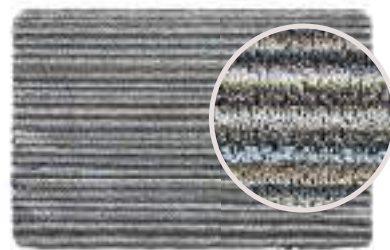

Product No	Design	Size	Pack
PT027848	Portland Stripe	50cm x 75cm	1
PT027855	Portland Stripe	80cm x 100cm	1
PT027862	Portland Stripe	65cm x 150cm	1



Product No	Design	Size	Pack
PT027879	New England Stripe	50cm x 75cm	1
PT027886	New England Stripe	80cm x 100cm	1
PT027893	New England Stripe	65cm x 150cm	1



Product No	Design	Size	Pack
PT552791	Candy Zig Zag	50cm x 75cm	1
PT552852	Candy Zig Zag	80cm x 100cm	1
PT552913	Candy Zig Zag	65cm x 150cm	1



Product No	Design	Size	Pack
PT552838	Ribbon Grey Zig Zag	50cm x 75cm	1
PT552890	Ribbon Grey Zig Zag	80cm x 100cm	1
PT552951	Ribbon Grey Zig Zag	65cm x 150cm	1



Product No	Design	Size	Pack
PT550483	Portland Zig Zag	50cm x 75cm	1
PT550544	Portland Zig Zag	80cm x 100cm	1
PT550513	Portland Zig Zag	65cm x 150cm	1



CANDY EARTH



CANDY GREEN

Lovely designs made up of recycled cotton fibres all with anti viral/anti bacterial protection



CANDY STRIPE



CANDY SAGE



PORTLAND STRIPE



NEW ENGLAND STRIPE

Our mats are designed not to leave marks, however a combination of cleaning products, sunlight & heat may affect and / or cause discolouration to certain types of flooring when covered. We would advise you to please lift the mat frequently to allow the floor under the mat to be cleaned and aired. Our backing is a natural based product free from vinyl & PVC. For specialist flooring please check with the manufacturer before using any rubber backed mats.

HugobRug[®] SENSE

LUXURY ECO-FRIENDLY MATS



NEW



Product No	Colour	Size	Pack
PT620407	Beige	50cm x 75cm	1
PT620414	Beige	65cm x 100cm	1
PT620421	Beige	65cm x 150cm	1
PT620438	Beige	80cm x 120cm	1

NEW



Product No	Colour	Size	Pack
PT620445	Forest Green	50cm x 75cm	1
PT620452	Forest Green	65cm x 100cm	1
PT620469	Forest Green	65cm x 150cm	1
PT620476	Forest Green	80cm x 120cm	1



Product No	Colour	Size	Pack
PT555495	Charcoal	50cm x 75cm	1
PT555556	Charcoal	65cm x 100cm	1
PT555617	Charcoal	65cm x 150cm	1
PT555730	Charcoal	80cm x 120cm	1



Product No	Colour	Size	Pack
PT555501	Clove Brown	50cm x 75cm	1
PT555563	Clove Brown	65cm x 100cm	1
PT555624	Clove Brown	65cm x 150cm	1
PT555747	Clove Brown	80cm x 120cm	1



Product No	Colour	Size	Pack
PT555518	Ghost Grey	50cm x 75cm	1
PT555570	Ghost Grey	65cm x 100cm	1
PT555631	Ghost Grey	65cm x 150cm	1
PT555754	Ghost Grey	80cm x 120cm	1



Product No	Colour	Size	Pack
PT555532	Rose	50cm x 75cm	1
PT555594	Rose	65cm x 100cm	1
PT555655	Rose	65cm x 150cm	1
PT555778	Rose	80cm x 120cm	1



Product No	Colour	Size	Pack
PT555549	Stone	50cm x 75cm	1
PT555600	Stone	65cm x 100cm	1
PT555662	Stone	65cm x 150cm	1
PT555785	Stone	80cm x 120cm	1



Product No	Colour	Size	Pack
PT596054	French Navy	50cm x 75cm	1
PT596061	French Navy	65cm x 100cm	1
PT596078	French Navy	65cm x 150cm	1
PT596085	French Navy	80cm x 120cm	1



Product No	Colour	Size	Pack
PT596092	Pumice Stone	50cm x 75cm	1
PT596108	Pumice Stone	65cm x 100cm	1
PT596115	Pumice Stone	65cm x 150cm	1
PT596122	Pumice Stone	80cm x 120cm	1



Product No	Colour	Size	Pack
PT555525	Mink	50cm x 75cm	1
PT555587	Mink	65cm x 100cm	1
PT555648	Mink	65cm x 150cm	1
PT555761	Mink	80cm x 120cm	1



CUSTOMERS LOVE THEM...

Good job it's washable!



5 star customer review
 My Sense mat is very well made and looks luxurious at the front door. Very pleased indeed!

FJD



GHOST GREY

Stains and spills just wash off!



FOREST GREEN

British made and eco-friendly!



No shedding, stain resistant and washable

FRENCH NAVY



Super soft and hard wearing!

BEIGE

NUMBER OF RECYCLED BOTTLES (250ml) IN EACH SENSE MAT:

50 x 75cm = 115 bottles

65 x 150cm = 300 bottles

65 x 100cm = 200 bottles

80 x 120cm = 295 bottles





A GREAT COLLABORATION...



It's the perfect partnership! We are thrilled to be showcasing our NEW HERDY RANGE, two great Northern companies coming together to bring you these colourful designs that will make you smile and bring a sense of fun into your home.

Your customers will flock to these super cute designs...





made to make you smile

Product No	Design	Size	Pack
PT610538	Hello Grey	65cm x 85cm	1



Product No	Design	Size	Pack
PT610569	Hiker Herdy	65cm x 85cm	1



Product No	Design	Size	Pack
PT610545	Hello Ewe	65cm x 85cm	1

NEW



Product No	Design	Size	Pack
PT621022	Peep Stripe Herdy	65cm x 85cm	1



Product No	Design	Size	Pack
PT621039	Peep Stripe Herdy	65cm x 150cm	1

NEW



Product No	Design	Size	Pack
PT621046	Marra Grey Herdy	65cm x 85cm	1



Product No	Design	Size	Pack
PT621053	Marra Grey Herdy	65cm x 150cm	1



Product No	Design	Size	Pack
PT610583	Marra Herdy	65cm x 85cm	1



Product No	Design	Size	Pack
PT610576	Marra Herdy	65cm x 150cm	1



CUTE LITTLE HUGS

50cm x 75cm

We have listened to our customers and have now extended the little hug range of designs, ideal for smaller doorways...

Great sellers in a smaller size...



Product No	Design	Size	Pack
PT612112	Hello Ewe	50cm x 75cm	1



Product No	Design	Size	Pack
PT620063	Garden Multi Floral 2	50cm x 75cm	1



Product No	Design	Size	Pack
PT609723	Home 15	50cm x 75cm	1



Product No	Design	Size	Pack
PT620070	Meet You	50cm x 75cm	1



Product No	Design	Size	Pack
PT621565	Peep Stripe Herdy	50cm x 75cm	1



Product No	Design	Size	Pack
PT620339	Pheasant Green 2	50cm x 75cm	1



Product No	Design	Size	Pack
PT609730	Nature 17	50cm x 75cm	1



Product No	Design	Size	Pack
PT610903	Pet 10	50cm x 75cm	1



Product No	Design	Size	Pack
PT609716	Highland 1	50cm x 75cm	1



Product No	Design	Size	Pack
PT609747	Stripe 85	50cm x 75cm	1



Product No	Design	Size	Pack
PT610217	Home 45	50cm x 75cm	1

PATTERNED SIZE COMPARISON

- 1 50cm x 75cm
- 2 65cm x 85cm
- 3 65cm x 100cm
- 4 65cm x 150cm

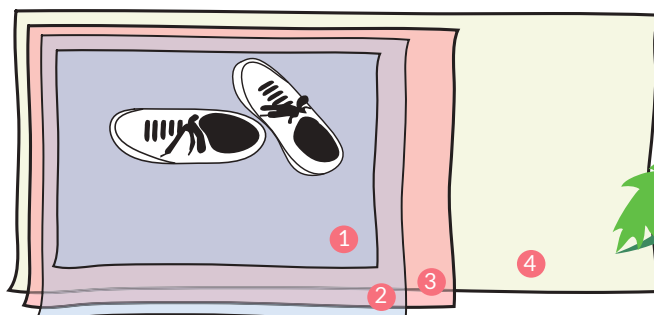



Ideal for internal doorways as well as front doors





Feast your eyes on our gorgeous range of British made, nature inspired Hug Rugs as well as charity, modern and pet designs which you will find throughout the brochure.



Product No	Design	Size	Pack
PT610729	Sunflower 1	65cm x 85cm	1



Product No	Design	Size	Pack
PT612051	Sunflower 1	65cm x 150cm	1



Product No	Design	Size	Pack
PT610613	Nature 29	65cm x 85cm	1



Product No	Design	Size	Pack
PT610620	Nature 29	65cm x 150cm	1



Product No	Design	Size	Pack
PT610514	Garden Multi Floral 2	65cm x 85cm	1



Product No	Design	Size	Pack
PT610521	Garden Multi Floral 2	65cm x 150cm	1



Product No	Design	Size	Pack
PT604223	Home 45	65cm x 85cm	1



Product No	Design	Size	Pack
PT604216	Home 45	65cm x 150cm	1



Everyone loves a hug and we have so many to choose from...



Product No	Design	Size	Pack
PT610507	Floral 5	65cm x 85cm	1



Product No	Design	Size	Pack
PT604230	Nature 22	65cm x 85cm	1



Product No	Design	Size	Pack
PT620315	Nature 50	65cm x 85cm	1



Product No	Design	Size	Pack
PT620322	Nature 50	65cm x 150cm	1



Product No	Design	Size	Pack
PT609273	Strawberries	65cm x 85cm	1



Product No	Design	Size	Pack
PT609280	Strawberries	65cm x 150cm	1



Product No	Design	Size	Pack
PT563865	Daisies 1	65cm x 85cm	1



Product No	Design	Size	Pack
PT563872	Daisies 1	65cm x 150cm	1





Hug Rugs to suit all styles of home...

NEW



Product No	Design	Size	Pack
PT620025	Nature 40	65cm x 85cm	1

NEW



Product No	Design	Size	Pack
PT620032	Nature 40	65cm x 150cm	1



Product No	Design	Size	Pack
PT524774	Nature 14	65cm x 85cm	1



Product No	Design	Size	Pack
PT524958	Nature 14	65cm x 150cm	1



Product No	Design	Size	Pack
PT538184	Home 34	65cm x 85cm	1



Product No	Design	Size	Pack
PT538191	Home 34	65cm x 150cm	1



Product No	Design	Size	Pack
PT563803	Mushroom 1	65cm x 85cm	1



Product No	Design	Size	Pack
PT563810	Mushroom 1	65cm x 150cm	1



ABSORBS
UP TO
3x
ITS OWN WEIGHT
IN WATER



358



WE LOVE
HUGS!



Our traditional favourites...

NEW



Product No	Design	Size	Pack
PT620254	Home 44	65cm x 85cm	1

NEW



Product No	Design	Size	Pack
PT620261	Home 44	65cm x 150cm	1



Product No	Design	Size	Pack
PT800946	Home 15	65cm x 85cm	1



Product No	Design	Size	Pack
PT800953	Home 15	65cm x 150cm	1



Product No	Design	Size	Pack
PT545847	Home 37	65cm x 85cm	1



Product No	Design	Size	Pack
PT545922	Home 37	65cm x 150cm	1



Product No	Design	Size	Pack
PT802797	Nature 12	65cm x 85cm	1



Product No	Design	Size	Pack
PT802803	Nature 12	65cm x 150cm	1

Throughout the brochure we have tried to replicate the mat colours as closely as possible, but colours may vary slightly from the pictures shown.

Have flowers and hugs all year round...



Product No	Design	Size	Pack
PT593152	Lemon & Lilies	65cm x 85cm	1



Product No	Design	Size	Pack
PT594142	Lemon & Lilies	65cm x 150cm	1



Product No	Design	Size	Pack
PT555853	Floral 3	65cm x 85cm	1



Product No	Design	Size	Pack
PT555860	Floral 3	65cm x 150cm	1



Product No	Design	Size	Pack
PT546707	Floral 2	65cm x 85cm	1



Product No	Design	Size	Pack
PT546714	Floral 2	65cm x 150cm	1



Product No	Design	Size	Pack
PT524804	Nature 17	65cm x 85cm	1



Product No	Design	Size	Pack
PT524989	Nature 17	65cm x 150cm	1









Product No	Design	Size	Pack
PT563933	Daffodil 1	65cm x 85cm	1



Product No	Design	Size	Pack
PT563940	Daffodil 1	65cm x 150cm	1



Product No	Design	Size	Pack
PT524781	Nature 15	65cm x 85cm	1



Product No	Design	Size	Pack
PT524965	Nature 15	65cm x 150cm	1



Product No	Design	Size	Pack
PT803374	Kitchen 16	65cm x 85cm	1



Product No	Design	Size	Pack
PT517912	Kitchen 16	65cm x 150cm	1



Product No	Design	Size	Pack
PT545878	Home 40	65cm x 85cm	1



Product No	Design	Size	Pack
PT545953	Home 40	65cm x 150cm	1



We love an English garden design...



Product No	Design	Size	Pack
PT604186	Topiary 31	65cm x 85cm	1



Product No	Design	Size	Pack
PT592964	Garden Floral 1	65cm x 85cm	1



Product No	Design	Size	Pack
PT610590	Nature 27	65cm x 85cm	1



Product No	Design	Size	Pack
PT610606	Nature 27	65cm x 150cm	1



Product No	Design	Size	Pack
PT610682	Nature 33	65cm x 85cm	1



Product No	Design	Size	Pack
PT610699	Nature 33	65cm x 150cm	1



Product No	Design	Size	Pack
PT604544	Garden Multi Floral	65cm x 85cm	1



Product No	Design	Size	Pack
PT604551	Garden Multi Floral	65cm x 150cm	1

WE RECYCLE...



...TO CREATE AN EXTRA TOUGH MEMBRANE



OOPS! Good job they are washable

MACHINE
30°C
WASHABLE



From William Morris inspired, to hand painted bugs and butterflies,
which is your favourite?



Product No	Design	Size	Pack
PT604247	Nature 25	65cm x 85cm	1



Product No	Design	Size	Pack
PT604629	Nature 25	65cm x 150cm	1



Product No	Design	Size	Pack
PT592988	Autumn Leaves	65cm x 85cm	1



Product No	Design	Size	Pack
PT592995	Autumn Leaves	65cm x 150cm	1



Product No	Design	Size	Pack
PT592940	Bugs & Butterflies	65cm x 85cm	1



Product No	Design	Size	Pack
PT594159	Bugs & Butterflies	65cm x 150cm	1



Product No	Design	Size	Pack
PT592926	Woodblock 1	65cm x 85cm	1



Product No	Design	Size	Pack
PT592933	Woodblock 1	65cm x 150cm	1

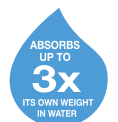





CHARITY MATS:



Our Bee mat was the first charity mat we did and it was such a huge success we have grown our charity range not only to include more Bee designs but for lots of other great charities too!



Product No	Design	Size	Pack
PT610439	Bee 3	65cm x 85cm	1



Product No	Design	Size	Pack
PT610446	Bee 3	65cm x 150cm	1



Product No	Design	Size	Pack
PT539518	Bee 1	65cm x 85cm	1



Product No	Design	Size	Pack
PT539525	Bee 1	65cm x 150cm	1



Product No	Design	Size	Pack
PT545816	Bee 2	65cm x 85cm	1



Product No	Design	Size	Pack
PT545892	Bee 2	65cm x 150cm	1



10% of sales from the mats and runners shown here go to Bumblebee Conservation Trust



Mummy says Hugs help to save the Bumble Bees





CHARITY MATS:



We all love birds and RSPB are another of our amazing charities, we are delighted to introduce our new Bluetit 1 design to the range. We use beautiful water colour illustrations to create these stunning mats, great for all bird and nature lovers.



Product No	Design	Size	Pack
PT619647	Bluetit 1	65cm x 85cm	1



Product No	Design	Size	Pack
PT610651	Owl 1	65cm x 85cm	1



Product No	Design	Size	Pack
PT610552	Heron 1	65cm x 85cm	1



Product No	Design	Size	Pack
PT610453	Birds 3	65cm x 85cm	1



Product No	Design	Size	Pack
PT595422	Nuthatch 1	65cm x 85cm	1



Product No	Design	Size	Pack
PT595439	Nuthatch 1	65cm x 150cm	1

10% of sales from the mats and runners shown here go to the RSPB

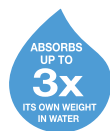



♥ MODERN DESIGNS

HugobRug® offer a range of contemporary designs to brighten your home, our spots and checks are always best sellers, ideal for adding colour to any home...

ANOTHER GREAT CHARITY,
2 FUN DESIGNS...



Product No	Design	Size	Pack
PT609310	Rainbow 2	65cm x 85cm	1



Product No	Design	Size	Pack
PT609297	Bright Spot 1	65cm x 85cm	1



Product No	Design	Size	Pack
PT609303	Bright Spot 1	65cm x 150cm	1



Product No	Design	Size	Pack
PT619395	Chevron 1	65cm x 85cm	1



Product No	Design	Size	Pack
PT619401	Chevron 1	65cm x 150cm	1



Product No	Design	Size	Pack
PT619425	Designer 25	65cm x 85cm	1



Product No	Design	Size	Pack
PT619432	Designer 25	65cm x 150cm	1



Product No	Design	Size	Pack
PT620292	Designer 27	65cm x 85cm	1



Product No	Design	Size	Pack
PT620308	Designer 27	65cm x 150cm	1





IDEAL ALL YEAR ROUND

NEW



Product No	Design	Size	Pack
PT621572	Stripe Red 2	65cm x 85cm	1

NEW



Product No	Design	Size	Pack
PT621589	Stripe Red 2	65cm x 150cm	1



Product No	Design	Size	Pack
PT604209	Designer 20	65cm x 85cm	1



Product No	Design	Size	Pack
PT604193	Designer 20	65cm x 150cm	1



Product No	Design	Size	Pack
PT610484	Designer 22	65cm x 85cm	1



Product No	Design	Size	Pack
PT610491	Designer 22	65cm x 150cm	1



Product No	Design	Size	Pack
PT800014	Check 10	65cm x 85cm	1

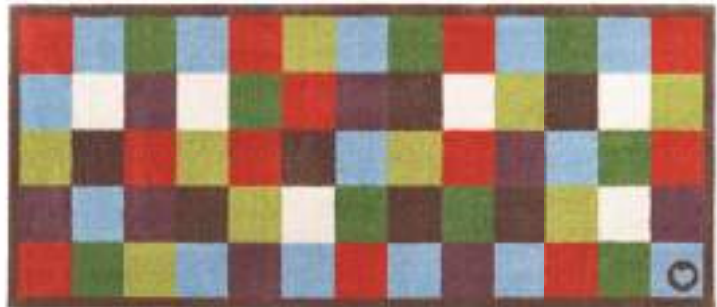

Product No	Design	Size	Pack
PT800540	Check 10	65cm x 150cm	1



Product No	Design	Size	Pack
PT800038	Spot 10	65cm x 85cm	1



Product No	Design	Size	Pack
PT800144	Spot 10	65cm x 150cm	1



Product No	Design	Size	Pack
PT801134	Spot 12	65cm x 85cm	1



Product No	Design	Size	Pack
PT803473	Spot 12	65cm x 150cm	1

He loves Hugs
I love treats!

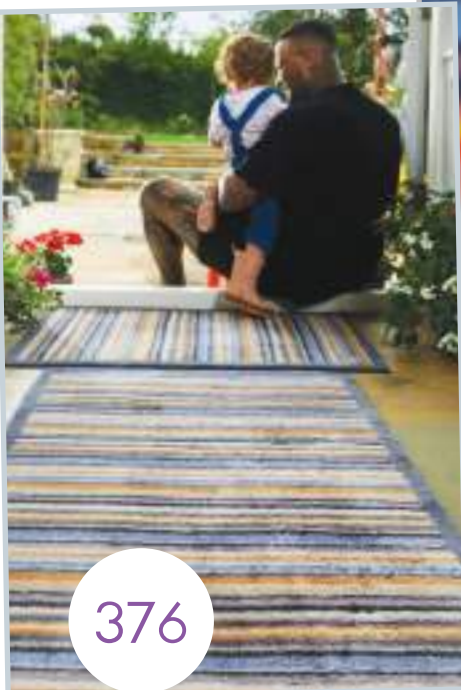

BRIGHTENS YOUR HOME INSTANTLY

**BEST
SELLER**



Product No	Design	Size	Pack
PT604346	Stripe 85	65cm x 85cm	1



Product No	Design	Size	Pack
PT604339	Stripe 85	65cm x 150cm	1



Product No	Design	Size	Pack
PT610705	Stripe 86	65cm x 85cm	1



Product No	Design	Size	Pack
PT610712	Stripe 86	65cm x 150cm	1



Product No	Design	Size	Pack
PT563780	Stripe 84	65cm x 85cm	1



Product No	Design	Size	Pack
PT563797	Stripe 84	65cm x 150cm	1



Product No	Design	Size	Pack
PT563766	Stripe 83	65cm x 85cm	1



Product No	Design	Size	Pack
PT563773	Stripe 83	65cm x 150cm	1



Product No	Design	Size	Pack
PT517790	Stripe 32	65cm x 85cm	1



Product No	Design	Size	Pack
PT526679	Stripe 32	65cm x 150cm	1



MACHINE
30°C
WASHABLE

It's made of things people throw away!





Product No	Design	Size	Pack
PT619807	Stripe 88	65cm x 85cm	1



Product No	Design	Size	Pack
PT619814	Stripe 88	65cm x 150cm	1



Product No	Design	Size	Pack
PT538320	Stripe 82	65cm x 85cm	1

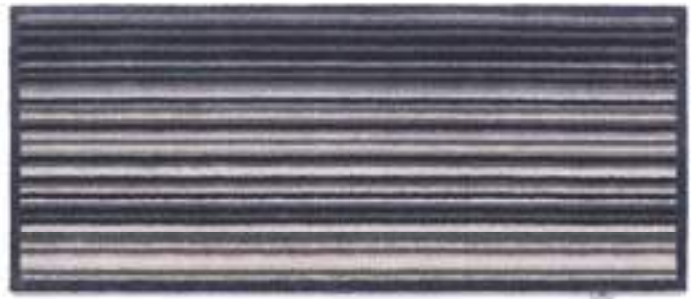

Product No	Design	Size	Pack
PT538337	Stripe 82	65cm x 150cm	1



Product No	Design	Size	Pack
PT800755	Designer 13	65cm x 85cm	1



Product No	Design	Size	Pack
PT800823	Designer 13	65cm x 150cm	1



Product No	Design	Size	Pack
PT800113	Stripe 70	65cm x 85cm	1



Product No	Design	Size	Pack
PT800533	Stripe 70	65cm x 150cm	1



Product No	Design	Size	Pack
PT802742	Stripe 26	65cm x 85cm	1



Product No	Design	Size	Pack
PT802759	Stripe 26	65cm x 150cm	1

COUNTRY COLLECTION



Introducing our gorgeous new Country range – everyone loves cute animals and these beautifully illustrated designs will add a warmth to any home, using a palette of colours perfect to brighten your room on the dreariest of days.



Product No	Design	Size	Pack
PT610460	Field Mice 1	65cm x 85cm	1



Product No	Design	Size	Pack
PT610477	Field Mice 1	65cm x 150cm	1



Product No	Design	Size	Pack
PT610668	Rabbit 1	65cm x 85cm	1



Product No	Design	Size	Pack
PT610675	Rabbit 1	65cm x 150cm	1



Product No	Design	Size	Pack
PT524750	Highland 1	65cm x 85cm	1



Product No	Design	Size	Pack
PT524934	Highland 1	65cm x 150cm	1



Product No	Design	Size	Pack
PT524712	Deer 1	65cm x 85cm	1



Product No	Design	Size	Pack
PT524910	Deer 1	65cm x 150cm	1



This is cute but when I said I wanted a bunny I meant a real one!



Add some character to your kitchen – non slip and super absorbent



Product No	Design	Size	Pack
PT620346	Pheasant Green 2	65cm x 85cm	1



Product No	Design	Size	Pack
PT620353	Pheasant Green 2	65cm x 150cm	1



Product No	Design	Size	Pack
PT524859	Pheasant 1	65cm x 85cm	1



Product No	Design	Size	Pack
PT525023	Pheasant 1	65cm x 150cm	1



Product No	Design	Size	Pack
PT538283	Sheep 1	65cm x 85cm	1



Product No	Design	Size	Pack
PT538290	Sheep 1	65cm x 150cm	1



Product No	Design	Size	Pack
PT524743	Hedgehog 1	65cm x 85cm	1



Product No	Design	Size	Pack
PT545809	Hedgehog 1	65cm x 150cm	1



They get better with every wash



Product No	Design	Size	Pack
PT524705	Chicken 1	65cm x 85cm	1



Product No	Design	Size	Pack
PT524903	Chicken 1	65cm x 150cm	1



Product No	Design	Size	Pack
PT538160	Hare 1	65cm x 85cm	1



Product No	Design	Size	Pack
PT538177	Hare 1	65cm x 150cm	1

PET RANGE

We all love pets but they are no good at wiping their paws, so **HugRug®** is perfect for stopping those muddy paw prints in their tracks.



Product No	Design	Size	Pack
PT610422	Meet You	65cm x 85cm	1



Product No	Design	Size	Pack
PT610422	Pet 95	65cm x 85cm	1



Product No	Design	Size	Pack
PT621091	Pet 95	65cm x 150cm	1



Product No	Design	Size	Pack
PT619449	Check 1	65cm x 85cm	1



Product No	Design	Size	Pack
PT619456	Check 1	65cm x 150cm	1



Product No	Design	Size	Pack
PT802834	Pet 60	65cm x 85cm	1



Product No	Design	Size	Pack
PT538238	Pet 60	65cm x 150cm	1



Product No	Design	Size	Pack
PT800434	Pet 10	65cm x 85cm	1



Product No	Design	Size	Pack
PT528116	Pet 10	65cm x 150cm	1

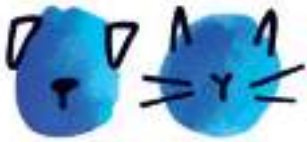

BATTERSEA

HERE FOR EVERY DOG AND CAT

CHARITY MAT DESIGNS

Produced under license from Battersea Dogs Home Ltd to go towards supporting the work of Battersea Dogs & Cats Home (registered charity no 206394). For all licensed products sold by Phoenix Textiles Limited, Phoenix will donate a minimum of £2,500 to Battersea Dogs Home Ltd, which gives all its distributable profits to Battersea Dogs & Cats Home.



Non-slip and machine washable - just what you need with muddy pets!





Product No	Design	Size	Pack
PT524811	Pet 45	65cm x 85cm	1



Product No	Design	Size	Pack
PT529564	Pet 45	65cm x 150cm	1



Product No	Design	Size	Pack
PT604261	Pet 70	65cm x 85cm	1



Product No	Design	Size	Pack
PT604254	Pet 70	65cm x 150cm	1



Product No	Design	Size	Pack
PT604285	Pet 75	65cm x 85cm	1



Product No	Design	Size	Pack
PT604278	Pet 75	65cm x 150cm	1

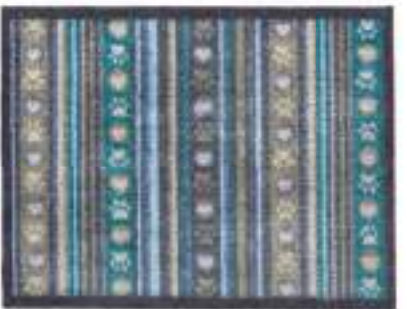

Product No	Design	Size	Pack
PT604308	Pet 80	65cm x 85cm	1



Product No	Design	Size	Pack
PT604292	Pet 80	65cm x 150cm	1



Product No	Design	Size	Pack
PT604322	Pet 85	65cm x 85cm	1



Product No	Design	Size	Pack
PT604315	Pet 85	65cm x 150cm	1

Don't look at me...
It was him!



♥ OUTDOOR RANGE



Drain holes in the backing allow the water to escape!

GORGEOUS DOORSTEP COIR TO GIVE A WARM WELCOME TO YOUR VISITORS



LOVE THE OUTDOORS – BUT KEEP IT OUTSIDE!

Scrape the mud off your boots before going indoors

Our plain outdoor mats are made in the UK

PLAIN OUTDOOR MATS

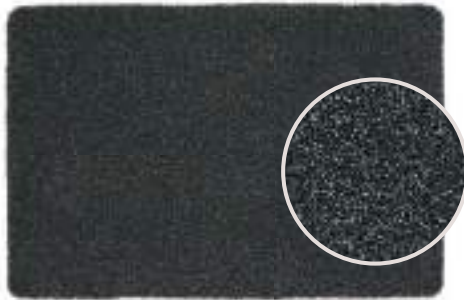

CHARCOAL



COFFEE



CHARCOAL RUNNER

Product No	Colour	Size	Pack
PT800427	Coffee	50cm x 70cm	1
PT801448	Charcoal	50cm x 70cm	1
PT521032	Coffee	60cm x 80cm	1
PT521049	Charcoal	60cm x 80cm	1
PT547094	Coffee	65cm x 130cm	1
PT547100	Charcoal	65cm x 130cm	1

PRINTED COIR MATS



NATURAL



HARD WEARING



ECO FRIENDLY



Please see pages 243 - 247 for our full range of coir designs



HUG RUG MERCHANDISING



Minimum order quantities apply to orders of display stands

Please contact your account manager for details



HUG RUG: 4 ARM DISPLAY STAND
 SIZE (cm) 190 wide x 80 deep x 195 high
 (including side hanging, excluding header graphic)



HUG RUG: 4 ARM DISPLAY STAND
 SIZE (cm): 100 wide x 100 deep x 240 high



HUG RUG: WALL UNITS
 SIZE (cm): 125 wide sections x 67 deep x 220 high



HUG RUG OR SENSE: WATERFALL DISPLAY STAND
 SIZE (cm): 66 wide x 68 deep x 210 high



SENSE: 4 ARM DISPLAY STAND
 SIZE (cm): 100 wide x 100 deep x 240 high



HUG RUG WOVEN: DISPLAY STAND
 SIZE (cm): 160 wide x 60 deep x 200 high

Hugobug[®] WOVEN

PLANET FRIENDLY TEXTILES



PERFECT FOR INDOORS & OUTDOORS



DIAMOND DESIGN



This contemporary range that will never go out of fashion. Easy care, they are hard wearing, easy to spot clean and washable when necessary. Mix and match your look...

REVERSIBLE RUGS...

3 SIZES (cm): 80 x 150 120 x 170 160 x 230



DARK GREEN

CUDDLY THROWS...

ONE SIZE (cm): 130 x 180



WARM GREY

COZY CUSHIONS...

ONE SIZE (cm): 45 x 45



GREEN

SKY GREY

GOLD

Rugs, throws & cushions are available in all these lovely colours...



DARK GREEN

RUST

GREEN

WARM GREY

GOLD

CORAL PINK

SKY GREY

DENIM BLUE

NATURAL

ROSE

NAVY



RUGS

Product No	Colour	Size	Pack
PT540477	Natural	80cm x 150cm	1
PT540484	Natural	120cm x 170cm	1
PT540491	Natural	160cm x 230cm	1
PT540620	Sky Grey	80cm x 150cm	1
PT540637	Sky Grey	120cm x 170cm	1
PT540644	Sky Grey	160cm x 230cm	1
PT540774	Green	80cm x 150cm	1
PT540781	Green	120cm x 170cm	1
PT540798	Green	160cm x 230cm	1
PT540927	Rose	80cm x 150cm	1
PT540934	Rose	120cm x 170cm	1
PT540941	Rose	160cm x 230cm	1
PT541078	Navy	80cm x 150cm	1
PT541085	Navy	120cm x 170cm	1
PT541092	Navy	160cm x 230cm	1
PT541221	Gold	80cm x 150cm	1
PT541238	Gold	120cm x 170cm	1
PT541245	Gold	160cm x 230cm	1
PT561342	Coral Pink	80cm x 150cm	1
PT561359	Coral Pink	120cm x 170cm	1
PT561366	Coral Pink	160cm x 230cm	1
PT561496	Denim Blue	80cm x 150cm	1
PT561502	Denim Blue	120cm x 170cm	1
PT561519	Denim Blue	160cm x 230cm	1
PT562141	Warm Grey	80cm x 150cm	1
PT562158	Warm Grey	120cm x 170cm	1
PT562165	Warm Grey	160cm x 230cm	1
PT603455	Dark Green	80cm x 150cm	1
PT603462	Dark Green	120cm x 170cm	1
PT603479	Dark Green	160cm x 230cm	1
PT603486	Rust	80cm x 150cm	1
PT603493	Rust	120cm x 170cm	1
PT603509	Rust	160cm x 230cm	1

THROWS

Product No	Colour	Size	Pack
PT540507	Natural	130cm x 180cm	1
PT540651	Sky Grey	130cm x 180cm	1
PT540804	Green	130cm x 180cm	1
PT540958	Rose	130cm x 180cm	1
PT541108	Navy	130cm x 180cm	1
PT541252	Gold	130cm x 180cm	1
PT561373	Coral Pink	130cm x 180cm	1
PT561526	Denim Blue	130cm x 180cm	1
PT562172	Warm Grey	130cm x 180cm	1
PT601802	Dark Green	130cm x 180cm	1
PT601796	Rust	130cm x 180cm	1



CUSHIONS

Product No	Colour	Size	Pack
PT540514	Natural	45cm x 45cm	1
PT540668	Sky Grey	45cm x 45cm	1
PT540811	Green	45cm x 45cm	1
PT540965	Rose	45cm x 45cm	1
PT541115	Navy	45cm x 45cm	1
PT541269	Gold	45cm x 45cm	1
PT561380	Coral Pink	45cm x 45cm	1
PT561533	Denim Blue	45cm x 45cm	1
PT562189	Warm Grey	45cm x 45cm	1
PT601826	Dark Green	45cm x 45cm	1
PT601819	Rust	45cm x 45cm	1





HERRINGBONE DESIGN

This lovely zig zag is perfect to add a dash of colour and softness to any space indoor or outdoor! Easy care, they are hard wearing, easy to spot clean and washable when necessary. Mix and match your look...



REVERSIBLE RUGS...

3 SIZES (cm): 80 x 150 120 x 170 160 x 230

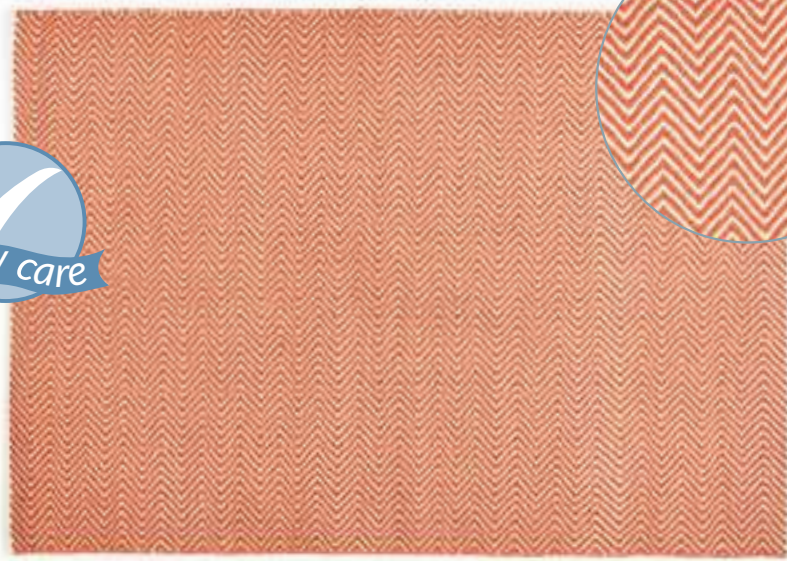

RUST

CUDDLY THROWS...

ONE SIZE (cm): 130 x 180



ROSE

COZY CUSHIONS...

ONE SIZE (cm): 45 x 45



ROSE

NAVY

NATURAL

Rugs, throws & cushions are available in all these lovely colours...



DARK GREEN



RUST



ROSE



CORAL PINK



NAVY



SKY GREY



GREEN



DENIM BLUE



NATURAL



WARM GREY



GOLD



RUGS

Product No	Colour	Size	Pack
PT540521	Natural	80cm x 150cm	1
PT540538	Natural	120cm x 170cm	1
PT540545	Natural	160cm x 230cm	1
PT540675	Sky Grey	80cm x 150cm	1
PT540682	Sky Grey	120cm x 170cm	1
PT540699	Sky Grey	160cm x 230cm	1
PT540828	Green	80cm x 150cm	1
PT540835	Green	120cm x 170cm	1
PT540842	Green	160cm x 230cm	1
PT540972	Rose	80cm x 150cm	1
PT540989	Rose	120cm x 170cm	1
PT540996	Rose	160cm x 230cm	1
PT541122	Navy	80cm x 150cm	1
PT541139	Navy	120cm x 170cm	1
PT541146	Navy	160cm x 230cm	1
PT541276	Gold	80cm x 150cm	1
PT541283	Gold	120cm x 170cm	1
PT541290	Gold	160cm x 230cm	1
PT561397	Coral Pink	80cm x 150cm	1
PT561403	Coral Pink	120cm x 170cm	1
PT561410	Coral Pink	160cm x 230cm	1
PT561540	Denim Blue	80cm x 150cm	1
PT561557	Denim Blue	120cm x 170cm	1
PT561564	Denim Blue	160cm x 230cm	1
PT562196	Warm Grey	80cm x 150cm	1
PT562202	Warm Grey	120cm x 170cm	1
PT562219	Warm Grey	160cm x 230cm	1
PT603516	Dark Green	80cm x 150cm	1
PT603523	Dark Green	120cm x 170cm	1
PT603530	Dark Green	160cm x 230cm	1
PT603547	Rust	80cm x 150cm	1
PT603554	Rust	120cm x 170cm	1
PT603561	Rust	160cm x 230cm	1

THROWS

Product No	Colour	Size	Pack
PT540552	Natural	130cm x 180cm	1
PT540705	Sky Grey	130cm x 180cm	1
PT540859	Green	130cm x 180cm	1
PT541009	Rose	130cm x 180cm	1
PT541153	Navy	130cm x 180cm	1
PT541306	Gold	130cm x 180cm	1
PT561427	Coral Pink	130cm x 180cm	1
PT561571	Denim Blue	130cm x 180cm	1
PT562226	Warm Grey	130cm x 180cm	1
PT601765	Dark Green	130cm x 180cm	1
PT601758	Rust	130cm x 180cm	1

CUSHIONS

Product No	Colour	Size	Pack
PT540569	Natural	45cm x 45cm	1
PT540712	Sky Grey	45cm x 45cm	1
PT540866	Green	45cm x 45cm	1
PT541016	Rose	45cm x 45cm	1
PT541160	Navy	45cm x 45cm	1
PT541313	Gold	45cm x 45cm	1
PT561434	Coral Pink	45cm x 45cm	1
PT561588	Denim Blue	45cm x 45cm	1
PT562233	Warm Grey	45cm x 45cm	1
PT601789	Dark Green	45cm x 45cm	1
PT601772	Rust	45cm x 45cm	1

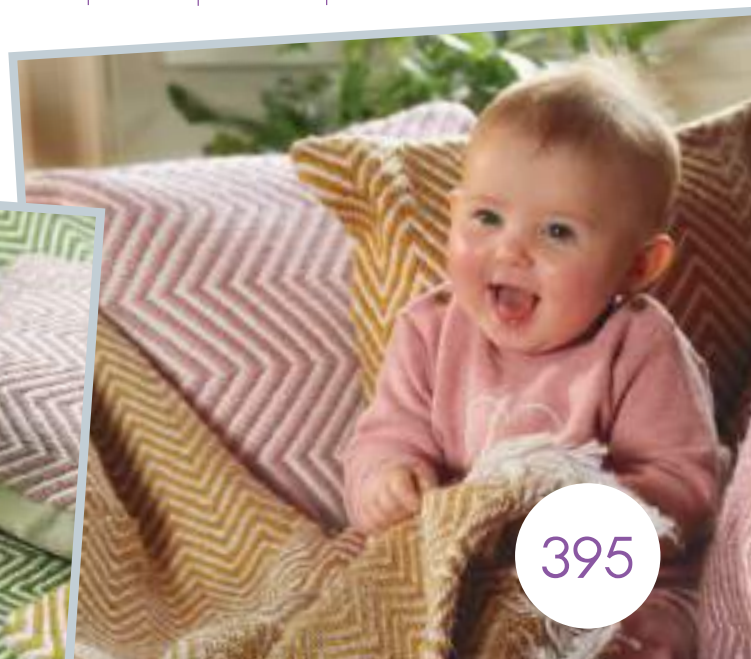



CROSS HATCH DESIGN

A great new design to add to our collection – even softer than ever and the simple design is a perfect accessory for any home.

CUDDLY THROWS...



BLACK

Product No	Colour	Size	Pack
PT619975	Black	130cm x 180cm	1
PT620001	Beige	130cm x 180cm	1
PT619982	Navy	130cm x 180cm	1
PT619999	Green	130cm x 180cm	1
PT620018	Rust	130cm x 180cm	1



BEIGE



NAVY



GREEN



RUST

COZY CUSHIONS...



BEIGE

Product No	Colour	Size	Pack
PT619951	Beige	45cm x 45cm	1
PT619920	Black	45cm x 45cm	1
PT619944	Green	45cm x 45cm	1
PT619968	Rust	45cm x 45cm	1
PT619937	Navy	45cm x 45cm	1



BLACK



GREEN



RUST



NAVY





**A BEAUTIFUL LONG PILE RUG THAT
REDUCES BACTERIAL GROWTH,
IS STAIN RESISTANT AND WASHABLE.
IDEAL FOR ANY ROOM IN THE HOME**

OUR RANGE

These stylish rugs come in a range of on trend colours and will take everything family life has to throw at them. They add a layer of warmth to wooden floors and are resistant to most water-based stains. Your customers will love them.



- 100% British design and manufacture
- Made from 100% Polypropylene frisee
- Extra hygienic – reduces bacterial growth by 70%*
- Stain resistant**
- Washable and quick dry for easy care
- Colour fast, wash-fast, light-fast and fade resistant

- Non-slip flexible rubber backing with recycled content
- Soft and comfortable, extra long pile that will never flatten
- Extra strong fibres make it long lasting with whipped edges
- No shedding, anti-static pile
- Resistant to mould, mildew and bacteria
- Suitable for any area of the home – great range of colours

STAIN RESISTANT TO...



WINE



BABY OIL (OR OTHER CLEAR OIL)



MAKE-UP (NON OIL BASED)



COFFEE



FOOD



FAKE TAN



JUICE



WASHABLE FELT PENS



WITH RUBBER BACKING AND WHIPPED EDGE



REDUCED BACTERIAL GROWTH



STAIN & MOULD RESIST



WASHABLE



NON-SLIP NON-SCRATCH



HELPS REDUCE NOISE & ECHO
Patent Pending
GB181261.9



FAST DRYING



CONTAINS RECYCLED PLASTIC IN BACKING



*Independent tests have shown that these mats reduce the growth of bacteria by 70.86%

**We can not be held responsible for any damage to flooring underneath the rug if a spill leaks through



PLAIN RUGS

Long soft pile making it extra comfy underfoot



GHOST GREY Proportion shown 80cm x 120cm

Construction:

- Tufted 100% polypropylene frisee
- Backing: rubber backing with recycled content
- Pile height: 25mm
- Edges: whipped edges

Product No	Colour	Size	Pack
PT546806	Midnight Blue	60cm x 100cm	1
PT546783	Forest Green	60cm x 100cm	1
PT546790	Ox Red	60cm x 100cm	1
PT534209	Ivory	60cm x 100cm	1
PT539570	Teal	60cm x 100cm	1
PT539556	Black	60cm x 100cm	1
PT534216	Nude Pink	60cm x 100cm	1
PT534223	Ghost Grey	60cm x 100cm	1
PT534186	Charcoal	60cm x 100cm	1
PT539594	Red	60cm x 100cm	1
PT534179	Stone	60cm x 100cm	1
PT539600	Ochre	60cm x 100cm	1
PT567009	Denim Blue	60cm x 100cm	1
PT546868	Midnight Blue	80cm x 120cm	1
PT546844	Forest Green	80cm x 120cm	1
PT546851	Ox Red	80cm x 120cm	1
PT534261	Ivory	80cm x 120cm	1
PT539792	Teal	80cm x 120cm	1
PT539778	Black	80cm x 120cm	1
PT534278	Nude Pink	80cm x 120cm	1
PT534285	Ghost Grey	80cm x 120cm	1
PT534247	Charcoal	80cm x 120cm	1
PT539815	Red	80cm x 120cm	1
PT534230	Stone	80cm x 120cm	1
PT539822	Ochre	80cm x 120cm	1
PT567030	Denim Blue	80cm x 120cm	1

COLOURS AVAILABLE:



MIDNIGHT BLUE FOREST GREEN OX RED IVORY TEAL

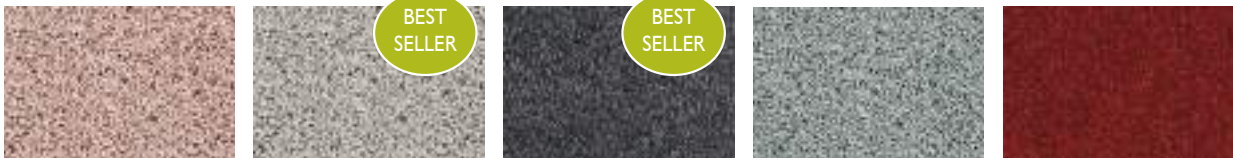

NUDE PINK GHOST GREY CHARCOAL DENIM BLUE RED



STONE OCHRE BLACK

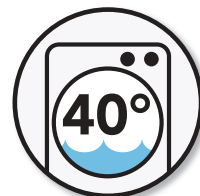



My Lux LUXURY PILE, WASHABLE RUGS

With all the same amazing benefits and stain resistance you know and love from My Rug, our My Lux range has longer pile length and thickness. These amazing washable rugs add the luxurious feel of traditional shaggy rugs yet are stain resistant and washable! Unbeatable softness underfoot and adds instant warmth to a room.



SILVER

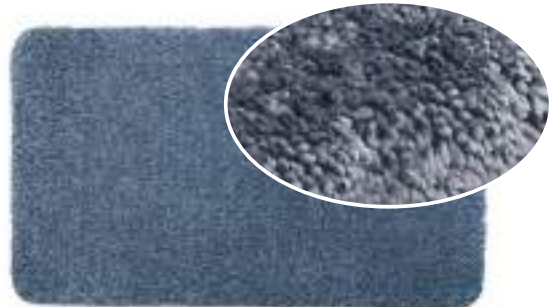

SMOKE BLUE



CHARCOAL



STONE

Construction:

Tufted 100% Polypropylene Super Soft Set

Backing: Rubber backing with recycled content

Pile height: 30mm

Edges: Whipped edges

Product No	Colour	Size	Pack
PT603165	Silver	60cm x 100cm	1
PT603196	Smoke Blue	60cm x 100cm	1
PT603226	Charcoal	60cm x 100cm	1
PT603257	Stone	60cm x 100cm	1
PT603172	Silver	80cm x 120cm	1
PT603202	Smoke Blue	80cm x 120cm	1
PT603233	Charcoal	80cm x 120cm	1
PT603264	Stone	80cm x 120cm	1
PT603189	Silver	67cm x 150cm	1
PT603219	Smoke Blue	67cm x 150cm	1
PT603240	Charcoal	67cm x 150cm	1
PT603271	Stone	67cm x 150cm	1



REDUCES BACTERIA



STAIN RESIST



WASHABLE



RECYCLED CONTENT



NOISE REDUCING



ANTI-SLIP



FAST DRYING



SUITABLE FOR UNDER FLOOR HEATING



relay.global



GARDENING 2024

Hello Friend



**SINGING
FRIEND**

Hello Sam



Made of foils from 8 beverage cartons

Eco friendly bird feeder for wild birds made from 100% recycled material from used beverage cartons. Unique in the market!



Also Twin version

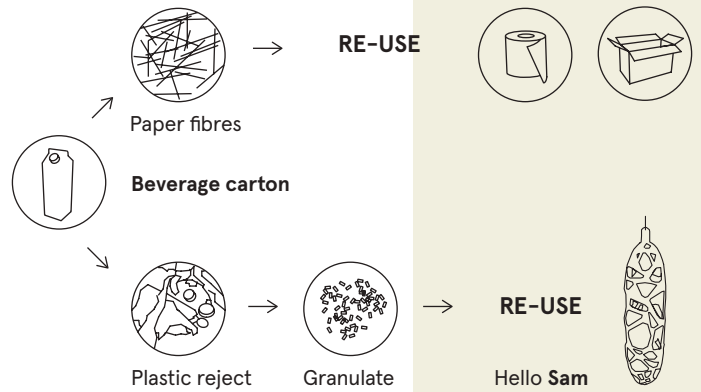

Birds



Food/Nesting material



Bird feeder

Product No	Colour	Pack
SFT002	Grey	6
SFT004	Grey Twinpack	6

Hello Anna



Made of foils from 9 beverage cartons

Eco friendly bird feeder for wild birds made from 100% recycled material from used beverage cartons. Unique in the market!



Also Window version

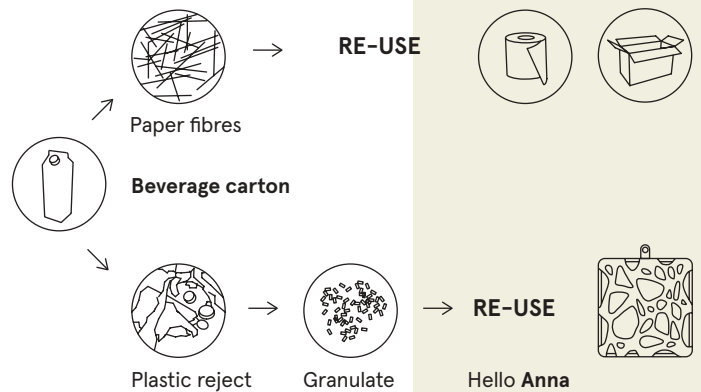

Birds



Food



Bird feeder

Product No	Colour	Type	Pack
SFA003	Grey	Hanging	6
SFA002	Grey	Window	6

Hello Yara



Made of foils from 40 beverage cartons

Eco friendly bird feeder for wild birds made from 100% recycled material from used beverage cartons. Unique in the market!

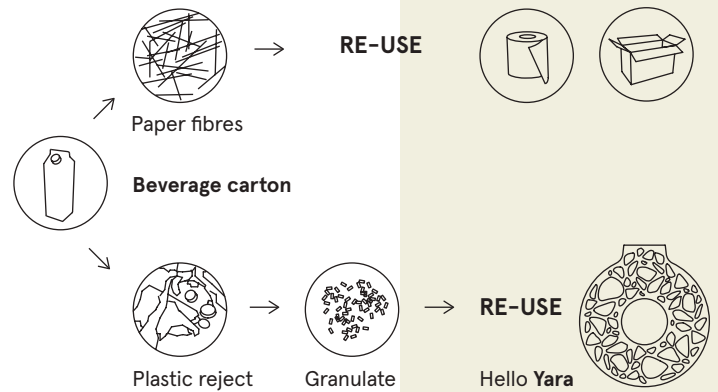

Food



Bird feeder

Product No	Colour	Pack
SFY002	Grey	4

Hello Tara



Made of foils from 28 beverage cartons

Eco friendly bird feeder for wild birds made from 100% recycled material from used beverage cartons. Unique in the market!

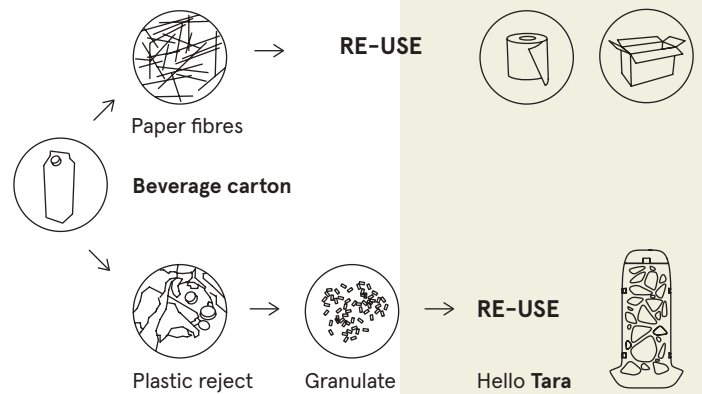

Birds



Food



* Without bottle

Bird feeder

Product No	Colour	Type	Pack
SFZ001	Grey	Feeder With Bottle	6
SFZ002	Grey	Feeder	6

Hello Esmee



Made of foils from 18 beverage cartons



Bird feeder

Eco friendly bird feeder for wild birds made from 100% recycled material from used beverage cartons. Unique in the market!

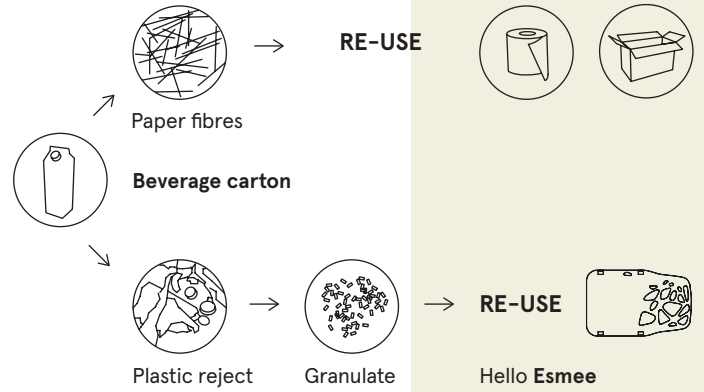

Birds



Food



Product No	Colour	Pack
SFP050	Grey	12

Hello Max



Made of foils from 18 beverage cartons



Bird feeder

Max can be quickly and easily hung up and refilled. Max is stylish and only small birds can eat from this feeder.



Product No	Colour	Pack
SFL005	Grey	6

Hello Jesse

Made of foils from beverage cartons



Bird feeder

Eco friendly bird feeder for wild birds made from 100% recycled material from used beverage cartons. Unique in the market!

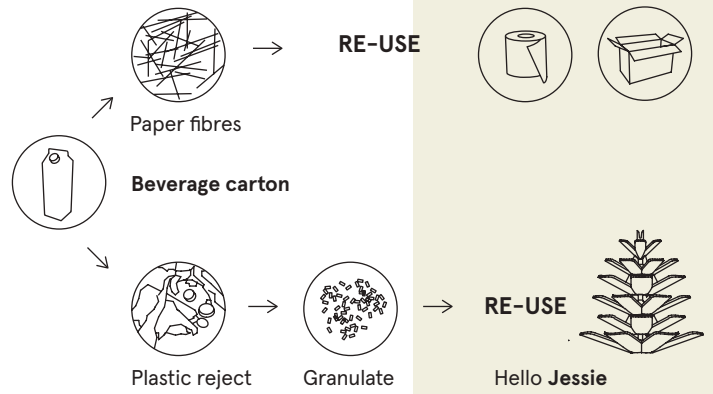

Birds



Food



Product No	Colour	Pack
SFZ100	Grey	6

Hello Evie

Made of foils from 18 beverage cartons



Bird feeder

Evie has a modern design. The garden or balcony is never boring again. Made from 100% recycled material from used beverage cartons (except the front panel).

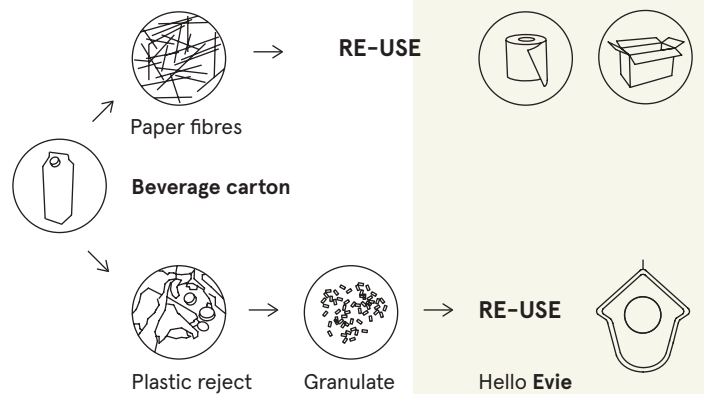

Food



Product No	Design	Pack
SFP020	Wood	6
SFP021	Leaves	6
SFP022	Flower	6

Hello Faya



Bird feeder

The combination with natural materials makes this bird feeder different and beautiful in every garden.



Birds



Food



Product No	Design	Pack
SFW001	Willow	9

Hello Nyah



Bird feeder

The combination with natural materials makes this bird feeder different and beautiful in every garden.



Birds



Food



Product No	Design	Pack
SFW002	Willow	9

Hello Dex



Bird feeder

These bird feeders are made of wire. Wire is durable in the most literal sense of the word; it lasts a long time. It can also be recycled for 95% without losing quality. Years of bird fun guaranteed!



Birds



Food



x3-7



x2

Product No	Colour	Pack
SFD001	Black	6
SFD005	Rusty Brown	6

Hello Beau



Bird feeder

These bird feeders are made of wire. Wire is durable in the most literal sense of the word; it lasts a long time. It can also be recycled for 95% without losing quality. Years of bird fun guaranteed!



Birds



Food



x3-7

Product No	Colour	Pack
SFD002	Black	6
SFD006	Rusty Brown	6

Hello Bobbie



Bird feeder

These bird feeders are made of wire. Wire is durable in the most literal sense of the word; it lasts a long time. It can also be recycled for 95% without losing quality. Years of bird fun guaranteed!



Birds



Food



x3-7



x2

Product No	Colour	Pack
SFD003	Black	6
SFD007	Rusty Brown	6

Hello Nala



Bird feeder

These bird feeders are made of wire. Wire is durable in the most literal sense of the word; it lasts a long time. It can also be recycled for 95% without losing quality. Years of bird fun guaranteed!



Birds



Food



x3-7

Product No	Colour	Pack
SFD004	Black	6
SFD008	Rusty Brown	6

Hello Lisa



Bird feeder

Lisa is handmade from durable ceramic in natural earth tones. Elegance meets functionality in this feeder.

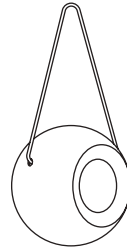

Birds



Food



Product No	Colour	Pack
SFR001	Grey	6
SFR002	Dusty Beige	6

Hello Nina



Bird nesting box

Nina is handmade from durable ceramic in natural earth tones. Elegance meets functionality in this nesting box.

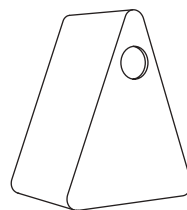

Easy to hang

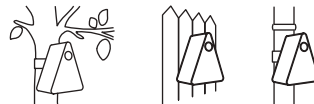

Birds



Product No	Colour	Pack
SFN001	Grey	6
SFN002	Beige	6

Hello Jan



Bird nesting box

Traditional design, designed with an eye for detail and quality. Made from pine wood.

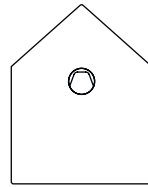

Use

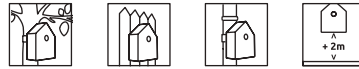

Birds



Product No	Colour	Pack
SFC002	Wood	1

Hello Saar



Bird nesting box

An eye-catcher in the garden due to its simplicity and beautiful material. Made from pine wood.

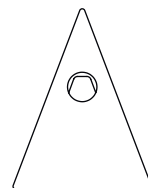

Use



Birds



Product No	Colour	Pack
SFC001	Wood	1

Hello Feedr



Bird feeder

The Feedr is a beautiful and practical bird feeder because of its clever design. Feedr keeps the food dry on rainy days.

Easy to hang



Birds



Food



Product No	Colour	Pack
SFF005	Grey	6
SFF006	Wild Green	6

Hello Multi Feedr



Bird feeder

The Multi Feedr is designed in a way so many kinds of food can be used; from bird suet balls to peanuts and sunflower seeds. The Multi Feedr = variation.

Easy to hang



Birds



Food



Product No	Colour	Pack
SFM003	Grey & White	6
SFM004	Wild Green & White	6

Hello Breedr



Bird nesting box

The Breedr is flexible in its use because of the different sizes of entrances. Choose which type of birds you want to breed in this nest box.

Easy to hang



Birds



28 mm



35 mm



40 mm



Product No	Colour	Pack
SFB005	Grey	6

Hello Wild bird food



Bird peanut butter

Manufactured using human grade ingredients. High bird acceptance with wild birds.

For use with Esmee bird feeder and Evie bird feeder.

Feeders



Hello Evie



Hello Esmee

Birds



Product No	Type	Pack
SFPP001	Bird Peanut Butter 350g	10

Hello Displays



Interested? Contact us for options.

Hello Friend,

Our story starts in 1951, with a man and his deep-rooted passion for birds. A strong foundation. The family business was passed from father to son, and then the third generation took over. The love for birds remained.

These days, we add to the enjoyment of gardens, balconies and terraces. For people and for animals. With our close team, we are continuously working on new concepts, looking for the connection between humans, nature and good products. While we do this, we are kind to the earth, for example by using sustainable and environmentally friendly resources. And the price, we keep that kind as well.

Singing Friend stands for a mix of (multi) functionality, ease of use and quality, with an attention to detail in all aspects. All of our products are made for the convenience of our clients, for people's enjoyment of their homes and for the happiness of our singing friends. We build a bridge between design and nature, and stimulate the creation of new living environments for birds, by people.

That is our passion.

The Singing Friend formula

Attention

In everything we do, we pay just that little bit of extra attention.

Attention to detail, attention to (multi) functionality and attention to the high quality finish of our unique products. Most importantly, we pay attention to our customers. We are reliable, service-minded and always looking for long-term partnerships. Because attention has the most beautiful results, guarantees high quality and provides the best effects in the long-term.

+

Sustainability

Mother nature is our greatest gift. This respect for nature is in our DNA, and it shows in our products. There is a reason why sustainability is one of our most important values. We strive for fairness in the broadest sense of the word; from the use of sustainable resources to making our products and our selected manufacturers, to fair prices.

+

Uniqueness

'Different' is one of our characteristics. The products in our range and our designs are unique. We develop products that fit the latest trends, and are also timeless when it comes to the selection of materials and functionality. Collaboration is what defines us. We believe that is important to let every person reinforce the team with their own strengths. Together, practical, beautiful and above all unique.



Rustic Bowl Planter

Rustic Round Planter

Rustic Gawsworth Planter

Product No	Colour	Size	Pack
GA400977	Black & Silver	30cm	24
GA400960	Black & Bronze	30cm	24



Product No	Colour	Size	Pack
GA400892	Black & Silver	30cm	24
GA401127	Black & Bronze	30cm	24

Product No	Colour	Size	Pack
GA406528	Black & Silver	30cm	24
GA406535	Black & Bronze	30cm	24

Rustic Vintage Planter

Rustic Shrigley Planter

Rustic Antiqua Round Planter

Product No	Colour	Size	Pack
GA406542	Black & Silver	33cm	24
GA406559	Black & Bronze	33cm	24



**BEST
SELLER**

Product No	Colour	Size	Pack
GA401028	Black & Bronze	45cm	24

Product No	Colour	Size	Pack
GA400984	Black & Bronze	35cm	24
GA401004	Black & Bronze	45cm	24

Rustic Trough Planter

Rustic Square Planter

Product No	Colour	Size	Pack
GA400908	Black & Bronze	27cm	24
GA400922	Black & Bronze	32cm	24
GA400915	Black & Silver	27cm	24
GA400939	Black & Silver	32cm	24



Product No	Colour	Size	Pack
GA400946	Black & Bronze	60cm	24
GA400953	Black & Silver	60cm	24
GA401110	Black	60cm	24



Whatever your outdoor style...
Gardag has the answer!

Gracia Beton Effect Planter

- Made of 100% recycled material
- The design includes a water reservoir
- Adds a modern, stylish look to outdoor spaces
- Durable recycled plastic construction can withstand all weather conditions and will stay looking great for years
- Its lightweight design makes it easy to move in the garden or patio



Product No	Colour	Size	Pack
DGRL350E-S433	Anthracite	339mm	5
DGRL350E-422U	Concrete	339mm	5

Gracia Case Beton Effect Planter

- Made of 100% recycled material
- The design includes a water reservoir
- Adds a modern, stylish look to outdoor spaces
- Durable recycled plastic construction can withstand all weather conditions and will stay looking great for years
- Its lightweight design makes it easy to move in the garden or patio



Product No	Colour	Size	Pack
DGCL600E-S433	Anthracite	580mm	5
DGCL600E-422U	Concrete	580mm	5

Tube P Beton Effect Planter

- Made of 100% recycled material
- Adds a modern, stylish look to outdoor spaces
- Durable recycled plastic construction can withstand all weather conditions and will stay looking great for years
- Its lightweight design makes it easy to move in the garden or patio



Product No	Colour	Size	Pack
DPOP200E-S433	Anthracite	199mm	10
DPOP200E-422U	Concrete	199mm	10
DPOP350E-S433	Anthracite	338mm	5
DPOP350E-422U	Concrete	338mm	5

Tubus Beton Effect Planter

- Made of 100% recycled material
- Adds a modern, stylish look to outdoor spaces
- Durable recycled plastic construction can withstand all weather conditions and will stay looking great for years
- Its lightweight design makes it easy to move in the garden or patio



Product No	Colour	Size	Pack
DTUB400E-S433	Anthracite	400mm	10
DTUB400E-422U	Concrete	400mm	10

Urbi Square Beton Effect Planter

- Made of 100% recycled material
- Adds a modern, stylish look to outdoor spaces
- Durable recycled plastic construction can withstand all weather conditions and will stay looking great for years
- Its lightweight design makes it easy to move in the garden or patio



Product No	Colour	Size	Pack
DURS200E-S433	Anthracite	195mm	5
DURS200E-422U	Concrete	195mm	5
DURS265E-S433	Anthracite	265mm	5
DURS265E-422U	Concrete	265mm	5
DURS400E-S433	Anthracite	400mm	3
DURS400E-422U	Concrete	400mm	3

Urbi Case Beton Effect Planter

- Made of 100% recycled material
- Adds a modern, stylish look to outdoor spaces
- Durable recycled plastic construction can withstand all weather conditions and will stay looking great for years
- Its lightweight design makes it easy to move in the garden or patio



Product No	Colour	Size	Pack
DUC600E-S433	Anthracite	580mm	5
DUC600E-422U	Concrete	580mm	5

Load & Go Garden Caddy

- Helps save time and effort with easy maneuverability
- Sturdy design for convenient transporting of garden items
- Robust construction ensures that it will withstand the elements



Product No	Colour	Pack
IWO55Z-370U	Green	1
IWO55C-S411	Black	1

Compogreen Composter

- Provides a simple and sustainable option for composting household and garden waste
- Made of high quality plastic that is durable and resistant to damage or fading, ensuring lasting use
- The innovative design has air openings which allow air to circulate and promote aeration for faster decomposition
- Easily transportable and conveniently collapsible for easy storage when not in use



Product No	Size	Pack
IKST220C-S411	220L	1
IKST320C-S411	320L	1

Waterform Smooth Water Butt

- Provides a generous capacity of 200L
- The robust construction ensures long lasting performance with no need for maintenance or repair
- With its contemporary design, it looks great in any garden or outdoor space



Product No	Size	Pack
IDSM200-S433	200L	1

Waterform Peruno Water Butt

- Provides a generous capacity of 260L
- The robust construction ensures long lasting performance with no need for maintenance or repair
- With its contemporary design, it looks great in any garden or outdoor space



Product No	Size	Pack
IDPE260-S433	260L	1

Waterform Basecan Water Butt Base



Product No	Size	Pack
IBAS2-S433	608mm	1

Waterform Water Butt Full Filter Connection Set

Product No	Pack
ICANS7	15

- Provides all the connections required for rainwater harvesting with a water butt

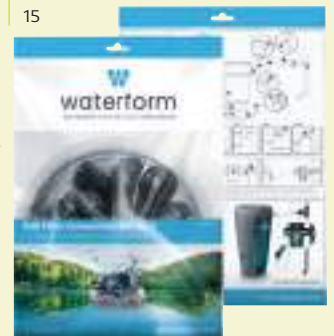

Spring Watering Can

- Designed with an ergonomic handle for easy and comfortable use
- Its angled spout provides a strong and even water flow, making watering easier
- Available in a selection of sizes to suit every garden
- The robust plastic design ensures durability for long lasting use



Product No	Size	Pack
IKSP03-G642	3L	15
IKSP05-G642	5L	10
IKSP08-G642	8L	10
IKSP10-G642	10L	8
IKSP14-G642	14L	6

Go Bag

- Great for carrying, tidying and storing in the garden, around the home and at the stable yard
- Made from heavy duty laminated woven polypropylene
- Stands upright for easy filling
- Will withstand rough treatment and will not tear if dragged
- With carrying handles and tipping strap on base
- Convenient size allows it to fit in a car
- Folds to a small size so it can be stored easily
- Perfect for construction sites and DIY jobs



Product No	Pack
GBPBCDU8	8

Uniqubo Set

- Uniqubo is a set of multi-functional outdoor furniture which provides flexibility for everyday use
- The openwork seats and the table with a top made of natural material perform well in the recreational garden space, on the terrace or balcony, or in the home relaxation zone
- Made of a lightweight yet durable material
- Easy to clean
- Weatherproof



Product No	Colour	Pack
IKUBS3-S433	Anthracite	1



GARDEN TOOLS ENERGO™

Close cooperation between technologists and designers in the creation of tools resulted in a line of products refined in every detail, which combine functionality and ergonomics. There is no doubt that these are tools for demanding customers. Innovative solutions, top-quality materials, great design and an exceptional emphasis on ergonomics are the hallmarks of the tools manufactured by Cellfast.

Garden Lawn Edging

- Made of waterproof flexible material
- Prevents grass from overgrowing into flowerbeds and paths
- Perfectly separates lawn from cultivated part and flower beds
- It is recommended to install lawn edge at ground level



Product No	Colour	Size	Pack
30-001H	Green	10cm x 9m	12
30-002H	Green	15cm x 9m	12
30-003H	Green	20cm x 9m	12
30-011H	Brown	10cm x 9m	12
30-012H	Brown	15cm x 9m	12
30-013H	Brown	20cm x 9m	12

Eco Garden Palisade

- Perfectly separates lawn from cultivated part and flower beds
- Innovative spike construction prevents it from breaking during installation
- Wood texture on the surface of the palisade
- No maintenance required
- UV resistant - colour fastness
- Frost resistant
- Convenient way of connecting elements allows for the formation of multiple shapes
- Size: 17cm x 2.4m



Product No	Colour	Pack
34-031	Brown	1
34-054	Graphite	1

Simple Garden Lawn Edging

- Made of waterproof flexible material
- Prevents grass from overgrowing into flowerbeds and paths
- Perfectly separates lawn from cultivated part and flower beds
- It is recommended to install lawn edge at ground level



Product No	Colour	Size	Pack
30-211H	Brown	10cm x 9m	12
30-212H	Brown	15cm x 9m	12
30-213H	Brown	20cm x 9m	12



Premium Cutting Elements

- Contains aluminium for added strength
- Available in three line shapes: round, square, and star in popular line lengths
- The diameter of the cutting elements depends on the type of the trimmer



Round

Product No	Size	Pack
35-032	2.0mm x 15m	10
35-033	2.4mm x 15m	10
35-035	2.7mm x 15m	10
35-036	3.0mm x 15m	10
35-037	2.4mm x 90m	5
35-038	2.7mm x 90m	5
35-039	3.0mm x 80m	5

Square

Product No	Size	Pack
35-042	2.0mm x 15m	10
35-043	2.4mm x 15m	10
35-045	2.7mm x 15m	10
35-046	3.0mm x 15m	10
35-047	2.4mm x 70m	5
35-048	2.7mm x 60m	5
35-049	3.0mm x 55m	5

Star

Product No	Size	Pack
35-052	2.0mm x 15m	10
35-053	2.4mm x 15m	10
35-055	2.7mm x 15m	10
35-056	3.0mm x 15m	10
35-057	2.4mm x 90m	5
35-058	2.7mm x 90m	5
35-059	3.0mm x 80m	5

Cutting Elements

- Available in six diameters
- Three line shapes: round, square, star
- Diameter of the cutting elements depends on the type of the trimmer



Round

Product No	Size	Pack
35-001	1.3mm x 15m	10
35-002	1.6mm x 15m	10
35-003	2.0mm x 15m	10
35-004	2.4mm x 15m	10
35-006	2.7mm x 15m	10
35-005	3.0mm x 15m	10
35-007	3.0mm x 90m	5

Square

Product No	Size	Pack
35-010	1.3mm x 15m	10
35-011	1.6mm x 15m	10
35-012	2.0mm x 15m	10
35-013	2.4mm x 15m	10
35-016	2.7mm x 15m	10
35-014	3.0mm x 15m	10

Star

Product No	Size	Pack
35-021	2.4mm x 15m	10
35-026	2.7mm x 15m	10
35-022	3.0mm x 15m	10

Ergo Straight Spade

- Designed for work in hard soil, it allows easy and safe digging, planting and burrowing
- Ergonomic handle ensures a correct, stable posture during work and minimizes muscle tension
- The shape of the handle provides a sure and comfortable grip
- The Safetouch™ system provides a secure grip and comfort, as well as protection against accidental damage
- Soft, non-slip surface provides a comfortable hold of the tool with both hands
- Induction-hardened head of high-quality boron steel reinforced with pressing
- The head of the spade is equipped with an integral, durable metal stand for the foot, providing support while driving the spade into the ground
- Length 1230mm, weight 2.1kg

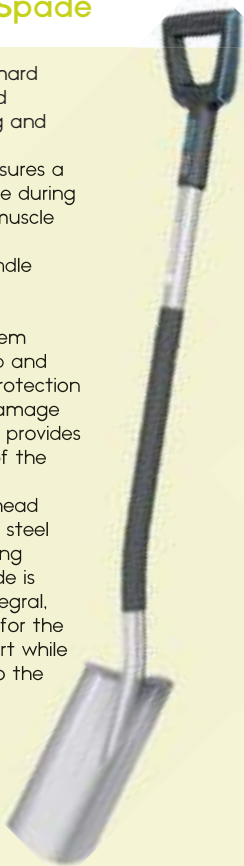

Product No	Pack
40-001	3

Ergo Pointed Spade

- Designed for work in hard soil, it allows easy and safe digging, planting, burrowing and removal of roots
- Ergonomic handle ensures a correct, stable posture while working, and minimizes muscle tension
- The shape of the handle provides a sure and comfortable grip
- The Safetouch™ system provides a secure grip and comfort, as well as protection against accidental damage
- Soft, non-slip surface provides a comfortable hold of the tool with both hands
- Induction-hardened head with high-quality boron steel reinforced with pressing
- The head of the spade is equipped with an integral, durable metal stand for the foot, providing support while driving the spade into the ground
- Length 1230mm, weight 2.1kg

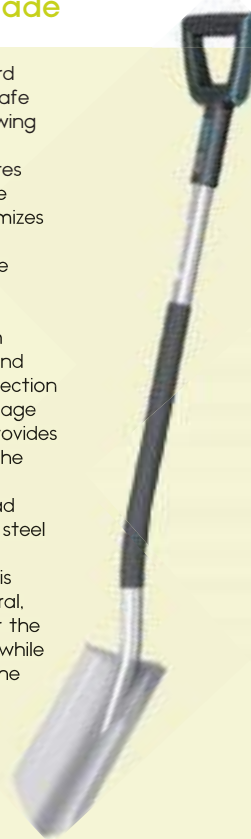

Product No	Pack
40-002	3

Ergo Shovel

- Used for scooping and pouring bulk loose materials, sand, gravel, and earth
- Ergonomic handle ensures a correct, stable posture while working, and minimizes muscle tension
- The shape of the handle provides a sure and comfortable grip
- The Safetouch™ system provides a secure grip and comfort, as well as protection against accidental damage
- Soft, non-slip surface provides a comfortable hold of the tool with both hands
- Induction hardened head with high-quality boron steel reinforced with pressing
- Length 1300mm, weight 2.2kg

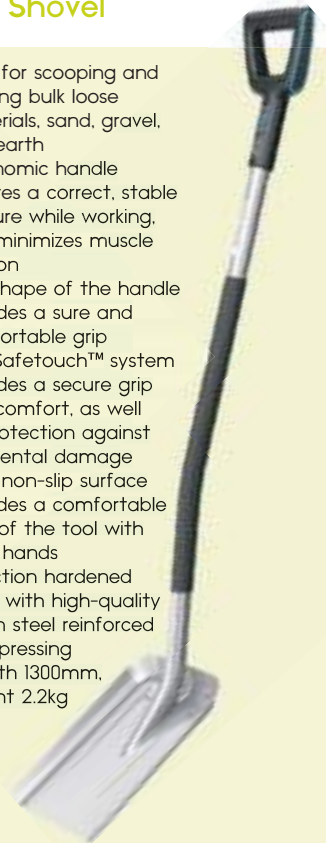

Product No	Pack
40-010	3

Ergo Digging Fork

- Used for digging and softening the soil
- Ergonomic handle ensures a correct, stable posture while working, and minimizes muscle tension
- The shape of the handle provides a sure and comfortable grip
- The Safetouch™ system provides a secure grip and comfort, as well as protection against accidental damage
- Soft, non-slip surface provides a comfortable hold of the tool with both hands
- Hardened teeth made of high quality boron steel
- Length 1230mm, weight 2.1kg

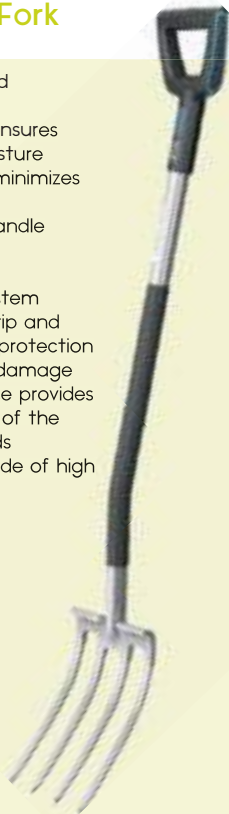

Product No	Pack
40-020	3

Ergo Hoe

- Perfect for digging, weeding and softening soil
- Durable, hardened head made of steel which is sharpened on three sides
- Shorter side facilitates planting
- Upper part of the head enables breaking up clods of soil
- Rounded edges prevent the blade from bending
- Lightweight aluminum shaft
- Safetouch™ system provides a secure grip and comfort, as well as protection against accidental damage
- Hanging hole enables easy storage
- Working width 170mm
- Length 1525mm, weight 0.7kg



Product No	Pack
40-030	3

Ergo Cultivator

- Used for aeration and softening soil
- Helps to remove weeds with shallow roots and prepare flowerbeds for sowing seeds
- Durable and hardened steel teeth
- Lightweight aluminum shaft
- Safetouch™ system provides a secure grip and comfort, as well as protection against accidental damage
- Hanging hole enables easy storage
- Working width 100mm
- Length 1640mm, weight 0.8kg



Product No	Pack
40-040	3

Ergo Universal Metal Rake

- Ideal for leveling, breaking up clods of earth and raking grass
- Hardened, durable boron steel head
- Aluminum, lightweight, simple handle of high strength
- Safetouch™ system provides a secure grip and comfort, as well as protection against accidental damage
- Hanging hole enables easy storage
- Working width 370mm, 14 teeth
- Length 1520mm, weight 0.9kg



Product No	Size	Pack
40-100	370mm	3

Ergo Leaf Rake

- For raking leaves, grass and other garden waste
- Aluminum, lightweight, simple handle of high strength
- Safetouch™ system provides a secure grip and comfort, as well as protection against accidental damage
- Universal adapter allows for quick replacement of the heads, providing a very secure and stable connection
- Flexible, replaceable head made of durable plastic
- Unique shape, reduces clogging of the teeth, provides smooth, efficient and comfortable work
- Hanging hole enables easy storage
- Spare rake heads available



Product No	Type	Pack
40-110	430mm Rake	5
40-111	525mm Rake	5
40-120	430mm Head	5
40-121	525mm Head	5

Ergo Pruning Saw

- Ergonomic pruning saw with blade made of high quality steel designed for cutting fresh, dry branches and shoots
- Works also as a survival tool during camps and bivouacs
- The concave blade cross-section prevents saw blocking while cutting and increases resistance to bending and breaking
- Aggressively hardened teeth with 3 ground cutting edges allow for secure and quick cutting as well as preventing clogging
- Safetouch™ handle surface provides secure grip and comfort in use
- Enclosed holster applied to the belt allows for safe carrying and storage of the saw
- Length of blade is 300mm/12"



Product No	Pack
41-040	5

Ergo General-Purpose Scissors

- Perfect for work at home, in the office, at school, or for the sewing room
- Blades made of high-quality, durable stainless steel guarantee precise cutting
- Profiled handles with a secure grip coating fit perfectly in the hand, providing comfort in use
- Overall length 235mm



Product No	Size	Pack
42-070	23cm	6

Ergo Multi-Purpose Scissors

- Blade includes a bottle opener/nutcracker
- Hardened blade, made of stainless steel
- Serrated blade makes cutting easier and more controlled
- Ergonomic shape of the handles provides comfort and convenience during use
- Supplied with a guard to protect the blades



Product No	Size	Pack
42-071	22cm	6

Ergo Garden Care Tools Set

- This set includes a selection of Ergo garden care tools, including a Narrow Trowel, Cultivator and Gardening & Soil Gloves



Product No	Pack
42-103	3

Ergo Narrow Trowel

- For planting small, potted and rebate plants
- Easy and convenient excavation and earthmoving
- Safetouch™ system provides a secure grip and comfort, as well as protection against accidental damage
- Ergonomically shaped handle with support under the thumb provides exceptional comfort
- Blade made of high quality stainless steel
- Hanging hole enables easy storage



Product No	Pack
42-002	5

Ergo Wide Trowel

- For planting small, potted and rebate plants
- Easy and convenient excavation and earthmoving
- Safetouch™ system provides a secure grip and comfort, as well as protection against accidental damage
- Ergonomically shaped handle with support under the thumb provides exceptional comfort
- Blade made of high quality stainless steel
- Hanging hole enables easy storage



Product No	Pack
42-001	5

Ergo Dibber

- Designed for easy planting of seeds, bulbs and delicate seedlings
- The handle fits perfectly in the hand
- Functional, durable, easy to use



Product No	Pack
42-006	5

Ergo Cultivator

- For aeration and softening soil
- Facilitates aerifying of soil, helps to remove weeds with shallow roots and prepare flowerbeds for sowing seeds
- Safetouch™ system provides a secure grip and comfort, as well as protection against accidental damage
- Ergonomically shaped handle with support under the thumb provides exceptional comfort
- Teeth made of high-quality stainless steel with smooth edges safe for plants
- Hanging hole enables easy storage



Product No	Pack
42-004	5

Ergo Hand Fork

- For softening, planting and weeding
- Safetouch™ system provides a secure grip and comfort, as well as protection against accidental damage
- Ergonomically shaped handle with support under the thumb provides exceptional comfort
- Teeth of high-quality stainless steel with smooth edges which are safe for plants
- Hanging hole enables easy storage



Product No	Pack
42-003	5

Ergo Hand Rake

- For raking, softening, leveling small areas of ground
- Safetouch™ system provides a secure grip and comfort, as well as protection against accidental damage
- Ergonomically shaped handle with support under the thumb provides exceptional comfort
- Teeth made of high-quality stainless steel with smooth edges safe for plants
- Hanging hole enables easy storage



Product No	Pack
42-005	5

Ergo Chopper Splitting Axe



- Blade made of high quality induction-hardened steel, extremely durable, deeply welded with the handle
- Appropriately shaped handle made of a fiberglass-reinforced composite, provides cushioning at impact
- Soft, non-slip Safetouch™ surface, covering a substantial length of the handle provides a sure grip and comfort of use
- Multifunctional cover guarantees safe handling, storage of the axe and the sharpener
- 25-year warranty on the product upon website registration

Product No	Size	Pack
41-004	450mm	2
41-005	615mm	2
41-007	740mm	2
41-008	930mm	2

Ergo Universal Axe

- Blade made of high quality induction-hardened steel, extremely durable, deeply welded with the handle
- Appropriately shaped handle made of a fiberglass-reinforced composite, provides cushioning at impact
- Soft, non-slip Safetouch™ surface, covering a substantial length of the handle provides a sure grip and comfort of use
- Perfect balance of the tool provides high ergonomics and comfort
- Multifunctional cover guarantees safe handling, storage of the axe and sharpener
- 25-year warranty on the product upon website registration



Product No	Size	Pack
41-001	260mm	2
41-002	450mm	2
41-003	615mm	2

Ergo Universal Sharpener

- For sharpening axes, knives etc.
- Made of durable, impact-resistant polycarbonate
- Ergonomic design offers a secure, convenient and safe grip of the sharpener
- A base with rubberized feet ensures stability of the sharpener during sharpening
- A sharpening wheel made from a specially selected blend of silicon, a material for highly demanding applications



Product No	Pack
41-100	5

Ergo Tool Gloves

- Durable gloves designed for heavy garden work
- Outer made of flexible polyester with synthetic leather additional finger protection
- Reinforcement of thumb and inner part of gloves provides a secure grip and cushioning
- Cuff with Velcro fastening
- Complies with requirements of EN 388 (3 1 4 2)



Product No	Size	Pack
92-012	8/M	5
92-013	9/L	5
92-014	10/XL	5

Ergo Gardening & Soil Gloves

- Lightweight gloves for garden care work
- Made of flexible and breathable quick-drying polyester
- Covered with latex foam which provides a secure grip and comfort, as well as protecting against moisture and dirt
- Complies with requirements of EN 388 (3 1 3 1)



Product No	Size	Pack
92-002	8/M	12

Ideal Pro Straight Spade

- Designed for working in hard soil
- Allows easy and safe digging, planting, burrowing and root removal
- With an induction-hardened, sharpened head made of resilient boron steel reinforced with pressing, robust and durable handle of fiberglass composite, and durable oval grip
- The spade head is equipped with an integral durable metal stand for the foot, providing support while driving the spade into the ground
- The ergonomic shaft is covered with a durable non-slip surface
- Length 1195mm, weight 1.9kg

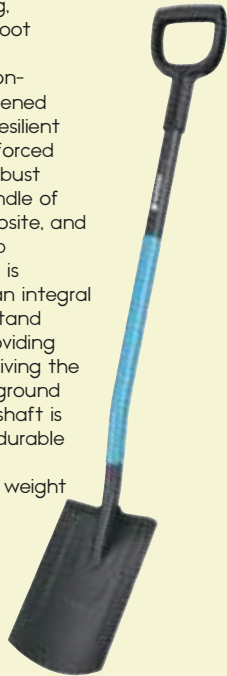

Product No	Pack
40-203	3

Ideal Pro Pointed Spade

- Designed for working in hard soil
- Allows easy and safe digging, planting, burrowing and root removal
- With an induction-hardened, sharpened head made of resilient boron steel reinforced with pressing, robust and durable handle of fiberglass composite, and durable oval grip
- The spade head is equipped with an integral durable metal stand for the foot, providing support while driving the spade into the ground
- The ergonomic shaft is covered with a durable non-slip surface
- Length 1195mm, weight 1.9kg

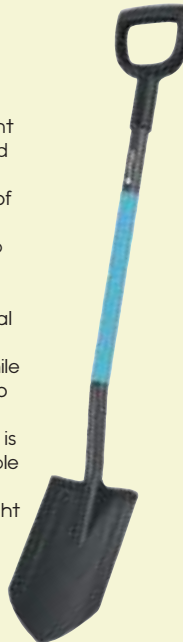

Product No	Pack
40-204	3

Ideal Pro Short Spade

- Designed for working in hard soil
- Allows easy and safe digging, planting, burrowing and root removal
- With an induction-hardened, sharpened head made of resilient boron steel reinforced with pressing, robust and durable handle of fiberglass composite, and durable oval grip
- The spade head is equipped with an integral durable metal stand for the foot, providing support while driving the spade into the ground
- The ergonomic shaft is covered with a durable non-slip surface
- Length 780mm, weight 1.5kg



Product No	Pack
40-206	3

Ideal Pro Shovel

- Used for scooping, pouring bulk loose materials such as sand, gravel and soil
- The ergonomic shaft ensures a correct, stable posture while working and minimizes muscle tension
- The shape of the handle provides a sure and comfortable grip
- The robust and durable handle is made from fiberglass composite
- The induction hardened head is made from high-quality boron steel reinforced with pressing
- Length 1300mm, weight 2.1kg

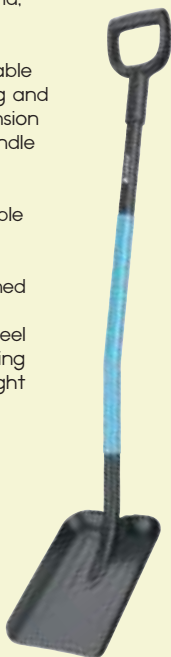

Product No	Pack
40-209	3

Ideal Pro Sand Shovel

- Used for scooping and pouring bulk loose materials such as sand
- The robust and durable handle is made from fiberglass composite
- The ergonomic shaft is covered with a durable non-slip surface
- Length 1270mm, weight 2.1kg



Product No	Pack
40-207	3

Ideal Pro Cultivator

- Use for aeration, softening soil, and helps to remove weeds with shallow roots and prepare flowerbeds for sowing seeds
- Durable and hardened teeth made of steel
- With a lightweight aluminum shaft
- A hole for hanging enables easy storage
- Working width 115mm
- Length 1600mm, weight 0.7kg



Product No	Pack
40-240	3

Ideal Pro Digging Fork

- Used for digging and softening soil
- The ergonomic shaft ensures a correct, stable posture while working and minimizes muscle tension
- The shape of the handle provides a sure and comfortable grip
- The robust and durable handle is made from fiberglass composite
- The hardened teeth are made of high quality boron steel
- Length 1200mm, weight 1.9kg



Product No	Pack
40-222	3

Ideal Pro Farm Digging Fork

- Used for loosening and spreading compost, hay and straw
- The ergonomic shaft ensures a correct, stable posture while working and minimizes muscle tension
- The shape of the handle provides a sure and comfortable grip
- The robust and durable handle is made from fiberglass composite
- The hardened teeth are made of high quality steel
- Length 1280mm, weight 1.7kg



Product No	Pack
40-223	3

Ideal Pro Pitch Fork

- Used for tossing hay or straw
- Glass fibre composite D-shaped handle for a secure and comfortable grip
- High-quality hardened steel tines, with high level of hardness, resistant to damage
- Ergonomic shaft guarantees a correct, stable working posture and minimises muscle tension
- Length 1300mm, weight 1.5kg



Product No	Pack
40-224	3

Ideal Pro Hoe

- Perfect for digging, weeding and softening the soil
- Durable, hardened head made of steel
- The shorter side facilitates planting
- With a lightweight aluminium shaft
- A hole for hanging enables easy storage
- Working width 175mm
- Length 1580mm, weight 0.6kg

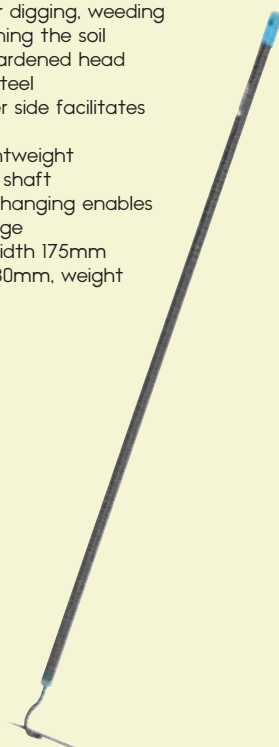

Product No	Pack
40-230	3

Ideal Pro Draw Hoe

- Designed for weeding and clearing the grounds quickly and conveniently
- Resistant stainless steel head
- High-strength, lightweight aluminium handle with non-slip surface
- Hanging hole for easy storage
- Working width 160mm
- Length 1590mm, weight 0.8kg



Product No	Pack
42-220	3

Ideal Pro Lawn Edger

- Designed for cutting lawn edges
- Helpful for creating and separating lawn and flower beds
- Hardened semicircular head made of boron steel
- Profiled blade cuts soil easily and precisely
- Lightweight, high-strength aluminium handle with non-slip surface
- Length 1330mm, weight 0.8kg



Product No	Pack
42-216	3

Ideal Pro Universal Metal Rake

- Used for leveling soil, breaking up clods of earth and raking grass
- With a hardened, durable boron steel head
- Lightweight aluminum shaft
- Safetouch™ system provides a secure grip and comfort, as well as protection against accidental damage
- Hanging hole enables easy storage
- Working width 370mm
- Length 1550mm, weight 0.9kg



Product No	Pack
40-208	3

Ideal Pro Fan Rake

- Used for raking leaves, grass and other garden waste over large areas
- Non-slip shaft surface guarantees a secure grip and protects hands from abrasion
- Flexible tines with a unique shape that limits their clogging and reduces the risk of breaking
- Large working width of the head makes it easier to work efficiently and effectively
- Lightweight aluminium handle for a comfortable working position
- Working width 650mm
- Height 2010mm, weight 1.0kg

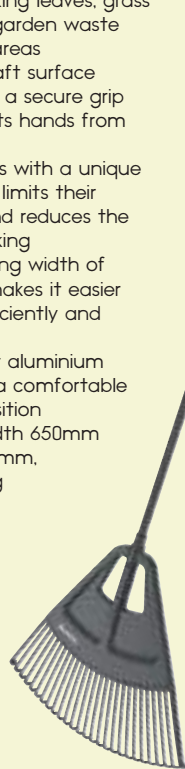

Product No	Pack
40-313	3

Ideal Pro Broom

- Designed for sweeping paths, stairs, driveways, etc
- Ideal for cleaning large surfaces
- It removes dirt, collects sand, helps scrub stains quickly
- Two thicknesses of flexible bristles thoroughly remove dirt without scratching delicate surfaces
- Width: 365mm
- Length 1760mm, weight 0.9kg



Product No	Pack
40-330	3

Ideal Weed Puller

- Allows easy weed removal without using chemicals
- Deep-reaching stainless steel claws grip the root from four sides, removing the plant along with the long root
- Ergonomic D-shaped handle provides comfort while the foot pad makes it easier to drive in to the ground
- With a convenient and easy system for adjusting the handle length from 990mm to 1190mm



Product No	Pack
42-202	2

Ideal Bulb Planter

- Plants bulbs with ease
- Spring-load action
- Ergonomic handle
- Made from chrome plated steel



Product No	Pack
40-261	3

Ideal Universal Garden Spreader

- Simple self-assembly
- Easy to empty and maintain
- Variable settings for flexibility
- For an even spread of seeds and fertilizers



Product No	Pack
42-205	1

Ideal General-Purpose Scissors

- Multi-purpose scissors for cutting a variety of materials
- Blades made of high-quality, durable stainless steel guarantee precise cutting
- Comfortable and secure grip thanks to ergonomically shaped handles made of high-quality plastic
- High durability, easy cleaning
- Overall length 210mm



Product No	Pack
40-430	6

Ideal Garden Scissors

- For pruning and shaping small plants, flowers, herbs, potted plants, also helpful when picking fruit
- Precise cutting in hard-to-reach places
- Blade made of stainless steel
- Non-slip handle
- Includes safety lock
- Length 165mm, blade thickness 2.5mm
- Maximum cutting diameter 5mm



Product No	Pack
40-431	5

Ideal Grass Shears

- Universal, one-handed grass shears designed for cutting lawn edges
- Head adjustment in the range of 360° allows to reach distant places and cut at any angle
- The base of the grass shears allows to maintain a constant cutting height
- Safetouch™ system provides secure grip and comfort in use
- Opening lock
- Blade length of 13cm and coated with non-stick surface

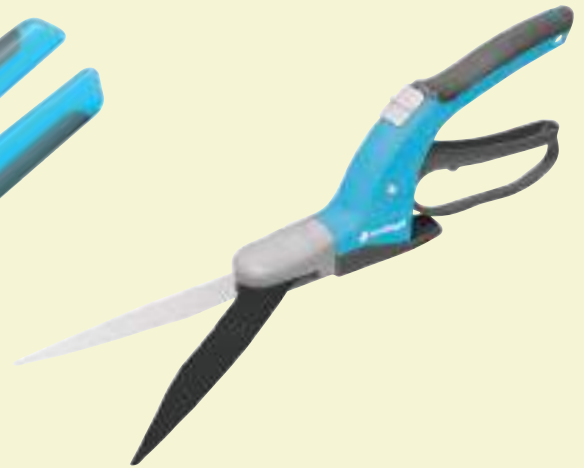

Product No	Pack
40-405	3

Ideal Pruner

- Universal, one-handed pruner designed for cutting branches and shoots
- Maximum cutting diameter 16mm
- Handles covered with Safetouch™ surface providing secure grip and comfort in use
- Opening lock
- Blade coated with non-stick surface
- Spring made of stainless steel



Product No	Type	Pack
40-414	Bypass Pruner	5
40-415	Anvil Pruner	5

Ideal Metal Pruner

- One-hand pruner for cutting branches and shoots
- Maximum cutting diameter 22mm
- Hard, chrome-plated blade made of high-carbon steel and aluminium, which makes the pruner extremely strong and sharp
- Profiled vinyl-coated handle for a solid and comfortable grip



Product No	Type	Pack
40-417	Bypass Pruner	5
40-418	Anvil Pruner	5

Ideal Garden Shears

- Two-handed shears designed for cutting bushes, small trees and hedges
- Applied gear increases cutting force
- Non-slip Safetouch™ surface provides secure grip and comfort of use
- Light, durable handles made of aluminium
- Blade length of 20cm coated with non-stick surface
- Available with standard or telescopic handles
- Telescopic option allows for easy and quick extension of the handle by an additional 18cm

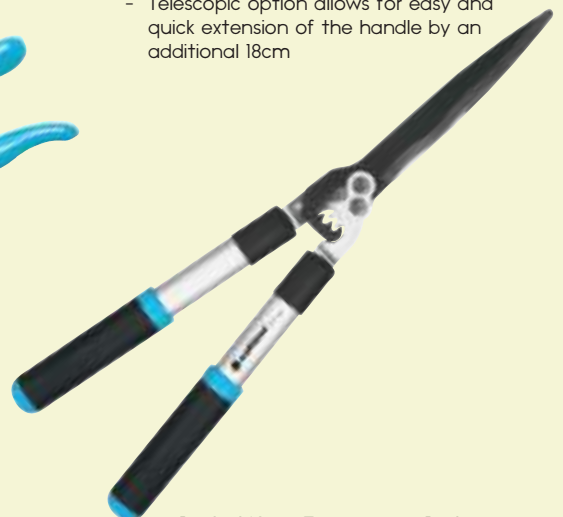

Product No	Type	Pack
40-401	Standard	3
40-400	Telescopic	3

Ideal Bypass Lopper

- Two-handed bypass lopper for cutting wet branches and shoots
- Applied gear increases cutting force
- Maximum cutting diameter 45mm
- Non-slip Safetouch™ surface provides secure grip and comfort in use
- Light, durable handles made of aluminium
- Blade coated with non-stick surface
- Available with standard or telescopic handles
- Telescopic option allows for easy and quick extension of the handle by an additional 31cm



Product No	Type	Pack
40-411	Standard	3
40-410	Telescopic	3

Ideal Anvil Lopper

- Two-handed anvil lopper designed for cutting dry branches and shoots
- Applied gear increases cutting force
- Maximum cutting diameter 45mm
- Non-slip Safetouch™ surface provides secure grip and comfort in use
- Light, durable handles made of aluminium
- Blade coated with non-stick surface
- Available with standard or telescopic handles
- Telescopic option allows for easy and quick extension of the handle by an additional 31cm



Product No	Type	Pack
40-413	Standard	3
40-412	Telescopic	3

Ideal Long Reach Bypass Lopper

- For cutting wet branches and shoots
- Maximum cutting diameter 25mm
- Non-slip Safetouch™ surface provides secure grip and comfort in use
- Light, durable shaft made of aluminium
- Includes safety switch
- Blade coated with non-stick surface
- Extends up to 2m

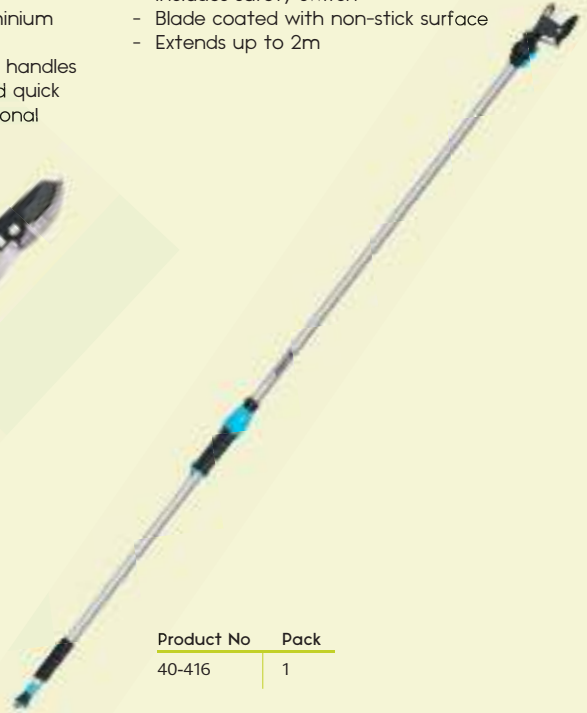

Product No	Pack
40-416	1

Ideal Bow Saw

- Universal bow saw designed for cutting wet and dry wood
- Blade made of high quality carbon steel C75S
- Induction hardened cutting teeth allow for safe and quick cutting and also limit saw clogging
- Equipped with solid latch tension which enables its replacement and adjusting correct blade tension
- Handle includes additional finger protection
- Steel frame



Product No	Size	Pack
40-420	533mm/21 inch	3
40-421	610mm/24 inch	3

Ideal Bow Saw Blades

- High quality blades designed for cutting wet or dry wood
- Made of high quality carbon steel C75S
- Induction hardened cutting teeth allow for safe and quick cutting and also limit saw clogging

Wet Wood

Product No	Size	Pack
41-055	533mm	5
41-056	610mm	5

Dry Wood

Product No	Size	Pack
41-057	533mm	5
41-058	610mm	5



Pop-Up Garden Bag

- Folds flat for easy storage
- Reusable and robust
- Lightweight
- Made from tear-resistant waterproof fabric
- Design includes carry handles for ease of use and emptying



Product No	Size	Pack
42-200	56L	6
42-201	172L	6

Garden Kneeling Pad

- Ergonomic design
- Made from durable material
- Ideal for use when kneeling for long periods of time when gardening
- Lightweight
- Waterproof



Product No	Size	Pack
42-211	40cm x 20cm	5
42-212	46cm x 28cm	5

Economic Gardening & Soil Gloves

- Lightweight gloves
- Made of flexible, airy and quick-drying polyester
- Covered with latex foam which provides a secure grip and comfort as well as protecting against moisture and dirt
- Complies with the requirements of EN 388 (3 1 3 1)
- Content: 40% polyester, 60% latex



Product No	Size	Pack
92-031	9/L	20

Basic Universal Metal Rake

- Ideal for leveling, breaking up clods of earth and raking grass
- A hole for hanging enables easy storage
- Working width 370mm, 14 teeth
- Length 1540mm, weight 0.8kg



Product No	Size	Pack
40-280	370mm	3

Basic Straight Spade

- Designed for work in hard soil, it allows easy and safe digging, planting, burrowing and removal of roots
- An ergonomic shaft ensures a correct, stable posture while working, and minimizes muscle tension
- The shape of the handle provides a sure and comfortable grip
- Robust and durable handle with a fiberglass composite
- The head is made of high-quality boron steel and is equipped with an integral, durable metal stand for the foot, providing support while driving the spade into the ground
- Length 1125mm, weight 1.8kg

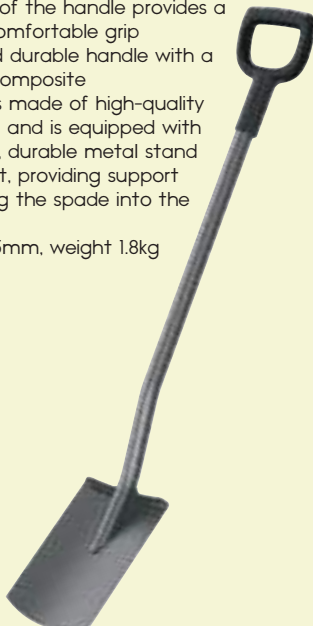

Product No	Pack
40-251	3

Basic Pointed Spade

- Designed for work in hard soil, it allows easy and safe digging, planting, burrowing and removal of roots
- An ergonomic shaft ensures a correct, stable posture while working, and minimizes muscle tension
- The shape of the handle provides a sure and comfortable grip
- An induction hardened head with high-quality boron steel reinforced with pressing
- The head of the spade is equipped with an integral, durable metal stand for the foot, providing support while driving the spade into the ground
- Length 1125mm, weight 1.8kg

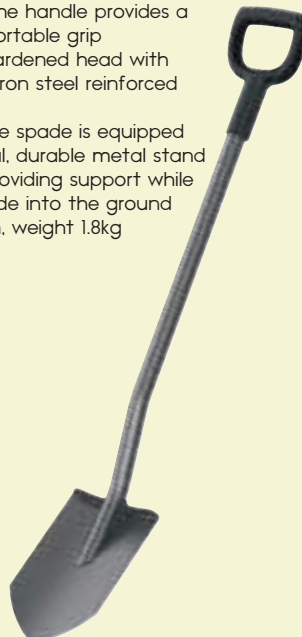

Product No	Pack
40-252	3

Basic Shovel

- Used for scooping and pouring bulk loose materials, sand, gravel, earth, etc
- Robust and durable handle with a fiberglass composite
- The shape of the handle provides a sure and comfortable grip
- Length 1210mm, weight 2kg



Product No	Pack
40-254	3



MADE WITH
**RECYCLED
MATERIALS**
UP TO 95%

growTM
GARDEN HOSE AND WATERING SYSTEM
MADE WITH RECYCLED MATERIALS

The GROW garden hose is the perfect choice for environmentally conscious homeowners. It is made from 55% recycled materials. GROW garden hose, featuring ATSTM technology, is a specially selected twill tricot braid of the highest quality yarn. It ensures that the hose straightens under water pressure, which prevents it from twisting and kinking. This not only increases its durability, but also significantly improves its comfort. The GROW line also includes hose quick connectors, tap adaptors and basic sprinklers. Perfect for any garden!

30 MORE THAN
YEARS
IN YOUR GARDEN

 **cellfast**[®]

Grow Garden Hose

- Six-layer hose
- Torsion-free, knot-proof, no water flow blocking
- ATS™ tricot braid
- Resistant to UV rays and algae build-up inside the hose
- Robust and flexible
- Temperature range -20/+60°C
- Long-lasting guarantee under proper conditions of use
- Burst pressure 27 bar
- Contains 55% of recycled materials
- Free from cadmium, barium, lead and phthalates



Product No	Size	Pack
13-500	15m x 0.5"	1
13-501	25m x 0.5"	1

Hobby Garden Hose

- Six-layer hose
- Anti-twist, resistant to knots blocking the stream of water
- ATS2™ double cross-tricot reinforcement
- Internal layer made of material suitable for contact with food
- UV stabilized
- Internal part resistant to algae
- Free from cadmium, barium and lead
- Temperature range -20/+60°C



Product No	Size	Pack
16-200	25m x 0.5"	1
16-201	50m x 0.5"	1

Stand Version

Product No	Size	Pack
16-295	60m x 0.5"	1
16-296	45m x 0.75"	1
16-297	25m x 1"	1

Grow Watering Set

- Watering set includes:
Grow Garden Hose
Grow Accessories:
Multifunctional Hand Sprinkler
Hose Quick Connector Water Stop
Hose Quick Connector Water Flow
Multi-Purpose Connector With Female Thread



Product No	Size	Pack
13-590	20m x 0.5"	1

Hobby Watering Set

- Watering set includes:
Hobby Garden Hose
Ergo Accessories:
Multifunctional Hand Sprinkler
Hose Quick Connector Water Stop
Hose Quick Connector Water Flow
Multi-Purpose Connector With Female Thread



Product No	Size	Pack
16-209	20m x 0.5"	1

Green Garden Hose

- Five-layer hose
- Anti-twist, resistant to knots blocking the stream of water
- ATS2™ double cross-tricot reinforcement
- Internal layer made of material suitable for contact with food
- UV stabilized
- Internal part resistant to algae
- Free of cadmium, barium and lead
- Temperature range -20/+60°C



Product No	Size	Pack
15-100	25m x 0.5"	1
15-101	50m x 0.5"	1

Ideal Garden Hose

- Four-layer hose
- Durable reinforcement made of high-quality yarn
- Cross braided
- Resistant to UV rays and algae build-up inside the hose
- Durable and flexible
- Burst pressure 27 bar
- Temperature range -20/+60°C
- 5-year guarantee under normal operating conditions



Product No	Size	Pack
10-240	20m x 0.5"	1
10-241	30m x 0.5"	1
10-242	50m x 0.5"	1

Smart Garden Hose

- Three-layer hose
- Anti-twist, resistant to knots blocking the stream of water
- ATS Variant tricot reinforcement
- UV stabilized
- Internal part resistant to algae
- Durable and flexible
- Temperature range -20/+60°C
- 5-year guarantee under normal operating conditions



Product No	Size	Pack
13-100	25m x 0.5"	1
13-101	50m x 0.5"	1



Green Watering Set

- Watering set includes:
Green Garden Hose
Ideal accessories:
Adjustable Hose Nozzle
Hose Quick Connector Water Stop
Hose Quick Connector Water Flow
Connector With Female Thread 3/4"



Product No	Size	Pack
15-109	20m x 0.5"	1

Ideal Watering Set

- Watering set includes:
Ideal Garden Hose
Ideal accessories:
Hydron Hand Sprinkler
Hose Quick Connector Water Stop
Hose Quick Connector Water Flow
Multi-Purpose Connector With Female Thread



Product No	Size	Pack
10-280	20m x 0.5"	1

Smart Watering Set

- Watering set includes:
Smart Garden Hose
Ideal accessories:
Adjustable Hose Nozzle
Hose Quick Connector Water Stop
Hose Quick Connector Water Flow
Connector With Female Thread 3/4"



Product No	Size	Pack
13-190	20m x 0.5"	1

Plus Garden Hose

- Three-layer hose
- Reinforcement made of the highest quality yarn
- UV stabilized, internal part resistant to algae
- Durable and flexible
- Temperature range -20/+60°C
- 5-year guarantee
- Most popular sizes available for display on a hose stand



Product No	Size	Pack
10-200	25m x 0.5"	1
10-201	50m x 0.5"	1

Stand Version

Product No	Size	Pack
10-750	70m x 0.5"	1
10-760	60m x 0.625"	1
10-770	60m x 0.75"	1
10-780	30m x 1"	1

Economic Garden Hose

- Three-layer hose
- Polyester cross reinforcement
- UV stabilized
- Internal part resistant to algae
- Traditional colour - transparent green
- Temperature range -10/+50°C
- Most popular sizes available for display on hose stand



Product No	Size	Pack
10-001	20m x 0.5"	1
10-002	30m x 0.5"	1
10-003	50m x 0.5"	1

Stand Version

Product No	Size	Pack
10-700	100m x 0.5"	1
10-720	70m x 0.75"	1
10-730	35m x 1"	1

Quattro Garden Hose

- Light, durable 4-layer hose
- Reinforcement made of the highest quality cross reinforcement yarn
- UV stabilized, internal part resistant to algae
- Burst pressure 20 bar
- Temperature range -10/+50°C
- Excellent usage properties even at low temperatures



Product No	Size	Pack
10-064	15m x 0.5"	1
10-065	25m x 0.5"	1
10-063	50m x 0.5"	1

Plus Watering Set

- Watering set includes:
Plus Garden Hose
Ideal Plus accessories:
Adjustable Hose Nozzle
Hose Quick Connector Water Stop
Hose Quick Connector Water Flow
Connector With Female Thread 3/4"



Product No	Size	Pack
10-290	25m x 0.5"	1

Economic Watering Set

- Watering set includes:
Economic Garden Hose
Adjustable Hose Nozzle
Quick Connector Water Stop
Quick Connector Water Flow
Connector With Female Thread 3/4"



Product No	Size	Pack
10-100	20m x 0.5"	1

Quattro Watering Set

- Watering set includes:
Quattro Garden Hose
Adjustable Hose Nozzle
Quick Connector Water Stop
Quick Connector Water Flow
Connector with Female Thread 3/4"



Product No	Size	Pack
10-091	15m x 0.5"	1

Multiflex Garden Hose

- Four-layer hose
- Anti-twist, resistant to knots blocking the stream of water
- ATS Variant™ tricot reinforcement
- Made with Velvet Technology™ - a highly flexible and pleasant to the touch hose structure that is exceptionally resistant to scratches and other mechanical damages
- Internal layer made of material suitable for contact with food
- UV stabilized
- Internal part resistant to algae
- Free of cadmium, barium and lead
- Temperature range -20/+60°C



Product No	Size	Pack
13-200	25m x 0.5"	1
13-201	50m x 0.5"	1

Yacht Prestige Watering Set

- Five-layer hose
- Includes Yacht ATSV™ hose, Multifunctional Hand Sprinkler, Quick Connector Water Stop, Hose Quick Connector Water Flow, Connector With Female Thread
- Features a convenient strap for fastening, transporting and hanging the hose
- Anti-twist, resistant to knots blocking the stream of water
- Highly resistant to salt water and UV rays
- Algae-resistant internal part
- Free of cadmium, barium and lead
- Temperature range -20/+60°C



Product No	Size	Pack
13-390	20m x 0.5"	3

ZygZag Expandable Hose

- An innovative and extremely compact garden hose
- Increases in length approximately two times during the flow of water under pressure
- After use, it contracts on its own
- Extremely light and very robust
- Its exterior fabric layer is pleasant to the touch, and the technology used ensures no kinking
- The watering set includes: ZygZag expandable hose Ergo Multifunctional Sprinkler Quick Hose Connectors



Product No	Size	Pack
19-041	7.5m	6
19-042	15m	6

Spring Irrigation Hose

- Three-tube irrigation hose with a set of nozzles
- Guarantees even watering at the whole length of the hose
- Saves water and time
- Water consumption depending on working pressure: 1 bar - 5.5 l/h per 1m; 2 bar - 9 l/h per 1m; 3 bar - 14.5 l/h per 1m
- UV-stabilized
- Free of cadmium and barium



Product No	Size	Pack
19-021N	7.5m x 0.5"	10
19-022N	15m x 0.5"	10

Drip Weeping Hose

- Dripping hose for economical and precise plant watering
- Saves up to 70% of water by eliminating evaporation
- Can be placed on or under the surface of the ground (recommended depth 15-20cm)
- Water consumption depending on working pressure: 1 bar - 10 l/h per 1m; 2 bar - 17.5 l/h per 1m; 3 bar - 25 l/h per 1m
- Can run at very low water pressure
- Fixed nozzles for a hose quick connection
- Best performance while watering hedges, flowerbeds, rock gardens and vegetable beds



Product No	Size	Pack
19-001	7.5m x 0.5"	1
19-002	15m x 0.5"	1

Ideal Connection Set

- Connection set for fixing hose cart or reel with tap
- Set includes: garden hose 1.5m, tap connector, quick hose connectors water stop and water flow



Product No	Pack
55-998N	4

Ideal Garden Hose Hanger

- Convenient wall hanger for hose
- Capacity of 25/30m of garden hose
- Equipped with handles for hanging sprinklers or tools



Product No	Pack
55-993	10

Corner Wall Hose Guide

- The perfect tool to protect and guide hoses around corners
- Wall mountable
- Helps eliminate kinks and twists



Product No	Pack
52-190	6

Ground Spike Hose Guide

- The perfect tool to protect and guide hoses around the garden
- Helps eliminate twists and kinks
- With ground spike for stability



Product No	Pack
52-191	6

Ergo Automatic Hose Reel

- A durable wall hanger facilitates the stable installation of the reel and allows rotation within a 180° range
- Metal elements reinforce the connection between the hose reel and the hanger, ensuring secure usage
- A reliable spring mechanism enables the unreeling of the appropriate hose length and facilitates automatic reeling
- Ergonomic handles on both sides of the hose reel make it easy to carry and mount onto the hanger
- The worm mechanism of the hose guide ensures proper reeling
- Centrifugal brake ensures safe hose reeling speed



Product No	Size	Pack
55-410	20m + 2m x 0.5"	1
55-420	30m + 2m x 0.5"	1

Ergo XS Hose Reel

- Modern and functional hose reel in a set with 10m hose
- Compact, lightweight and durable
- Folding handle ensures convenient transportation
- Profiled rotation crank handle facilitates winding the hose
- Holders for sprinklers and connectors situated on both sides of the reel
- Hanger included on the set to enable hanging the reel on a wall



Product No	Size	Pack
55-400	10m x 0.375"	3

Aluplus Hose Reel

- Convenient transportation and hose storage
- Easy assembly without tools
- Corner hose connection prevents hose from warping, kinking or twisting while winding on and off
- Comfortable rubber handle
- Aluminum tubes resistant to corrosion



Product No	Capacity	Pack
55-150	45m x 0.5"	1
55-160	60m x 0.5"	1

Aluplus Hose Cart

- Convenient transportation and hose storage
- Easy assembly without tools
- Corner hose connection prevents hose from warping, kinking or twisting while winding on and off
- Comfortable rubber handle
- Aluminum tubes resistant to corrosion



Product No	Capacity	Pack
55-250	45m x 0.5"	1
55-260	60m x 0.5"	1

Discover Hose Cart

- Hose cart base that grips the surface and provides stability during the unreel of the hose
- Adjustable handle length
- Comfortable rubber handle
- Functional folding handle
- Handles for convenient storage connectors and sprinklers
- Ergonomic folding hose cart base
- Aluminum tubes resistant to corrosion
- Reinforced wheels



Product No	Capacity	Pack
55-600	60m x 0.5"	1

Explorer Metal Hose Cart

- Made of high quality steel and aluminium
- Reel shape makes winding the hose easier and prevents it from kinking
- Functional folding crank handle with ergonomic shape
- Wide base provides easy and stable running
- Construction ensures convenient transportation and storage of long lengths of the hose
- Anchorable feet provide stability during unreeling the hose
- Adjustable handle length
- Comfortable rubberized handle



Product No	Capacity	Pack
55-050	60m x 0.5"	1

Compact Hose Cart Set

- Set contains:
Compact Hose Cart
0.5 inch garden hose 20m
Ideal Adjustable Hose Nozzle
Ideal Quick Hose Connector Water Stop
Ideal Quick Hose Connector Water Flow



Product No	Size	Pack
55-310	20m x 0.5"	1

Discover Hose Cart Set

- Set contains:
Discover Hose Cart
Multiflex Garden Hose
Ergo Multifunctional Sprinkler
Ergo Quick Hose Connector Water Stop
Ergo Quick Hose Connector Water Flow
Connection Set



Product No	Size	Pack
55-620	20m x 0.5"	1
55-625	25m x 0.5"	1
55-630	30m x 0.5"	1

Explorer Metal Hose Cart Set

- Set contains:
Explorer Metal Hose Cart
Multiflex Garden Hose
Ergo Multifunctional Hand Sprinkler
Ergo Quick Hose Connector Water Stop
Ergo Quick Hose Connector Water Flow
Connection Set



Product No	Size	Pack
55-065	25m x 0.5"	1
55-060	50m x 0.5"	1

Ergo Hose Repairer

- For the permanent connection of two hoses with the same or different diameters
- Extended clench mechanism ensures accurate and effective connection to the hose
- Ergonomic shape ensuring a reliable and comfortable grip



Product No	Size	Pack
53-100	0.5-0.625"	8

Ergo Quick Hose Connector Water Stop

- Internal stop mechanism – stops the flow of water to enable easy changing of sprinklers without having to alter the water supply
- Extended clench mechanism ensures accurate and effective connection to the hose
- Safetouch system protects the product against accidental damage while providing a reliable and comfortable grip
- Spring mechanism made of stainless steel
- PC/ABS plastics, three clamps



Product No	Size	Pack
53-120	0.5"	8

Ergo Quick Hose Connector Water Flow

- Extended clench mechanism ensures accurate and effective connection to the hose
- Safetouch system protects the product against accidental damage while providing a reliable and comfortable grip
- Spring mechanism made of stainless steel
- PC/ABS plastics, three clamps

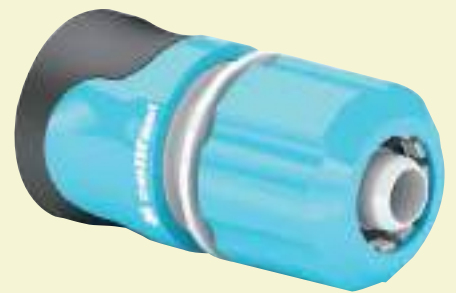

Product No	Size	Pack
53-130	0.5"	8

Ergo Connector With Female Thread

- Multi-purpose connector with female thread
- Fits 1/2", 3/4" and 1" taps
- Ergonomic shape for easy connection to the water source



Product No	Size	Pack
53-210	0.5-0.75-1"	8

Ergo Connector With Male Thread

- Male connector for inserting into the female connector of the water source
- Construction enables use of a key for easier assembly



Product No	Size	Pack
53-230	0.5"	8

Ergo 2-Way Hose Connector

- For the easy separation and connection of hoses when used with 1/2" or 3/4" quick hose connectors



Product No	Pack
53-200	8

Ergo 3-Way Hose Connector

- For the easy separation and connection of hoses when used with 1/2" or 3/4" quick hose connectors



Product No	Pack
53-205	8

Ergo Universal Angle Connector With Female Thread

- Ergonomic shape for quick and convenient connection to the water source
- Possibility of 360° horizontal and 180° vertical swivel
- Suitable for 1/2", 3/4" and 1" taps
- ABS material



Product No	Size	Pack
53-250	0.5", 3/4", 1"	6

Ergo Double Distributor

- Enables a simultaneous connection of two devices to one tap
- The valves with clear opening and closing signs allow for an intuitive and smooth control of the water flow
- The flow can be adjusted separately for each output
- Made of a durable fiberglass composite
- Fits 1/2", 3/4" and 1" taps



Product No	Pack
53-220	3

Ergo Adjustable Hose Nozzle

- High quality ergonomic sprinker with non-gradual water flow regulation
- Clearly marked adjustable water stream from jet through to a narrow stream or a delicate mist
- Safetouch system protects the product against accidental damage while providing a reliable and comfortable grip



Product No	Pack
53-300	8

Ergo Multifunctional Sprinkler

- High quality, ergonomic sprinker with adjustable water flow regulation
- Clearly marked adjustable water stream from jet through to a narrow stream, heavy and light shower or a delicate mist
- Safetouch system protects the product against accidental damage while providing a reliable and comfortable grip



Product No	Pack
53-310	6

Ergo Hand Sprinkler

- High quality, ergonomic sprinker with adjustable water flow regulation
- Clearly marked adjustable water stream from a narrow jet through to a delicate mist
- Intuitive regulation of water flow
- Safetouch system protects the product against accidental damage while providing a reliable and comfortable grip
- Hang up system enables the sprinkler to be hung anywhere hence ensuring the sprinkler is kept clean and safe after use



Product No	Pack
53-320	4

Ergo Multifunctional Hand Sprinkler

- High-class, ergonomic multifunctional hand sprinkler with non-gradual water flow regulation
- Clearly marked adjustable water stream from jet through to a narrow stream, heavy and light shower or a delicate mist
- Intuitive regulation of water flow
- Safetouch system protects the product against accidental damage while providing a reliable and comfortable grip
- Hang up system enables the sprinkler to be hung anywhere hence ensuring the sprinkler is kept clean and safe after use



Product No	Pack
53-330	4

Ergo 4-Functional Hand Sprinkler

- Premium quality, four function hand sprinkler with graduated water flow regulation
- Clearly marked adjustable water functions; shower, rainfall, jet and flat
- Intuitive regulation of water flow
- Safetouch system protects the product against accidental damage while providing a reliable and comfortable grip
- Hang up system enables the sprinkler to be hung anywhere hence ensuring the sprinkler is kept clean and safe after use



Product No	Pack
53-340	4

Ergo Multifunctional Lance

- Non-gradual change of functions
- Legible markings ease the choice of suitable type of water stream, which is available as strong jet, delicate mist and heavy or light shower
- Intuitive regulation of the water flow
- Safetouch system provides a reliable grip and comfort of use, as well as the protection against accidental damage



Product No	Pack
53-480	2

Ergo Set With Multifunctional Hand Sprinkler

- Premium quality, complete Ergo set with Multifunctional Hand Sprinkler and accessories: Ergo Quick Hose Connector Water Stop, Ergo Quick Hose Connector Water Flow, Ergo Connector With Female Thread



Product No	Pack
53-530	4

Ergo Set With 4-Functional Hand Sprinkler

- High-class, complete Ergo set with a 4-Functional Hand Sprinkler and accessories: Ergo Quick Hose Connector Water Stop, Ergo Quick Hose Connector Water Flow, Ergo Connector With Female Thread



Product No	Pack
53-540	4

Ergo Regulated 4-Functional Lance

- Head inclination adjustable in the range of 0-180°
- Hanging hole enables easy storage
- Non-gradual change of functions
- Legible markings ease the choice of suitable type of water stream, which is available as shower, rainfall and strong or flat jet
- Intuitive regulation of the water flow
- Safetouch system provides a reliable grip and comfort of use, as well as the protection against accidental damage

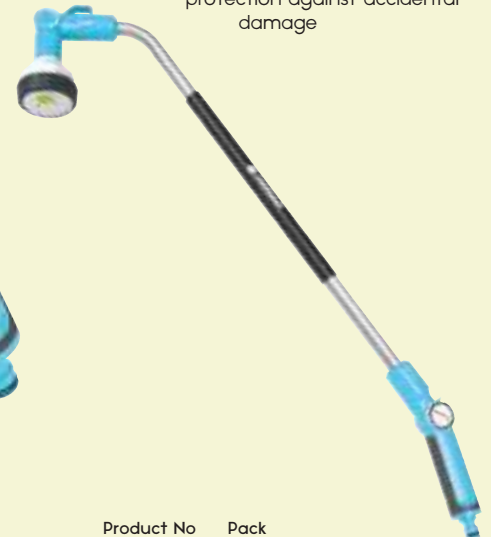

Product No	Pack
53-485	2

Ergo Rotating Sprinkler On Spike

- Ergonomic rotating sprinkler with spike base
- Three-arm rotating sprinkler, 12 nozzles
- Sprinkling diameter ca. 15m, sprinkling coverage area ca. 170m²
- Even sprinkling of the irrigated surface thanks to precise arrangement of nozzles
- Legible markings help to accurately set the rotating speed and sprinkling coverage area



Product No	Pack
53-415	4

Ergo Rotating Sprinkler On Base

- Ergonomic rotating sprinkler with triangle base
- Three-arm rotating sprinkler, 12 nozzles
- Sprinkling diameter ca. 15m, sprinkling coverage area ca. 170m²
- Even sprinkling of the irrigated surface thanks to precise arrangement of nozzles
- Legible markings help to accurately set the rotating speed and sprinkling coverage area
- Foldable spikes stabilise the sprinkler during operation



Product No	Pack
53-460	4

Ideal Universal O-Ring Set

- Spare set of gaskets dedicated for watering tools and accessories



Product No	Pack
50-725	5

Ideal Connector With Female Thread

- For a water source with a male thread
- Available in 30 piece display unit



Product No	Size	Type	Pack
50-650	0.5"	Single	5
51-650	0.5"	Display	1
50-655	0.75"	Single	5
51-655	0.75"	Display	1

Ideal Multi-Purpose Connector With Female Thread

- Fits 1/2", 3/4" and 1" taps
- Ergonomic shape for easy connection to the water source



Product No	Size	Type	Pack
50-652	0.5"-0.75"-1"	Single	5
51-652	0.5"-0.75"-1"	Display	1

Ideal Connector With Male Thread

- For a water source with a female thread



Product No	Size	Pack
50-665	0.5"	5

Ideal 2-Way Hose Connector

- For temporary connection of hoses equipped with quick hose connectors



Product No	Size	Pack
50-640	0.5"	5

Ideal 3-Way Hose Connector

- For temporary connection of hoses equipped with quick hose connectors



Product No	Size	Pack
50-645	0.5"	5

Ideal Multi-Purpose Tap Connector

- For connecting to round and oval indoor spout taps
- The fitting is sealed to the tap by tightening the stainless steel clip



Product No	Size	Pack
52-661	0.5"	6

Ideal Multi-Purpose Connector With Adaptor

- For connection it is required to replace the standard aerator with an adaptor attached to the connector
- Equipped with a clip, allowing for quickly and conveniently installing the water intake connection
- Fits taps with an outer diameter of 22mm and an internal diameter of 24mm
- The design enables efficient installation without tools



Product No	Pack
52-255	5

Ideal Quick Hose Connector With Valve

- Allows a change of connecting devices, even when water pressure is high
- Secured at the hose outlet for conveniently adjusting and switching off the water flow



Product No	Size	Pack
52-330	0.5"	5

Ideal Quick Hose Connector Water Stop

- Stop function enables the exchange of sprinklers or stopping sprinkling without turning off the water supply
- Clench mechanism elements made of stainless steel
- PC/ABS material
- Three clamps
- Available in 30 piece display unit



Product No	Size	Type	Pack
50-620	0.5"	Single	5
51-620	0.5"	Display	1

Ideal Quick Hose Connector Water Flow

- Clench mechanism elements made of stainless steel
- PC/ABS material
- Three clamps
- Available in 30 piece display unit



Product No	Size	Type	Pack
50-630	0.5"	Single	5
51-630	0.5"	Display	1

Ideal Hose Repairer

- For permanent connection of two hoses
- PC/ABS material
- Available in 30 piece display unit

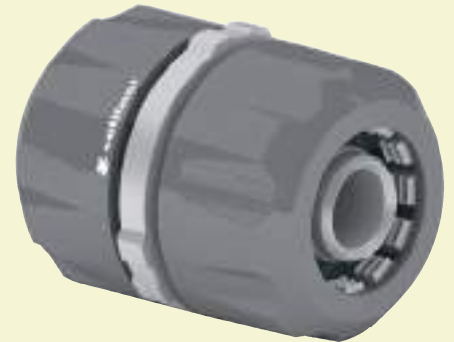

Product No	Size	Type	Pack
50-600	0.5"	Single	5
51-600	0.5"	Display	1

Ideal Double Distributor

- Enables a simultaneous joining of two devices to one tap
- The water flow may be adjusted for each output separately
- Smooth regulation and cut-off function
- While using appropriate extension connectors, there is possibility to connect the distributor with hoses of different diameters
- Fits 3/4" and 1" taps



Product No	Pack
52-220N	2

Ideal Quaternary Distributor

- Enables the simultaneous joining of four devices to one tap
- The water flow may be adjusted for each output separately
- Smooth regulation and cut-off function
- While using appropriate extension connectors, there is possibility to connect the distributor with hoses of different diameters
- Fits 3/4" and 1" taps



Product No	Pack
52-240N	3

Ideal Adjustable Hose Nozzle

- Handy sprinkler with non-gradual water stream regulation from strong jet to delicate mist
- ABS material construction



Product No	Pack
50-700	5

Ideal Rain Hand Sprinkler

- Hand sprinkler made of high quality plastics
- Gradual regulation of the water stream in 6 different settings
- One-handed adjustment of the stream strength
- Possibility of locking the trigger at the maximum stream strength



Product No	Pack
50-738	5

Ideal Hydron Hand Sprinkler

- Hand sprinkler made of high quality plastics
- Full and smooth regulation of the water stream
- Sprinkling starts after pulling the trigger which can be also used to regulate the flow strength and to lock the fixed stream



Product No	Pack
50-737	5

Ideal Set With Adjustable Hose Nozzle

- Set contains:
Adjustable Hose Nozzle,
Ideal Quick Hose Connector Water Stop,
Ideal Quick Hose Connector Water Flow,
Ideal Connector With Female Thread



Product No	Pack
50-705	5

Ideal Set With Rain Hand Sprinkler

- Set Contains
Rain Hand Sprinkler,
Ideal Quick Hose Connector Water Stop,
Ideal Quick Hose Connector Water Flow,
Ideal Connector With Female Thread



Product No	Pack
50-762	5

Ideal Set With Hydron Hand Sprinkler

- Set Contains
Hydron Hand Sprinkler,
Ideal Quick Hose Connector Water Stop,
Ideal Quick Hose Connector Water Flow,
Ideal Connector With Female Thread



Product No	Pack
50-760	5

Ideal Pulse 2 Hand Sprinkler

- Made of metal and high quality plastics
- Infinitely adjustable water stream from strong to spiral jet
- Possibility of locking the trigger at the maximum stream strength
- Ergonomic handle provides a secure grip and does not slip, which aids working comfort
- The Safetouch system provides a reliable grip and comfort of use, as well as protecting the product against accidental damage
- One-hand stream strength adjustment



Product No	Pack
52-027	4

Ideal Pulse 3 Hand Sprinkler

- Made of metal and high quality plastics
- Adjustable water stream in 3 different settings: spiral, straight, flat
- The Safetouch system provides a reliable grip and comfort of use, as well as protecting the product against accidental damage
- Activation of irrigation by pressing a button, which also enables to regulate the strength of the stream and possibility of locking the trigger at the maximum stream strength



Product No	Pack
52-028	4

Ideal Pulse 6 Hand Sprinkler

- Made of metal and high quality plastics
- Adjustable water stream in 6 different settings: strong and gentle shower, spiral, straight, mist and flat
- One-hand stream strength adjustment
- The Safetouch system provides a reliable grip and comfort of use, as well as protecting the product against accidental damage
- Ergonomic handle provides a secure grip and does not slip, which aids working comfort



Product No	Pack
52-029	4

Ideal Jet Hand Sprinkler

- Ergonomic hand sprinkler made of high quality plastics
- Non-gradual regulation of the water stream from strong jet to delicate mist
- The Safetouch system provides a reliable grip and comfort in use, as well as protecting the product against accidental damages
- One-handed adjustment of stream strength



Product No	Pack
52-026	3

Ideal Uni Hand Sprinkler

- Ergonomic hand sprinkler made of high quality plastics
- Non-gradual regulation of water stream from strong jet to delicate mist
- One-handed adjustment of stream strength



Product No	Pack
52-050N	12

Ideal Mix Hand Sprinkler

- 8 function, ergonomic hand sprinkler made of high quality plastics
- Gradual regulation of water stream in 8 different settings
- One-handed adjustment of stream strength



Product No	Pack
52-055N	12

Ideal Profi Hand Sprinkler

- Made of aluminium and plastic
- Non-gradual regulation of water stream and its strength from strong jet to delicate mist
- Convenient trigger lock



Product No	Pack
52-010N	12

Ideal Economic Oscillating Sprinkler

- Oscillating sprinkler made from high quality plastics
- Equipped with 15 nozzles
- Smooth regulation of irrigation area
- Coverage up to 255m²

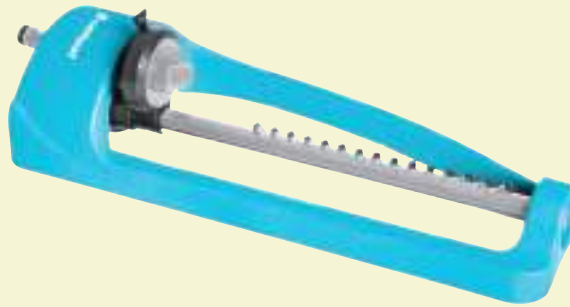

Product No	Pack
52-071N	3

Ideal Turbo Swinging Sprinkler

- Swinging sprinkler made from high quality plastics and aluminium
- Equipped with 18 nozzles
- Smooth sector regulation of irrigation area
- Coverage up to 240m²



Product No	Pack
52-070N	3

Ideal Opti Swinging Sprinkler

- Swinging sprinkler made from high quality plastics
- Equipped with 20 nozzles, 6 of which are configured with a possibility of switching on and off
- Smooth regulation of water flow and convenient mechanism of sprinkling range regulation
- Coverage up to 263m²



Product No	Pack
52-075N	3

Ideal Multi Sector Sprinkler

- 4 function sprinkler with spike base
- Made from high quality plastic
- Gradual regulation of water stream in 4 different settings
- Angle of sprinkling gradually adjustable from 20° to 360°
- Possibility of setting sprinkling area with movable head of the sprinkler
- Coverage up to 346m²
- Modular system that can be extended with more sprinklers



Product No	Pack
52-060N	8

Ideal Telescopic Watering Lance

- 6-function extendable watering lance
- Made of high quality plastics and aluminium
- Gradual regulation of the water stream in 6 different settings
- Extension suitable for watering plants in places that are hard to reach
- One-handed adjustment of the stream strength
- Sprinkling tip adjustable up to 180°
- Can also be used as a garden shower



Product No	Pack
52-080N	5

Basic Connector With Male Thread

- For a water source with a female thread



Product No	Size	Pack
50-230	0.5"	5
50-235	0.75"	5

Basic Connector With Female Thread

- For a water source with a male thread
- 30 piece counter display option available



Product No	Size	Type	Pack
50-210	0.5"	Single	5
51-210H	0.5"	Display	1
50-215	0.75"	Single	5
51-215H	0.75"	Display	1

Basic Hose Connector

- For temporary connection of hoses equipped with quick hose connectors



Product No	Size	Type	Pack
50-200	0.5"	2 way	5
50-205	0.5"	3 way	5

Basic Quick Hose Connector Water Stop

- Sprinkler exchange is possible without stopping main water flow
- Clench mechanism made of stainless steel
- ABS material, three clamps
- 30 piece counter display option available



Product No	Size	Type	Pack
50-120	0.5-0.625"	Single	5
51-120H	0.5-0.625"	Display	1

Basic Quick Hose Connector Water Flow

- Clench mechanism made of stainless steel
- ABS material, three clamps
- 30 piece counter display option available



Product No	Size	Type	Pack
50-130	0.5-0.625"	Single	5
51-130H	0.5-0.625"	Display	1

Basic Hose Repairer

- For permanent connection of two hoses
- 30 piece counter display option available



Product No	Size	Type	Pack
50-100	0.5"	Single	5
51-100H	0.5"	Display	1

Basic Adjustable Hose Nozzle

- Handy sprinkler with non-gradual water flow regulation from narrow to wide



Product No	Pack
50-300	5

Basic Adjustable Hose Nozzle Set

- Set contains: Adjustable Hose Nozzle, Economic Quick Hose Connector Water Stop, Economic Quick Hose Connector Water Flow, Economic Connector With Female Thread



Product No	Pack
50-500	5

Basic Multiclik Static Sprinkler

- Multifunctional fixed sprinkler with five types of flow depending on area size
- Perfect for small areas



Product No	Pack
50-445	5

Cellfast Watering Displays

Contact us for further details



Multi-Purpose Sprayer

- Budget sprayer for use anywhere in the home
- Ideal for water-soluble products
- Supplied in assorted colours
- Adjustable nozzle for fan and jet delivery



Product No	Size	Pack
STV087	330ml	100

All Ways Fat Bottom Sprayer

- Sprayer works any way up
- In four decorative colours
- Fat bottom stability stops spills
- Use it for any water soluble product
- Fully adjustable fan and jet spray for optional droplet size



Product No	Size	Pack
STV065	750ml	12

Vintage Glass Plant Mist Sprayer

- Attractive and elegant handheld mist sprayer for indoor plants
- Supplied in mixed 3 colour pack - clear, purple and green
- With easy pump action
- Supplied in full-colour gift box



Product No	Size	Pack
STV066	225ml	6

All Ways 360° Home & Garden Sprayer

- Uniquely versatile sprayer that performs at all angles
- Persistent spray action in all directions without the need to keep the bottle upright
- Adjustable nozzle
- Adjust the sprayer cap to change the flow of water from a spray to a direct jet
- For use with pesticides, and fertilisers etc
- Not suitable for use with solvents
- Versatile use for flower gardens, vegetable patches, pets, workshops and cleaning in the home and garden
- Embossed gradients marking on the bottle in fl oz and ml



Product No	Size	Pack
STV092	500ml	12
STV093	1L	12

Multi-Use Pressure Sprayer

- Sprayer works at all angles, including upside down
- Adjustable spray nozzle and trigger lock
- Corrosion-proof plastic tank
- Safe for use with garden chemicals and pesticides



Product No	Size	Pack
STV084	1L	12
STV091	2L	6

Heavy Duty Pressure Sprayer & Lance

- Pump action pressure sprayer with pressure release valve and lockable trigger mechanism
- Detachable lance for long-reach spray applications
- Translucent graduated bottle in milliliters for accurate filling and mixing
- Use with soluble products including pesticides, herbicides, insecticides, fungicides, and fertilisers



Product No	Size	Pack
STV033	1.5L	6

Multi-Purpose Pressure Sprayer

- Sturdy, frost-proof, translucent tank with gradient markings in litres and gallons for accuracy when filling
- Pump-action pressurisation with a safety pressure release valve
- Adjustable spray nozzle and the trigger lock allows for a continuous flow without the need to maintain grip
- Ideal for use in gardens and other large outdoor areas with water and soluble products such as fertilisers and pesticides. Not suitable for solvents
- Usage illustrations printed onto the body of the tank



Product No	Size	Pack
STV085	2L	6
STV095	5L	6
STV082	8L	6

Heavy Duty Fence & Timber Sprayer

- Specially engineered for easy and accurate application of all water-based timber treatments
- Ideal for treating fences, decking, garden sheds, and all types of outdoor woodwork
- Integrated easy-fill funnel, lockable lance and trigger, and adjustable brass nozzle



Product No	Size	Pack
STV034	5L	6

Multi-Purpose Wheeled Pressure Sprayer

- Patio and garden portability takes the lift out of spraying any garden care product
- Suitable for all water-based sprays, including plant protection, herbicides, foliar feeds, as well as cleaners and disinfectants
- Pressure release valve and lance cradle ensuring easy portability
- Adjustable nozzle and trigger lock for easy and accurate spray treatments



Product No	Size	Pack
STV032	8L	4

Multi-Purpose Knapsack Pressure Sprayer

- Fast-action piston pump for high pressure flow through ergonomic hand lance with trigger lock
- Body curve design and fully adjustable carrier straps
- Airtight, leak-proof construction



Product No	Size	Pack
STV030	12L	1

Multi-Mix Hose End Sprayer

- Thru-hose sprayer ideal for soluble plant food and nematode treatments
- No calibration needed - automatically mixes and applies soluble sprays
- On/off switch and even fan-shaped spray applicator
- Attaches to all standard hose connections



Product No	Size	Pack
STV035	750ml	6

Recycled Soda Bottle Pressure Sprayer

- Recycle a soda bottle and help to save the planet!
- Fits most brands of bottle with a simple screw-top fixture
- Pressure pump with mist or jet sprayer and push-button activation



Product No	Pack
STV036	12

Garden Spray Cone

- Provides protection for surrounding plants when spraying
- Fits all Defenders pressure sprayers
- Suitable to use in windy conditions
- Easy to clean, and re-usable



Product No	Pack
STV037	6

T-Bar Sprayer

- Double-headed spray wand attachment for wider coverage on lawns and gardens
- Ideal for larger treatments using herbicide and insecticide sprays
- Fits all Defenders pressure sprayers
- Adjustable mist and jet nozzle



Product No	Pack
STV039	6

No-Spill Spouted Watering Jug

- No-spill design ideal for watering plants and pots indoors or out
- Long-reach spout for small or hard to reach areas
- Supplied in assorted colours



Product No	Size	Pack
STV069	1L	12
STV068	1.5L	12

3-Piece Funnel Set

- Funnel dry goods or liquids accurately and without spills
- Choice of 3 sizes for optimal fill rates
- Use hang holes or nest together for easy storage
- Translucent - easy to clean



Product No	Pack
STV038	12

All-Seasons Multi-Purpose Handy Spreader

- Ideal for easy and even application of granules and seeds
- Rotatable lid for adjustable application rates
- Air and water-tight closure
- Handy scoop included to refill



Product No	Pack
STV027	6

All-Seasons Multi-Purpose Rotary Spreader

- Lightweight rotary spreader for handheld applications
- Ideal for grass and flower seeds, fertilisers, and rock salt during winter
- 3.5L capacity with 3 adjustable settings for different flow rates



Product No	Pack
STV029	6

Path & Patio Cleaner

- Non-acid formula concentrate
- Children and pet friendly when dry
- Treats up to 25m²



Product No	Size	Pack
STV940	2L	6

Grip 'N' Grab Picker

- Patented sure-grip jaws for a precision pick
- Enables 1.5m reach and pick from 1g up to 1kg
- Lightweight design with easy trigger action for arthritic and elderly users



Product No	Pack
STV333	1

Trigger Picker

- Entry level trigger picker
- Provides 80cm of extended reach
- Lightweight and easy to use
- Picks up to 0.5kg



Product No	Pack
STV330	1

Heron

- Standing grey heron deters other birds from preying ponds and fisheries
- 30" high and fitted with a detachable fixing stake
- Natural colouring and durable construction



Product No	Pack
STV955	1

Defenders®

**slugs
away**

**ALL-NATURAL
WOOL PELLETS**



Nourish & Protect Your Plants

**Grow Bumper
Crops Naturally**

Slugs Away Wool Pellets

- Wool-based pellets naturally deter slugs and snails without using chemical controls
- Forms a blanket mulch when watered or after rainfall
- Suitable for organic gardening, with natural slow-release of plant nutrients from manure
- Also acts as a weed suppressant and reduces the need for watering plants

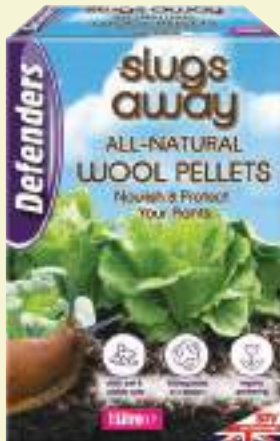

Product No	Size	Pack
STV051	1L	6
STV052	3.5L	3
STV053	5L	1

Slugs Away Wool Mat

- 100% organic wool mat naturally deters slugs and snails without chemical controls
- Suitable for organic gardening and use around fruit and vegetables
- Also acts as a weed suppressant and soil insulator
- 100% biodegradable and safe for use around children and pets



Product No	Size	Pack
STV058	60cm x 80cm	12

Slugs Away Gel

- A natural non-toxic barrier to protect plants and crops from slugs and snails
- Harmless to children, pets and wildlife
- Effective in wet and dry conditions
- Each application lasts up to 2 weeks



Product No	Size	Pack
STV096	650ml	6

Slugs Away Traps

- Safely trap and catch slugs and snails
- Value-for-money twinpack
- Supplied with poison-free bait
- Suitable for organic gardening
- Unobtrusive and reusable design



Product No	Pack
STV090	6

Slugs Away Barrier Tape

- Single-use copper tape creates a natural barrier ideal for use around plant pots, greenhouse staging and planters
- Poison-free and easy to use
- 4m pack with adhesive backing
- Protect up to 12no. 5" pots



Product No	Pack
STV097	6

Slugs Away All-Natural Repellent Kit

- Enjoy slug-free season without using poison baits and chemicals
- All-natural deterrents for season-long protection of vulnerable plants
- Suitable for organic gardening
- Kit includes STV051, STV097, STV096, and STV058



Product No	Pack
COM036	6

Bug & Mildew Control

- Physical control of aphid, whitefly, red spider mite and more
- Controls powdery mildew by washing away the spores
- Provides the plants with nutrients for healthy growth
- Pesticide free, uses physical mode of action to stop pests



Product No	Size	Pack
ECF0024	1L	6
ECF0060	200ml Refill	12

Bug Control

- Controls greenfly, blackfly, spider mite, scale insect and more
- Suitable for indoor and outdoor use
- Use on edible and ornamental plants
- Pesticide free, uses physical mode of action to stop pests



Product No	Size	Pack
ECF0028A	1L	6
ECF0061	200ml Refill	12

Rose Defender

- Physical control of aphid, whitefly, red spider mite and more
- Controls powdery mildew by washing away the spores
- Provides nutrients for vibrant healthy roses
- Pesticide free, uses physical mode of action to stop pests



Product No	Size	Pack
ECF0020	1L	6
ECF0063	200ml Refill	12

Plant Disease Defence

- Triggers plants natural immune response prior to stress and disease attack
- Builds a resistance to common garden diseases such as mildews, leaf spot, rust, canker and other bacterial and fungal pathogens
- For all plant types



Product No	Size	Pack
ECF0065	1L	6
ECF0066	200ml Refill	12

Slug Defence Plant Spray

- Effective prevention against slug and snail damage without hurting them
- Contains nutrients to promote plant growth
- Pesticide free, for all garden types



Product No	Size	Pack
ECF0067	1L	6
ECF0068	200ml Refill	12

Slug Defence Barrier Granules

- Natural non-toxic granules for slug and snail control
- Provides an effective physical barrier
- Long lasting granules which dry quickly and remain effective after rain or watering
- Pesticide free, for all garden types



Product No	Size	Pack
ECF0008	2L	6

Organic Tomato Feed

- High quality organic based liquid feed
- Encourages large crops of delicious fruit and strong, healthy growth
- Suitable for organic growing
- Concentrate makes up to 50 watering cans



Product No	Size	Pack
ECF0044	1.5L	6

Organic Wonder Feed

- High quality organic based liquid feed
- With added biostimulant to encourage nutrient uptake and enhance plant development
- Feeds all plant types, promoting healthy and abundant growth
- Concentrate makes up to 50 watering cans



Product No	Size	Pack
ECF0037	1.5L	6

Organic Pour & Feed

- High quality organic based liquid feed
- With added biostimulant to encourage nutrient uptake and enhance plant development
- Feeds all plant types, promoting healthy and abundant growth
- Ready to use – simply pour and feed



Product No	Size	Pack
ECF0034	1.5L	6
ECF0069	200ml Refill	12

NEW!

ecofective®

ORGANIC SUPERFOOD

The right choice for the planet

liquid feeds

OUR POUCH USES
UP TO
70%
LESS PLASTIC



The award-winning Organic Superfood range is growing. Promoting bigger, healthier, and happier plants, fruit and vegetables, Organic Superfood liquid feeds provide great results for gardeners with increased crop yields and bigger brighter blooms! These feeds are packaged in a flexible pouch, which uses up to 70% less plastic and promotes a 50% extra message on pack.

Boost your sales with ecofactive® Organic Superfood

Organic Superfood All Plants Concentrate

- For happier, healthier plants, fruit and veg
- Liquid feed and root booster
- Enhanced with seaweed
- Suitable for organic growing
- Makes up to 50 watering cans
- Supplied in a flexible pouch, using up to 70% less plastic



Product No	Size	Pack
ECF0104	1.2L	6

Organic Superfood For Tomatoes Concentrate

- For happier, healthier tastier tomatoes
- Liquid feed and root booster
- Enhanced with seaweed
- Suitable for organic growing
- Vegan friendly
- Makes up to 50 watering cans
- Supplied in a flexible pouch, using up to 70% less plastic



Product No	Size	Pack
ECF0106	1.2L	6

Organic Seaweed All Plants Concentrate

- For bigger crops and blooms
- A natural growth stimulant
- Produced from the best sources of organic seaweed
- Provides all plant types with an extra tonic boost
- 100% cold pressed
- Supplied in a flexible pouch, using up to 70% less plastic



Product No	Size	Pack
ECF0108	1.2L	6

Organic Superfood All Plants Pellets

- Easy to use all purpose feed
- Odourless pellet format - easy to apply
- Can be mixed in with compost or added to existing pots, beds etc as a feed
- 100% organic and nutrient rich
- Same features and benefits as Peat-Free Compost Booster Powder but in a pellet formula can be applied into the soil or used as a feed that is watered in
- 5-4-3 NPK



Product No	Size	Pack
ECF0099	800g	6

Peat-Free Compost Booster Powder

- 6 in 1 booster for happier, healthier plants, fruit and veg
- Up to 2x crop yields, and bigger, brighter blooms
- Strengthens the plant to help resist disease attack
- Supports plant during stress conditions i.e. heat, drought and overwatering
- Slow release of nutrients for long lasting support
- Improves water retention
- Improves root development
- With bio-stimulants
- Suitable for organic growing
- Feeds up to 40 plants



Product No	Size	Pack
ECF0101	800g	6

Natural Lawn Feed

- Natural formula, ideal for family lawns
- Quick and easy to apply with watering can or sprinkle bar
- The nutrients are taken up quickly, creating a lush, green lawn in no time
- Liquid concentrate treats up to 125m²



Product No	Size	Pack
ECF0043	1.25L	6

Organic Seaweed

- Produced from the best sources of organic seaweed
- Provides all plant types with an extra tonic boost
- 100% cold pressed
- Concentrate makes up to 50 watering cans



Product No	Size	Pack
ECF0082	1.5L	6

Basket & Tub Feed Concentrate

- High-quality organic-based liquid feed
- This feed encourages nutrient uptake to enhance plant development, promoting healthy and abundant growth
- Ideal for basket and tub grown flowers, fruits and vegetables
- Up to 50 watering cans



Product No	Size	Pack
ECF0098	1.5L	6

Natural Water Storing Granules

- Forms a gel around root systems that releases water to the roots, reducing the need for watering
- Stores 80 times its weight in water
- A blend of natural plant materials and minerals
- Biodegradable, non-toxic and odourless



Product No	Size	Pack
ECF0048	350g	6

Mould, Lichen & Green Algae Remover

- Fast acting and long lasting
- Biodegradable
- For paths, patios, fences and more
- Ready to use - covers up to 35m²



Product No	Size	Pack
ECF0084	5L	3

Black Spot Remover & Patio Restorer

- Coverage up to 25m²
- Works within 2 to 4 hours
- No scrubbing needed
- Restores back to natural colour
- Removes green growth including algae and lichen spores



Product No	Size	Pack
SPT15000	5L	4

Long Lasting Patio Cleaner

- Covers 220m²
- For paths, patios, block paving and stone
- Removes algae, mould and lichen spores
- Contains no bleach or acid



Product No	Size	Pack
SPT85000	5L	3

Path, Patio & Decking Cleaner Concentrate

- Apply and leave formula.
- Power to kill green algae
- 100% biodegradable ingredients
- Fast acting and long lasting
- Covers up to 70m²



Product No	Size	Pack
SPT362000	2L	6

External Mould, Green Algae & Fungi Killer

- Kills mould, green algae, and fungi
- Reduces regrowth for long periods
- Ready-to-use formula
- Covers up to 30m²



Product No	Size	Pack
SPT345000	5L	3

Outdoor Cleaning Fluid

- Removes algae from paths and patios
- Cleans and disinfects
- Deodorises drains and bins



Product No	Size	Pack
SPT71000	1L	6

Garden Slug Killer Pellets

- Certified for organic gardening
- Long lasting and effective in all weather
- Ideal for seedlings, plants and edibles
- Ferric phosphate formula – a natural active ingredient
- Bottle made from 100% recycled materials



Product No	Size	Pack
SPT310600	600g	6

NOT FOR SALE IN THE REPUBLIC OF IRELAND



10 Flush Park
Lisburn
Co Antrim
BT28 2DX

NI: +44 (0)28 9262 0300
ROI: +353 (0)1 840 3969
E: info@relay.global



RelayGlobal

www.relay.global



Relay Global is the trading name of Decor Ireland Ltd (no. NI607376)
Registered at: 10 Flush Park, Lisburn, Co Antrim, BT28 2DX